

门窗加工设备
Door&Window Machine

行业新标杆



SINON[®] 希能

铝门窗加工设备 / 幕墙加工设备 / 塑料门窗加工设备
Aluminum Win&Door Machine / Curtain wall Machine / PVC Win&Door Machine

铝门窗设备

LJQZ3-CNC-550×6500 铝型材智能锯切中心
Intelligent Sawing Machining Center for Aluminum Profile

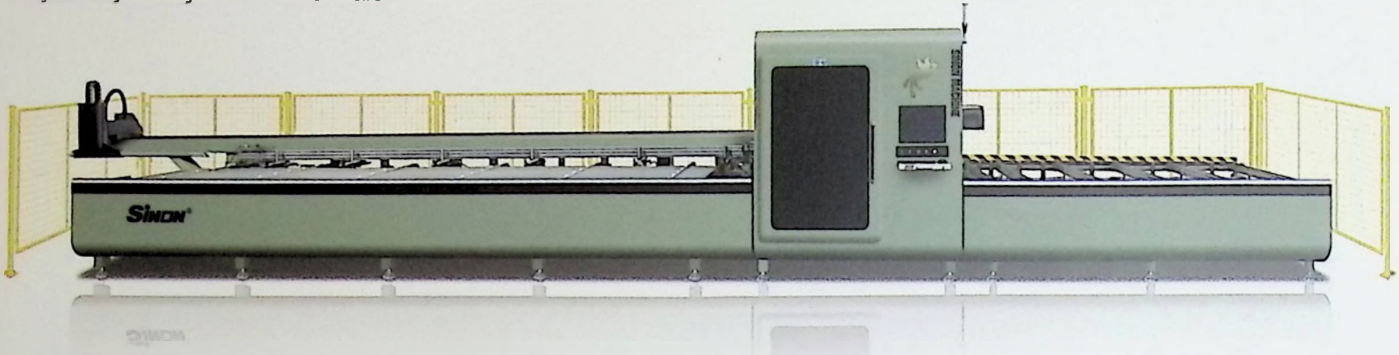

SZA600 智能框扇工作站
Intelligent Window Frame and Sash Workstation



SZA500 智能中梃工作站
Intelligent Mullion Workstation

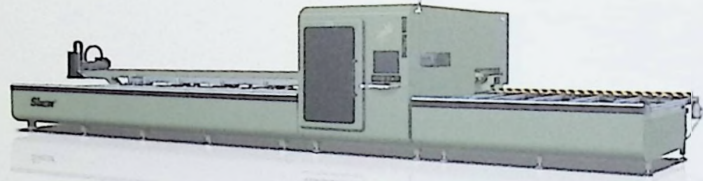

GSGZA-CNC-7000 高速四轴数控加工中心
High-speed 4-axis CNC Processing Center

可按客户要求定制尺寸

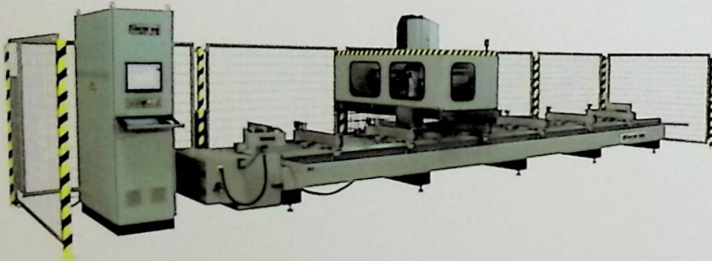

LJRZ2-CNC-500×6000 铝型材数控双头任意角精密切割锯床
Double Head Cutting Saw CNC for Aluminum Profiles

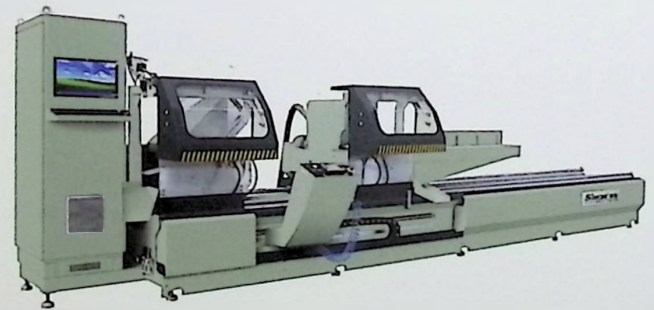

GCGZA-CNC-3000 铝型材数控四轴加工中心
CNC Four-axis Machining Center for Aluminum Profiles

可按客户要求定制尺寸

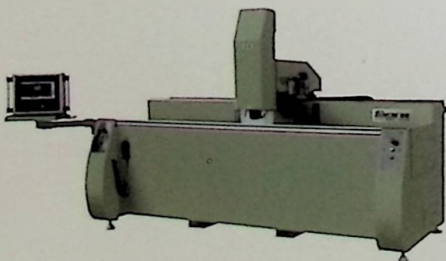

GCGZB-CNC-2500 铝型材数控钻铣加工中心
CNC Drilling and Milling Centers for Aluminum Profiles

可按客户要求定制尺寸

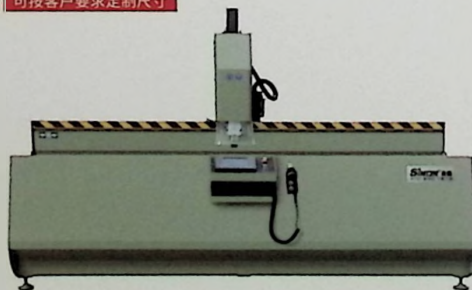

GCGZD-CNC-800 铝门窗数控钻铣床
CNC Drilling & Milling Machine for Aluminum Win-door

可按客户要求定制尺寸

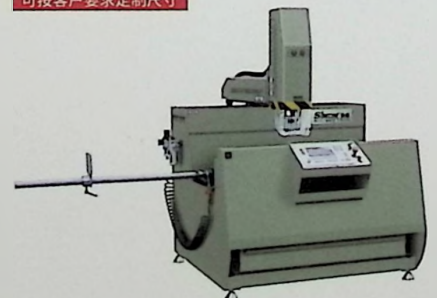

铝门窗设备

LJZ2N-CNC-550×5000 系统门窗超精密专用切割锯
Ultra Precision Special Cutting Saw for System Doors and Windows

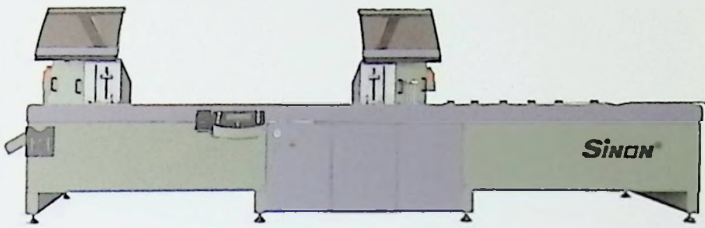

LJZ2D-CNC-500×4200 铝型材双头数控精密切割锯
Generation of Intelligent CNC Double Head Cutting Saw

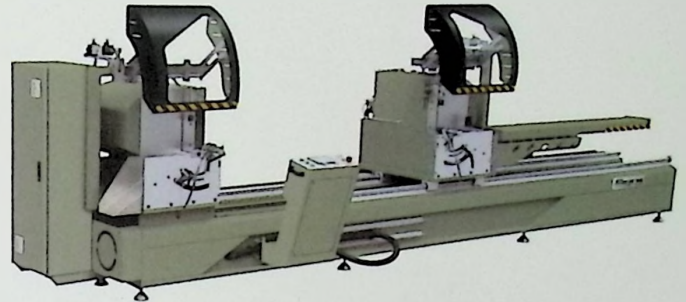

LJZ2C-CNC-500×4200 铝型材数控双头精密切割锯床
Double Head CNC Cutting Saw for Aluminum Profiles

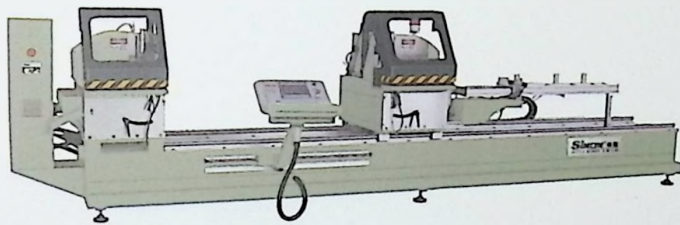

LJZ2F-CNC-550×4200 铝型材数控 45°专用双头精密切割锯床
LJZ2F-CNS-550×4200 铝型材数显 45°专用双头精密切割锯床
CNC 45° Special Double-head Precision Cutting Saw Machine for Aluminum Profile

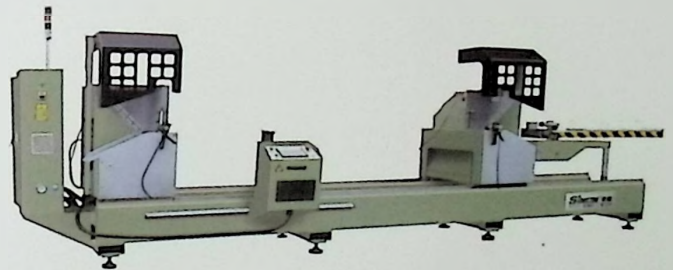

LJZ2B-CNS-500×4200 铝型材双头数显精密切割锯床
Double-head precision cutting saw CNS for aluminum profiles
LJZ2B-500×4200 铝型材双头精密切割锯床

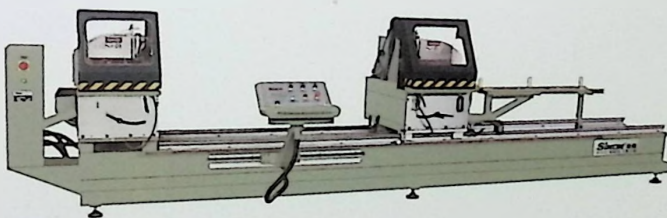

LJZ2A-CNS-500x4200 铝型材数显精密切割锯床
Double-head Precision Cutting Saw for Aluminum Profile
LJZ2-500×4200 铝型材双头精密切割锯床

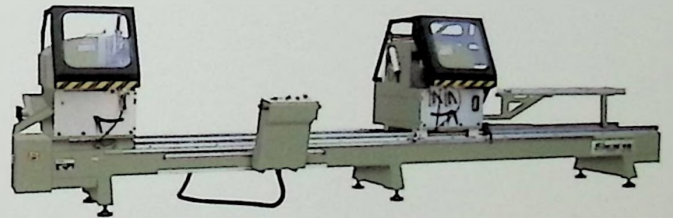

LJJ02-CNC-500 铝门窗数控角码切割锯
Corner Connector Automatic Cutting Saw

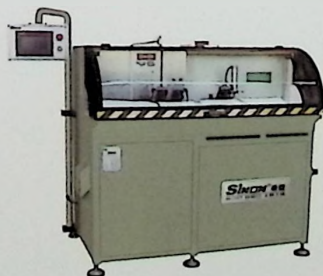

LJJ02A-CNC-500 铝门窗数控角码切割锯床
LJJ02A-500 铝门窗角码自动切割锯床
Corner Connector Automatic Cutting

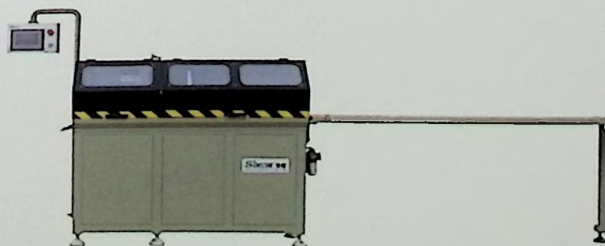

LJJ01-CNC-450 铝门窗数控角码切割锯床
LJJ01-450 铝门窗角码自动切割锯床
Corner Connector Automatic Cutting Saw



铝门窗设备

LJD02-500 铝型材重型单头切割锯
Heavy-duty single-head cutting saw for aluminum profiles



WJMD-650 铝型材任意角自动单头切割锯
Automatic single-head cutting saw for any angle of aluminum profile

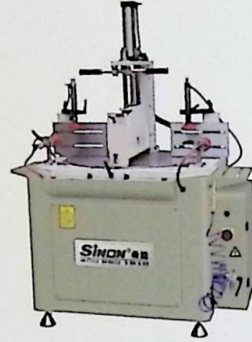

JL01 铝型材自动两维锯
Auto two-dimension saw for aluminum

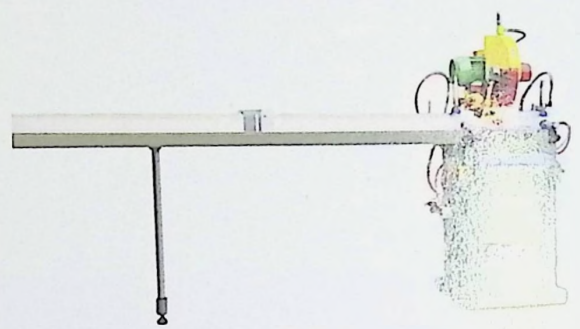

GDXZ2A-CNS-250 高效铝型材双头组合端面铣床
Double Head End Milling for Aluminum Profiles

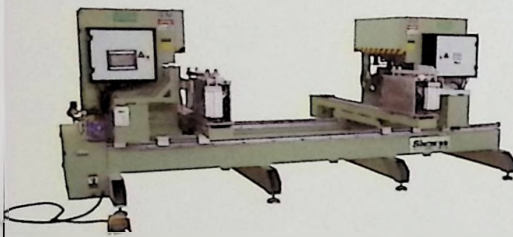

DX08-250 铝幕墙自动走刀铣榫机
Automatic Feeding Tenon Milling Machine

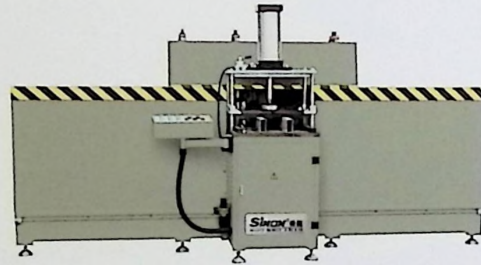

DX09-250 铝型材走刀组合端面铣床
Heavy Synchronous Corner Crimping Machine

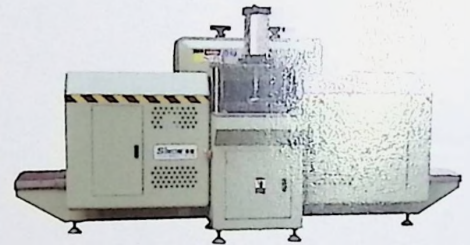

LJKJ-500 铝幕墙接口切割锯床
Aluminum Curtain Wall Notching Saw

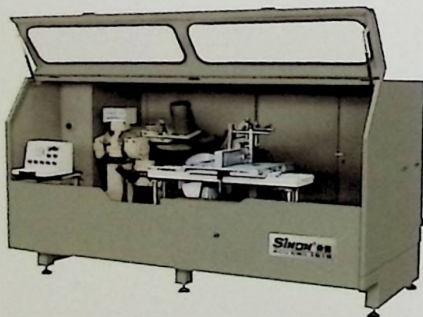

DX06A-250 铝型材立刀组合端面铣床
Heavy Synchronous Corner Crimping Machine

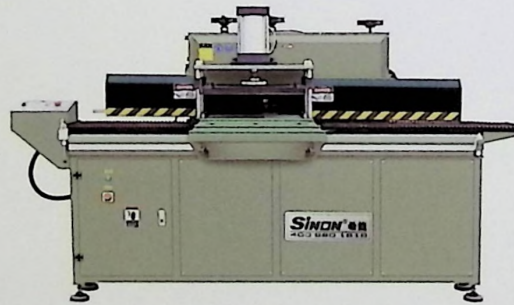

SSKC03-100 铝塑门窗锁孔槽加工机
Lock-hole Milling Machine for Aluminum and PVC Win-door

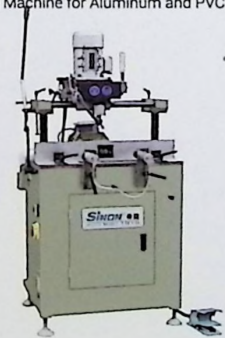

DX05-200 铝塑型材端面铣床
End Milling Machine

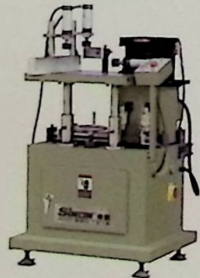

LDZX01-100 铝型材精密仿型铣床
Heavy Type Copy Routing Machine

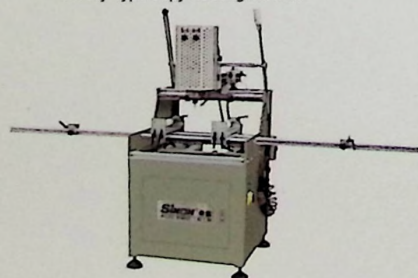

LSX01-100 铝塑型材双轴仿形铣床
Double Head Copying Routing Machine

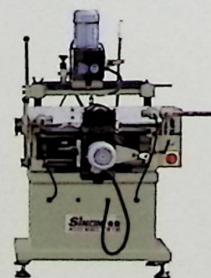

LSXZ1B-125 铝塑型材单轴仿形铣床
Single Head Copying Routing Machine

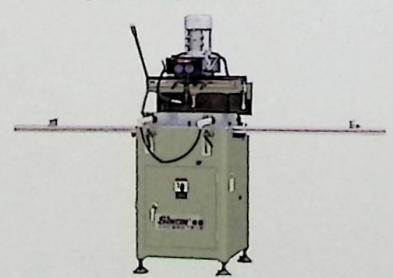

铝门窗设备

LZD6-130 铝型材多头组合钻床

Multi-head combined drilling machine for aluminum win-door

可按客户要求定制

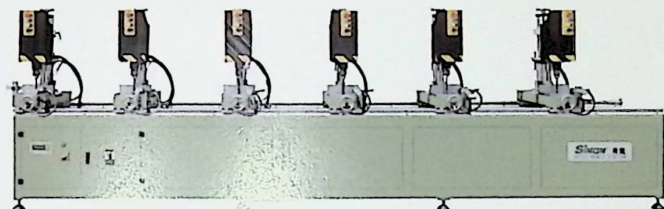

LJLZJ01 铝门窗铰链双头钻孔机

Horizontal Double Door Hinge Drilling

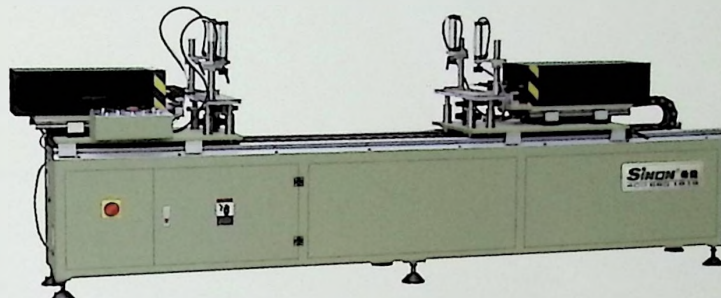

LZJZ4-CNC-100×1800×3000 铝门窗立式数控四头组角机

Four Head Corner Combining Machine CNC

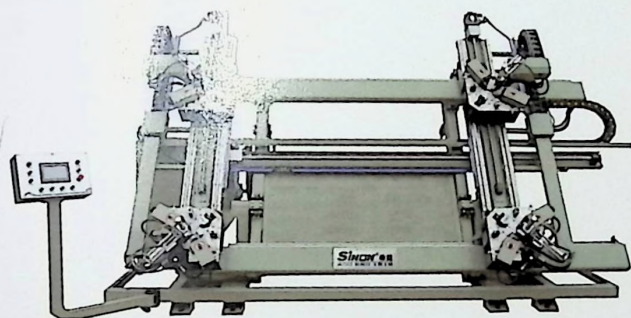

LZJ04-180

铝门窗重型同步组角机

Heavy Synchronous Corner Crimping Machine

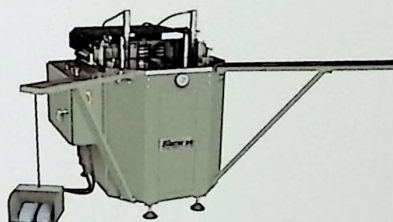

LZJ03-130

铝门窗组角机

Corner Combining Machine

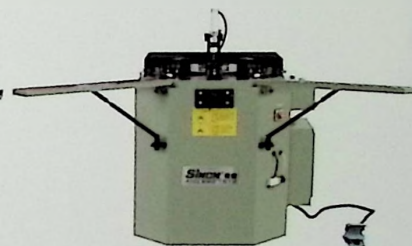

LYJ-75

铝门窗双立柱压力机

Double Column Punching Machine

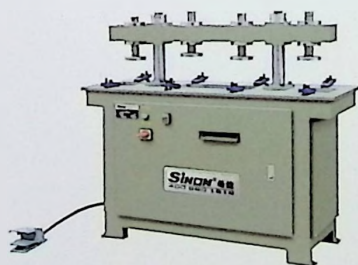

LYJ6-50

铝门窗转位压力机

Punching Machine

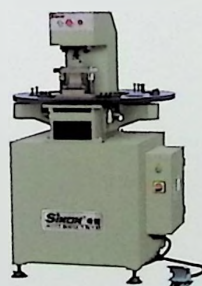

LYJ-B16

铝门窗压力机

Punching machine

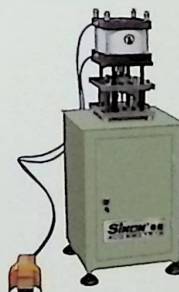

LYJ-50

铝门窗单头压力机

Single-head Press

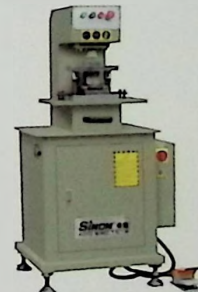

GYJ01-50

钢衬剪切压力机

Lining Steel Shearing Machine

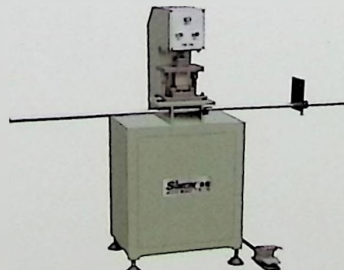

SFX02-160

塑料型材封盖铣床

Sealed Cover Milling Machine



LZT-B

铝型材中挺钻

Aluminum profile mullion drill



LXJ-03

铝型材立式铣筋机

Verticalmilling machine

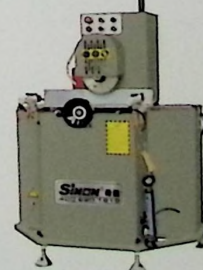

铝门窗设备 塑料门窗设备

LBYZT-B
数控百叶中挺钻一体机
CNC shutter stile drill integrated machine

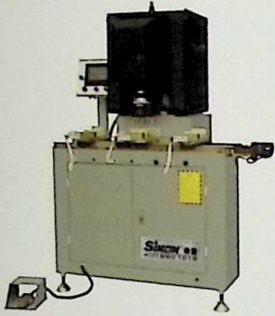

LLS-150D
立式锁盒机
Vertical lock box machine



LHH-A
护角锯
Angle guard saw

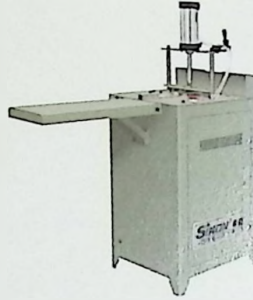

JMKC-2
角码开槽机
Angle code slotting machine

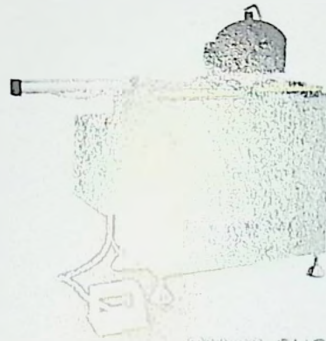

DLKC-A01
地漏排水开槽机
Floor drain drainage slotting machine

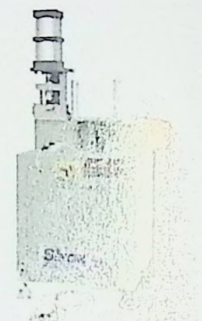

LKC01
铝型材开齿机
Gulleting machine

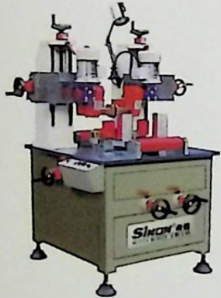

LCT01
铝型材穿条机
Assembly machine



LFH01
铝型材复合机
Composite machine



LWY02-CNC-100
铝型材卧式数控弯圆机
Aluminum profile type bending machine CNC

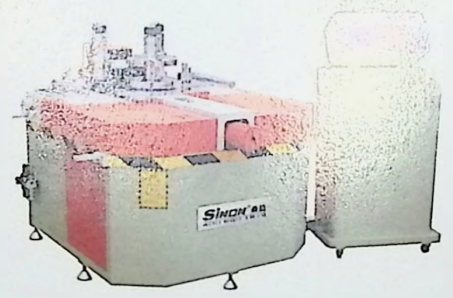

SHP4-CNC-180×1800×3000 塑料门窗立式数控四角焊接机
PVC Win-door Vertical CNC 4-corner Welding Machine

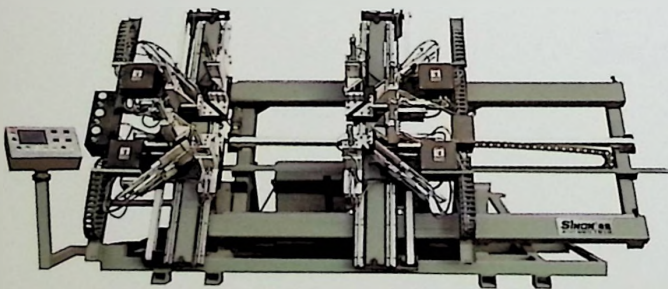

HJ-V4/HJ-V3/HJ-V2 塑料门窗全能焊接机 (无缝、有缝转无缝)
Four-head Welding Machine for Colorful PVC Win-door

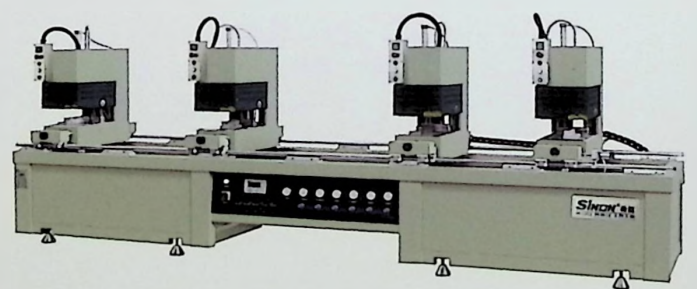

HJ02-4500.4/4A 塑料门窗四点焊接机
PVC Win-door 4-head Welding Machine

HJ02-3500.3/3A 塑料门窗三点焊接机

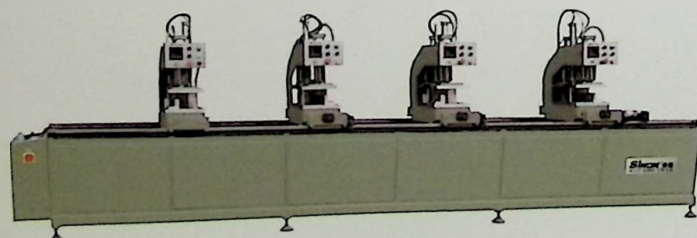

HJ02-3500.2/2A 塑料门窗二点焊接机
PVC Win-door 2-head Welding Machine

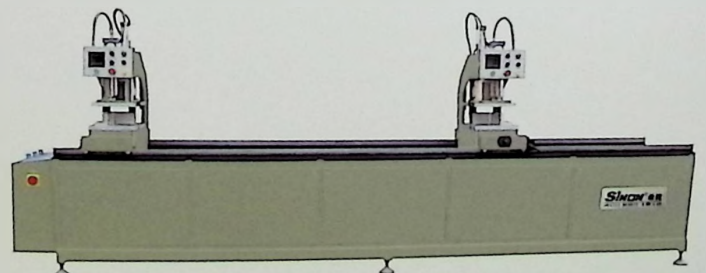

塑料门窗设备

SSJ07-450×3600
塑料型材专用双头切割锯床
Double-head Cutting Saw for Aluminum Profile

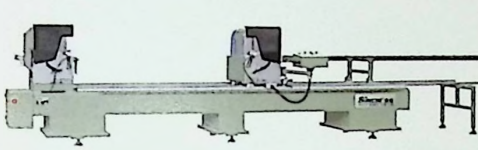

SSJ06-450×3700
铝塑型材双头切割锯床
Double Head Cutting Saw

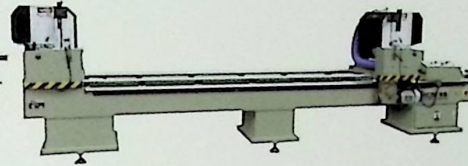

SJ02-3500 铝塑门窗双角锯床
Double-head cutting saw for aluminum and PVC profile



SJT03-420
塑料型材双头切割锯
PVC Win-door Double-head Cutting Saw



LJVW-60
铝塑型材 V 形锯
PVC Win-door V-cutting Saw



SYJ03-1800
铝塑门窗玻璃压条切割锯
PVC Win-door Glazing Bead Saw



SJT02-350
塑料型材中挺切割锯
PVC win-door mid-mullion cutting saw



SSK02-100 铝塑门窗锁孔槽加工机
Lock-hole Milling Machine

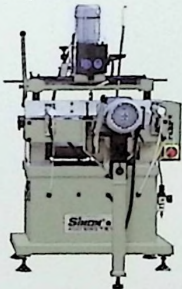

LSDX03-100 铝塑型材单轴仿形铣床
Single Head Copying Routing Machine



SCXZ2-60×120×3000 塑料型材双头水槽铣床
PVC Profile 2-head Auto Water-slot Milling Machine

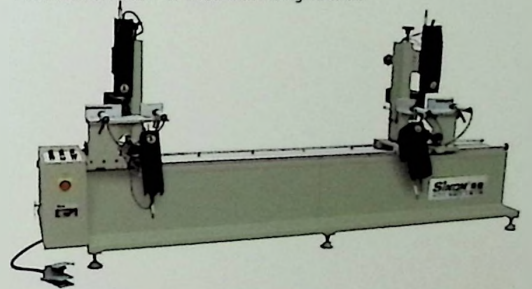

SCX03-3X60 塑料型材自动水槽铣床
PVC Profile Auto Water-slot Milling Machine

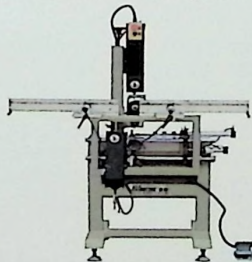

JQK04-CNC-120 塑料门窗数控角缝清理机
PVC Win-door Corner Cleaning Machine With CNC

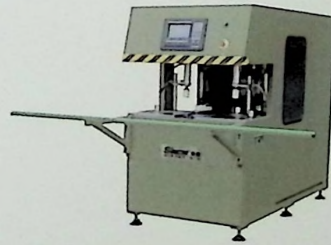

SYH1800 塑料型材圆弧机
PVC arch bending machine



SQJ05-120 塑料门窗 V 形角缝清理机
PVC Win-door V-corner Cleaning Machine

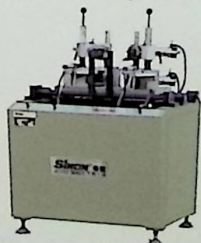

LDJZ1-CNC-6000 塑料门窗数控双区螺钉紧固机
CNC Double Zone Screw Tightening Machine for PVC Doors and Windows

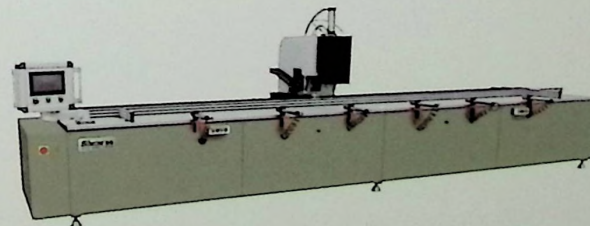

LDJZ4-120 塑料门窗螺钉紧固机
Reinforcement Screw Drilling Machine



© 2023 希能数控。保留所有权利。外观、型号、颜色变更的权利。如有变更恕不另行通知！



希能微信公众平台



希能中文网站



Sinon website

希能智能装备（山东）有限公司
SINON INTELLIGENT EQUIPMENT (SHANDONG) CO., LTD



400 680 1618

生产基地

地址：山东省齐河经济技术开发区园区北路 8 号 / 网址：www.sinoncnc.com
邮箱：sinoncnc@163.com

International trade department

Add: No. 8, North Park Road, Qihe Economic and Technological Development Zone, Shandong Province, China
Web: www.sinonmachine.com / Email: sinonmachine@gmail.com sales@sinonmachine.com / Skype: sinonmachine sinoncnc