



永利堅

永利堅鋁材

YONGLIJIAN ALUMINIUM

永恆創新 利益共享 誠信為本 精益求精

广东永利堅鋁業有限公司
GUANGDONG YONGLIJIAN ALUMINIUM CO.,LTD

產品目錄 (2021版)

公司简介

COMPANY PROFILE

“永利坚”商标创立于1986年。为了适应新时代的发展和需求，广东永利坚铝业有限公司董事会投入巨资搬迁，于2004年在佛山市高明沧江工业园建立了占地20万平方米的大型铝型材生产基地。充分整合和扩充了各种建筑用、装饰用和工业用等铝合金型材的生产，以及多种类的门窗、幕墙的设计、加工、安装施工等一系列的生产和服务。经过三十多年来的不断发展壮大，公司已经成为了一家国内大型的综合性铝合金型材生产企业。

时代的洪流，三十多载的春秋，见证了公司发展的轨迹，造就了永利坚的辉煌，公司积累了丰富的生产经验，在董事会的带领下，人才辈出，突飞猛进。在原有的基础上，公司进行了全面的整合，增资扩产，增加了国际先进的挤压生产线，氧化电泳生产线、喷涂生产线、氟碳喷涂生产线、木纹生产线、隔热生产线和深加工生产线。全面形成了管理体系的现代化及销售网络的优化组合，使产品达200多个系列，10000多种规格。通过加强工艺方面的研究，使各种合金牌号的合金工艺达到了和国际接轨的先进水平。成为了年生产各种铝合金型材的生产能力达十万吨以上，门窗幕墙制造能力达30万平方米以上的综合性企业。

永利坚铝业始终遵循“以人为本，追求卓越，全面发展”的宗旨，对各部门人才的培养非常重视，时至今日，永利坚凝聚了一大批高级技术人才，造就了一支“团结、务实、开拓、创新”的骨干团队，公司拥有高、中级技术人员200多名，在职员工1000多人。

凭借着企业雄厚的综合实力、强劲的创新能力和及其优质的产品和服务，“永利坚”牌铝材先后获得了国家质量方图认证，拥有国家幕墙设计和施工壹级资质证书。2007年被广东省科技厅授予“广东省高新技术企业”和“广东省民营科技企业”，2008年评审通过成为“广东省工程技术研究开发中心”。同年，由于本公司建立的标准体系结构合理，产品符合GB/T15496-2003、GB/T15497-2003、GB/T15498-2003国家标准要求达到AAA级，产品质量符合国家GB5237标准，日本JISH4100、JISH8601、JISH8602标准，美国AAMA2603、AAMA2604、AAMA2605标准，以及英国BS6496标准，先后荣获“省级企业技术中心”、“市级企业技术中心”等荣誉称号，并获得了国家级的专利几十多项和国际行业标准十多项专利的证书。

“永利坚”一作为中国改革开放史上的一个著名品牌，一贯以来都得到了全球用户的一致肯定，公司建立的产品销售网络遍及全球，分别与多国建立了贸易关系。

“永利坚”始终奉行“以质量求生存，以科技求创新，以规模求效益、以品牌求发展”的经营之道，重诚信、守信誉，持续改进，时刻把握市场的先机，实现产品的空间合理化、自然化、个性化。使产品创造出一个“时代化”的概念。多元化的品种、斑斓的色彩、通透的光泽及超强的耐腐蚀度，为广大客户创造出一个全新的生活空间。

“永恒创新，利益共享，坚定追求”是“永利坚”一贯的宗旨，充分体现到企业与国家，企业与客户，企业与员工一齐达到多赢共赢的经营之道，再接再厉为客户、为社会提供优质的产品和专业的售后服务。永利坚和您一起携手共进，共创美好和谐的未来！

永利坚—全球用户值得信赖的合作伙伴！



The "Yonglijian" trademark was founded in 1986. In 2004, in order to meet the development and demand of the new era, the directorate of Guangdong Yonglijian Aluminum Co., Ltd made huge investment in moving the company to Foshan Gaoming Cangjiang Industrial Park, where a large aluminum profiles production base covering an area of 200,000 square meters has been set up. We have integrated production of various architectural, decoration and industrial aluminum alloy profiles, etc. with a series of production and services ranging from design, processing to installation and construction of various doors, windows and curtain walls. Through over 30 years' constant development and expansion, the company has become a large comprehensive aluminum alloy profile manufacturing enterprise in the country.

Tides of the times and the over 30 years have witnessed the development of the company and achieved the brilliance of Yonglijian. The company has accumulated rich production experience. Led by the board of directors, large numbers of outstanding people have come forth and developed by leaps and bounds. The company has achieved comprehensive integration on the original basis, increasing investment and expanding production, increasing world-advanced extrusion lines, oxidation electro-coating lines, spray-coating lines, fluorocarbon spray coating lines, wood-grain production lines, heat-insulation lines and deep processing lines. It has fully



and a combination of ISO quality management system modernization
 sales network optimization, with over 200 series and over 10000 types
 products. It's now a comprehensive enterprise with annual production
 capacity of over 100,000 tons of various aluminum alloy profiles and over
 600 square meters of doors, windows and curtain walls.
 Yonglijian Aluminum always adheres to the tenet of "Human orientation,
 of excellence and comprehensive development", attaching utmost
 importance to cultivation of talents in all departments. Up till now, Yonglijian
 gathered a large group of senior technical talents, built a "United,
 artistic, pioneering and innovative" backbone team. The company has
 10 senior and middle technical talents and over 1000 workers.
 Relying on strong comprehensive force, strong innovation abilities,
 research abilities as well as quality products and excellent
 service, Yonglijian Aluminum has successively obtained CQM certificate
 for curtain wall design and construction Grade I qualification
 certificate, with products appraised by China Consumers Association as
 "Quality products". In 2007, the company was awarded by Guangdong
 Science and Technology Department as "Guangdong Province
 Private and New-Tech Enterprise" and "Guangdong Province Private
 and Technology Enterprise". In 2008, it was approved as
 "Guangdong Province Engineering Research and Development Center".
 In the same year, due to rational structure of the company's standard
 conformity of products with GB/T15496-2003, GB/T15497-2003
 and GB/T15498-2003 national standard Class AAA requirements, the
 company obtained "Standardization Excellent Behavior Certificate",
 "Quality System Certificate", "ISO14001 Environment
 Management System Certificate" and "QHSAS18001 Occupational Health
 and Safety Management System Certificate". Our product quality is up to
 GB25237 standard, Japanese JISH4100, JISH8601 and JISH8602

standards, US AAMA2603, AAMA2604 and AAMA2605 standards as well
 as UK BS6496 standard, we have won the honors of "China Well-known
 Trademark", "Provincial Enterprise Technology Center", "Municipal
 Enterprise Technology Center", etc. We have also obtained dozens of
 domestic and international patents.

Yonglijian, as a famous brand in the history of Chinese economic
 reform, has always been best recognized by global users. The company
 has built a product sales network covering the whole world and has built
 trade relationships with many countries.

Yonglijian always pursues the business way of "Surviving on quality,
 seeking innovation with science and technology, seeking benefit with
 large scale and seeking development with brand". We attach importance
 to promise and reputation, and we keep improvement and always seize
 market opportunities, to realize space rationalization, naturalization and
 personalization of products, to create a "era-oriented" product concept.
 Diversified product varieties, changing colors, crystal luster and super
 corrosion-resistance create an all-new living space for customers.

"Constant innovation, benefit sharing and persistent pursuit" is the
 unchanged tenet of Yonglijian, which fully represents the win-win-win
 business philosophy for the enterprise, the country, the customers and
 the staff. We are to make persistent efforts to provide customers and the
 society with quality products and professional after-sale
 services. Yonglijian advances hand in hand with you, to create a wonderful
 harmonious new future together!

Yonglijian—the trustworthy cooperative partner of global users!



● 展厅效果图

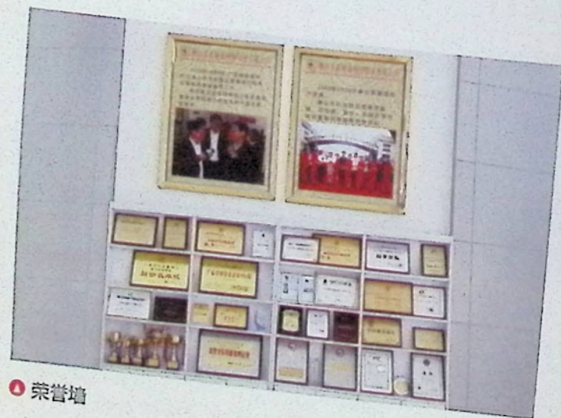

● 荣誉墙



● 展厅

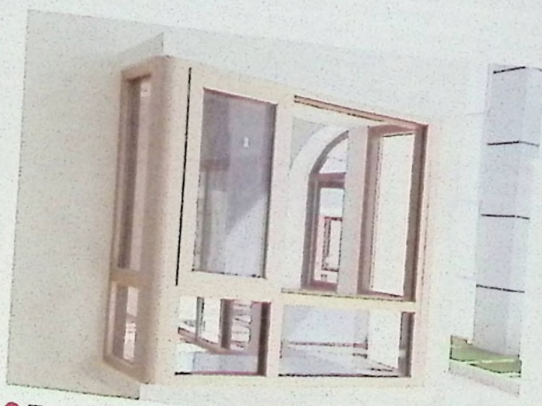

● 展厅

企业的核心价值

CORE VALUE OF ENTERPRISE

● 发展追求：

企业生产设备与国际先进水平同步或超越
 产品质量要求与国际先进水平同步或超越
 人才质素能力与国际先进水平同步或超越
 管理体系模式与国际先进水平同步或超越

● 经营理念：

以人为本，追求卓越、全面发展

● 企业宗旨：

永恒创新、利益共享、坚定追求

DEVELOPMENT PURSUIT:

Enterprise production equipment to keep pace with or surpass world-advanced level
 Product quality requirements to keep pace with or surpass world-advanced level
 Talent quality and capability to keep pace with or surpass world-advanced level
 Management system and mode to keep pace with or surpass world-advanced level

BUSINESS PHILOSOPHY:

Human-orientation, pursuit of excellence, comprehensive development

ENTERPRISE TENET:

Constant innovation, benefit sharing, unswerving pursuit



永利坚荣誉

YONGLIJIAN HONOR

诚者，天之道也；思诚者，人之道也。诚信是永利坚的命脉，是一切价值的根基。我们一直传奇着梦想，传奇着坚毅不倒的理念，传奇着永远永不磨灭的故事。

Integrity is the way of nature; pursuit of integrity is the way of people. Integrity is the lifeling of Yong Li Jian, and is the foundation of all value. We have been carrying forward the dream, the persevering concept, and the eternal story.



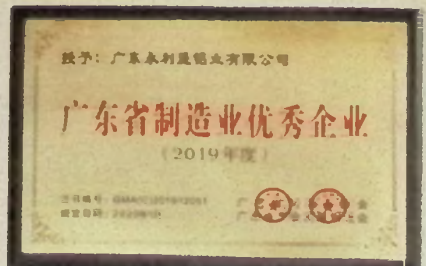
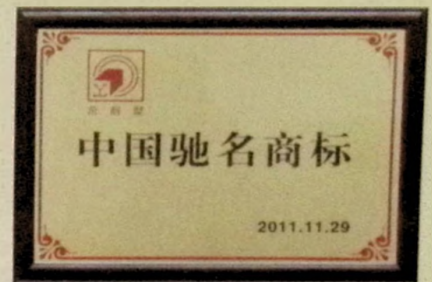
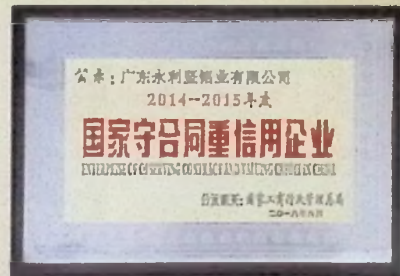



资质证书

QUALIFICATION CERTIFICATE



(2017)
编号: 4400 C 22333

采用国际标准产品标志证书

ADOPTING INTERNATIONAL STANDARD PRODUCT MARKING CERTIFICATE

广东永利铝业有限公司
你单位采用国际标准产品 铝合金门窗材料 电泳涂铝型材
经审查符合使用采用国际标准产品标志条件, 业已备案。
执行标准编号 GB 5237.3-2003
国际标准或国外先进标准编号 JIS S502, 2010
证书有效期 2017年 5月 2日至 2022年 5月 2日

This is to certify that your product Aluminum alloy extruded profiles for architecture adopting International Standard has been assessed to be qualified for using the adopting international standard product mark and has been registered.

Term of validity of this certificate from 2017 5 2 to 2022 5 2 inclusive.

 发证单位(盖章)
2017年5月2日

国家标准化管理委员会



(2017)
编号: 4400 C 22334

采用国际标准产品标志证书

ADOPTING INTERNATIONAL STANDARD PRODUCT MARKING CERTIFICATE

广东永利铝业有限公司
你单位采用国际标准产品 铝合金门窗材料 电泳涂铝型材
经审查符合使用采用国际标准产品标志条件, 业已备案。
执行标准编号 GB 5237.3-2003
国际标准或国外先进标准编号 JIS S502, 2010
证书有效期 2017年 5月 2日至 2022年 5月 2日

This is to certify that your product Aluminum alloy extruded profiles for architecture adopting International Standard has been assessed to be qualified for using the adopting international standard product mark and has been registered.

Term of validity of this certificate from 2017 5 2 to 2022 5 2 inclusive.

 国家标准化管理委员会



(2017)
编号: 4400 C 22344

采用国际标准产品标志证书

ADOPTING INTERNATIONAL STANDARD PRODUCT MARKING CERTIFICATE

广东永利铝业有限公司
你单位采用国际标准产品 铝合金门窗材料 电泳涂铝型材
经审查符合使用采用国际标准产品标志条件, 业已备案。
执行标准编号 GB 5237.3-2003
国际标准或国外先进标准编号 JIS S502, 2010
证书有效期 2017年 5月 2日至 2022年 5月 2日

This is to certify that your product Aluminum alloy extruded profiles for architecture adopting International Standard has been assessed to be qualified for using the adopting international standard product mark and has been registered.

Term of validity of this certificate from 2017 5 2 to 2022 5 2 inclusive.

 国家标准化管理委员会



(2017)
编号: 4400 C 22334

采用国际标准产品标志证书

ADOPTING INTERNATIONAL STANDARD PRODUCT MARKING CERTIFICATE

广东永利铝业有限公司
你单位采用国际标准产品 铝合金门窗材料 电泳涂铝型材
经审查符合使用采用国际标准产品标志条件, 业已备案。
执行标准编号 GB 5237.3-2003
国际标准或国外先进标准编号 JIS S502, 2010
证书有效期 2017年 5月 2日至 2022年 5月 2日

This is to certify that your product Aluminum alloy extruded profiles for architecture adopting International Standard has been assessed to be qualified for using the adopting international standard product mark and has been registered.

Term of validity of this certificate from 2017 5 2 to 2022 5 2 inclusive.

 国家标准化管理委员会



(2017)
编号: 4400 C 22344

采用国际标准产品标志证书

ADOPTING INTERNATIONAL STANDARD PRODUCT MARKING CERTIFICATE

广东永利铝业有限公司
你单位采用国际标准产品 铝合金门窗材料 电泳涂铝型材
经审查符合使用采用国际标准产品标志条件, 业已备案。
执行标准编号 GB 5237.3-2003
国际标准或国外先进标准编号 JIS S502, 2010
证书有效期 2017年 5月 2日至 2022年 5月 2日

This is to certify that your product Aluminum alloy extruded profiles for architecture adopting International Standard has been assessed to be qualified for using the adopting international standard product mark and has been registered.

Term of validity of this certificate from 2017 5 2 to 2022 5 2 inclusive.

 国家标准化管理委员会

永利坚秉承“诚信经营，科技创新”的理念。产品通过了国家和地区的各种认证书，并充分得到市场认可，这也成为了与客户建立良好且持久合作关系的基础。

Yong Li Jian adheres to concept of "Uncompromising Integrity and technological Innovation". Our products have passed different national and regional certifications, and have won full recognition of the market, which is also the best support for establishing excellent and lasting cooperative relationships with customers.





① 熔铸



② 氧化

先进设备

ADVANCED EQUIPMENT



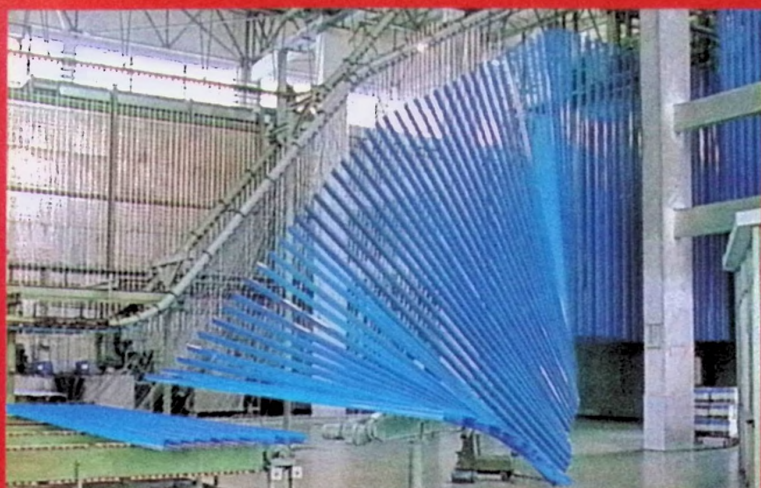

● 喷涂



● 隔热

最先进的生产设备，最严谨的生产流程，最专业的技术工程师，只为打造最具品质的产品。我们站在行业的尖端，并将引领着未来。

The most advanced production equipment, the most stringent production process and the most professional technical engineers, all are only to create the best quality products. We stand in the forefront of the industry, and we will be leading the future.



检测设备

TEST EQUIPMENT

永利坚创立30年来，一直重视产品品质。从铝原料采购，到产品完美成型，再到仓储物流，永利坚依托先进的卓越绩效管理体系，在精细管理和品质监控上力争完美，以关键点控制法进行品质管理和现场管理，责任落实到人，有效追踪品质监控全程。

For 30 years since its establishment, Yonglijian has always been attaching importance to product quality. From purchasing of aluminum raw materials, to perfect forming of products, and to warehousing and logistics, Yonglijian relies on advanced and outstanding performance management system to strive for perfection in fine management and quality control, and bases on key point control method to carry out quality management and on-site management, to assign responsibility to each employee, to effectively track total quality control.



● 杯突试验仪



● 色差计



● 金相试样抛光机



● 电子万能试验机



● 生化培养箱



● 紫外灯人工气候老化仪



① 数显小负荷维氏硬度计



① 电子分析天平



① 金相显微镜



① 直读光谱仪



① 仪表车床



① 人造气氛腐蚀盐雾箱



① 恒温恒湿箱



① 干燥箱



铝合金型材化学成分

General Chemical Composition of Alloy

合金牌号 alloy	Si	Mg	Fe	Cu	Mn	Zn	Cr	Ti	其它杂质 Impurity		Al 余量 Remainder
									单个 Unit	合计 Total	
6061 (%)	0.40-0.8	0.8-1.2	<0.7	0.15-0.40	<0.15	<0.25	0.04-0.35	<0.15	<0.05	<0.15	余量 Remainder
6063 (%)	0.20-0.6	0.45-0.9	<0.35	<0.10	<0.10	<0.10	<0.10	<0.10	<0.05	<0.15	余量 Remainder
6063A	0.30-0.6	0.6-0.9	0.15-0.35	<0.10	<0.15	<0.15	<0.05	<0.10	<0.05	<0.15	余量 Remainder

铝合金型材室温力学性能

Mechanical Properties of Sections under Room Temperature

合金牌号 Alloy	状态 Temper	拉伸实验(Tensile strength test)				硬度实验(Hardness test)		
		壁厚 / (mm)	抗拉强度 Tensile strength RM/(N/mm ²)	规定非比例延伸强度 Non-proportional Stretching Stress Rp0.2/(N/mm ²)	伸长率1% Stretching rate A50mm	试样厚度 Pattern Thickness (mm)	维氏硬度 HV	韦氏硬度 HW
6061	T4	所有	≥ 180	≥ 110	≥ 16	-	-	-
	T6	所有	≥ 265	≥ 245	≥ 8	-	-	-
6063	T5	所有	≥ 160	≥ 110	≥ 8	≥ 0.8	≥ 58	≥ 8
	T6	所有	≥ 205	≥ 180	≥ 8	-	-	-
6063A	T5	≤ 10	≥ 200	≥ 160	≥ 5	≥ 0.8	≥ 65	≥ 10
		>10	≥ 190	≥ 150	≥ 5			
	T6	≤ 10	≥ 230	≥ 190	≥ 5			
		>10	≥ 220	≥ 180	≥ 4			

铝合金型材阳极氧化表面处理

Anodisation Of Aluminium Profiles

膜厚级别 Film thickness grade	平均膜厚/μm, 不小于 Average film thickness/μm, No less than	局部膜厚/μm, 不小于 local film thickness/μm, No less than
AA10	10	8
AA15	15	12
AA20	20	16
AA25	25	20

注：氧化膜厚度一般按AA10级
Note: The anodized aluminium

按客户要求的膜厚生产。
supplied in grade AA10 or according to customer's requirement

铝合金型材电泳涂漆表面处理

Electrophoresis Of Aluminium Profiles Finishing

膜厚级别 Film thickness grade	膜厚/ μm (Film thickness/ μm)		
	阳极氧化膜局部膜厚 Local thickness of anodic film	漆膜局部膜厚 Local thickness of coating	复合膜局部膜厚 Local thickness of composite film
A	≥ 9	≥ 12	≥ 21
B	≥ 9	≥ 7	≥ 16
S	≥ 6	≥ 15	≥ 21

注：电泳涂漆型材一般按B级供货，也可按客户要求供应其它级别型材。

Note: The quality of electrophoresis aluminium is confirmed with grade B, or others according to customers' choice.

铝合金型材氟碳漆喷涂表面处理

Fluorocarbon spray coating Of Aluminium Profiles Finishing

涂层种类 Type of coating	平均膜厚/ μm Average film thickness/ μm	最小局部膜厚/ μm Minimum local film thickness/ μm
二涂 (Two coating)	≥ 30	≥ 25
三涂 (Three coating)	≥ 40	≥ 34
四涂 (Four coating)	≥ 65	≥ 55

注：由于挤压型材横截面形状的复杂性，在型材某些表面（如内角、横沟等）的漆膜厚度允许低于以上的规定值，但不允许出现露底现象。

Note: Due to complexity of cross-sectional shapes of extruded profiles, coating thickness at certain surface of profiles (like inner angle, transverse trench, etc.) is allowed to be lower than the above-mentioned specified value. But expose base is not allowed.

最大型材挤压尺寸

The Most Daxingcai Extrusion Size

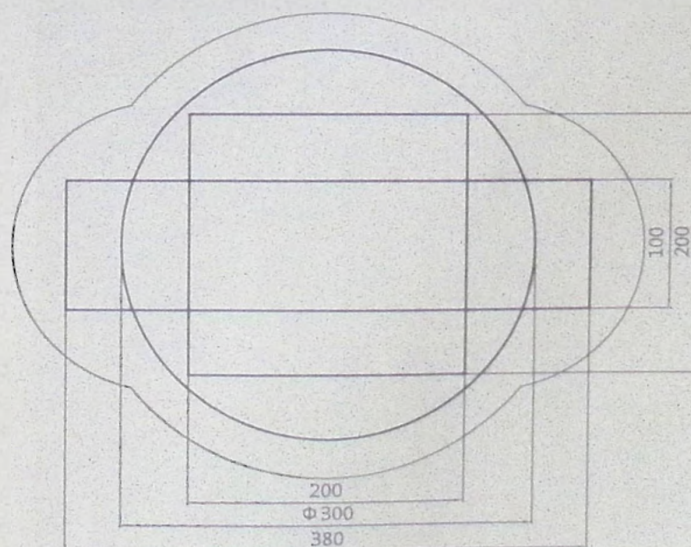

可出型材：
圆管 $\phi 300$
方管 200×200
扁管 380×100



永利堅

部分工程实例

SOME ENGINEERING EXAMPLES

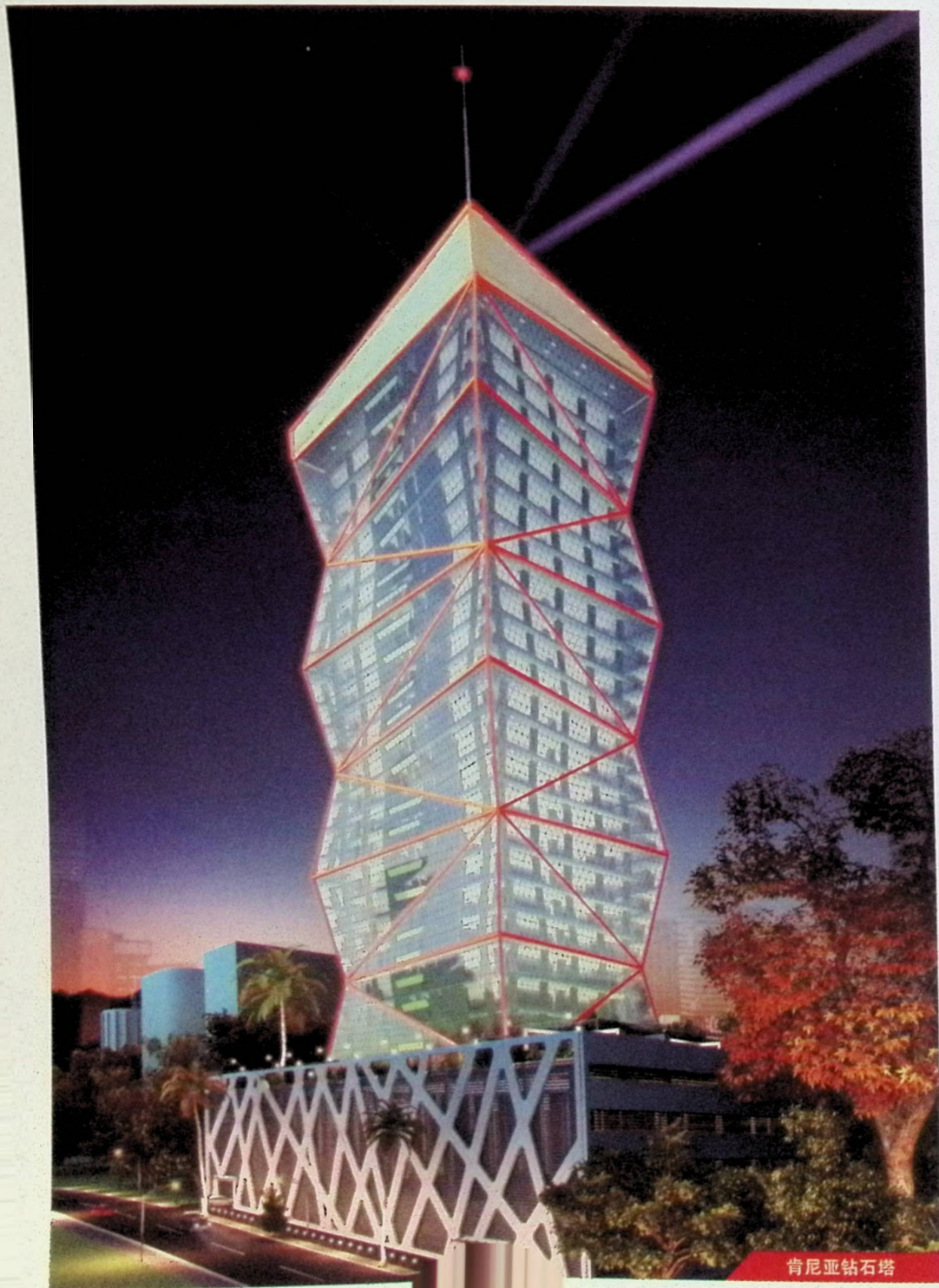

肯尼亚钻石塔



河源时代广场



温州工商银行牛山国际城市综合体



永利 堅



白天鹅宾馆

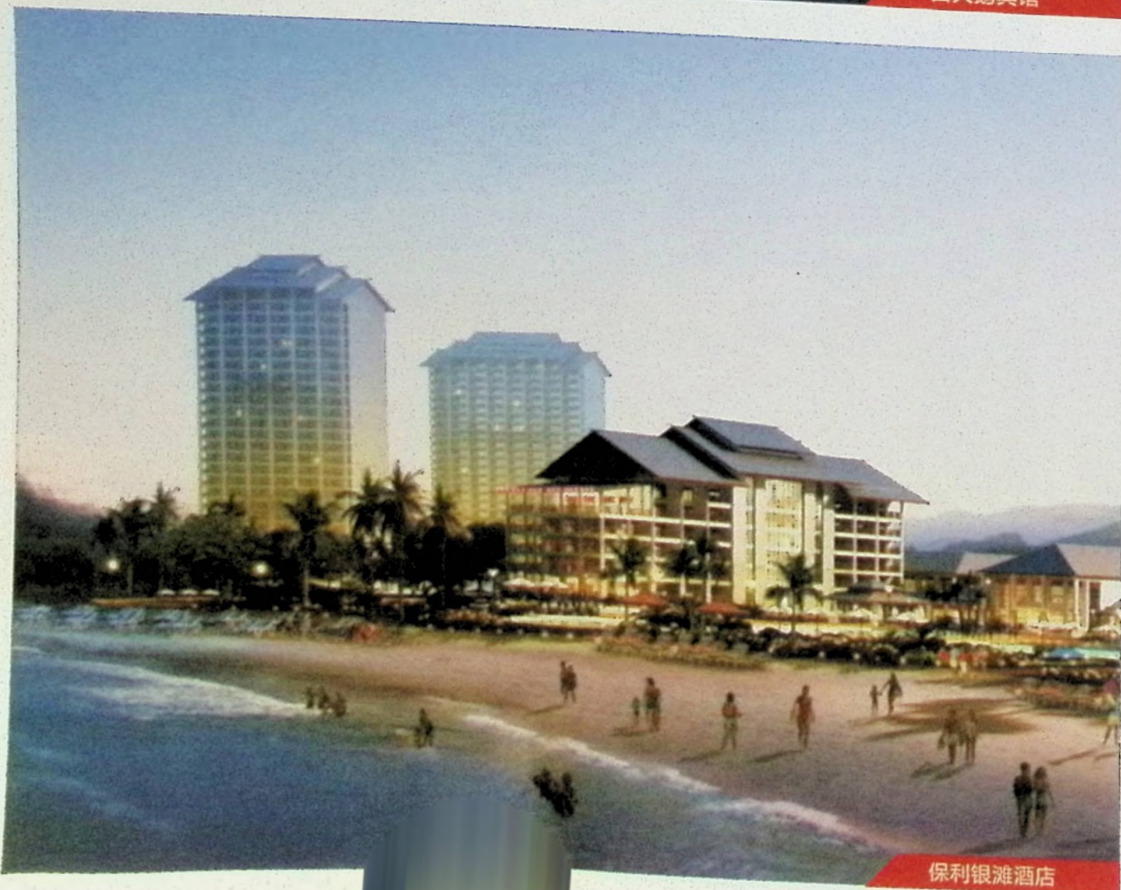

保利银滩酒店



荣盛商务大厦





深圳壹方中心



广外图书馆

部分工程名录

PART OF THE PROJECT DIRECTORY

海外工程：

吉布瓦-埃塞俄比亚铁路
肯尼亚钻石塔
肯尼亚UAF门窗幕墙
肯尼亚MT住宅区
菲律宾Hotel Luana
菲律宾The Ivy Wall hotel
菲律宾 Camella Condo Homes-Katipunan
菲律宾 Symphony Towers Condominium
菲律宾德恩德俊海度假村
菲律宾APPLE ONE酒店
加拿大tom condo大楼
卢旺达大学
卢旺达MSC商业大楼
尼日利亚酒店SKYLIGHT
布隆迪医院
加纳GHANA商业广场
加纳库马西办公大楼
加纳加纳新址
俄罗斯UAP赤道大厦门窗幕墙
南苏丹日出公寓
安哥拉KA五星酒店
安哥拉警察局
新加坡裕廊岛
新加坡印度国际学校
柬埔寨米拉酒店

直辖市及特别行政区：

北京哥博会
北京地铁大兴线枣园路站
上海宝山检察院
上海周浦地铁站
上海中央公园
上海久阳文华府
重庆邦海大学
重庆新新大卫星
重庆大学城中央花园
重庆黔江民族风情城
重庆时代广场
重庆国金国际
重庆心翼天下
重庆世纪花园别墅
重庆永隆美湖山水
重庆南方玫瑰城
重庆锦江华府
中铝重工华渝机电
中铝重工清平机械厂
港珠澳大桥人工岛
香港盛佳治大厦
香港北角酒店
香港浸会大学
澳门机场
澳门渔人码头
澳门威尼斯人酒店

广州：

广州星海音乐厅
广东外语外贸大学图书馆
广东省工商银行
广东省中医院大学城医院
广州科学城综合研发孵化区
广州花都祈福机场酒店
广东沙东有利服装城

广州迎亚运旧城改造
广州东湖广场
广东省花城企业有限公司
广州荔尚国际大厦
广州清华科技园
广州创新基地
广州番禺时代广场
广州市镇证大厦
广州百汇广场
广州国信大厦
广州黄金广场
花城御桂园（假日半岛）

深圳：

深圳技师学院
南方科技学院
深圳润都影城
深圳华侨城
深圳警方中心
深圳永翰实验学校
深圳龙华文化广场
深圳纯水岸
深圳地王广场
深圳翠湖御园
深圳市前海地铁上盖保障房
深圳假日海畔酒店
深圳欢乐海岸
深圳龙岗万科天誉
深圳沙井高秀酒店

佛山：

佛山火车站
佛山消防局
广东省纺织学院（高明）
顺德华侨城
三水百利达广场
三水万达广场
广东外语外贸大学高明校区
高明地税局
佛山世博城
佛山佛罗里达广场
佛山金海湾创新中心
佛山禅城九鼎国际城
南海喜地景
南海海天科技城
佛山岭南大厦
佛山国际大酒店
佛山发展大厦
佛山雅居乐
高明南车项目基地
高明五福酒店
高明明都广场
佛山高明京柏城
佛山高明中港广场
佛山高明碧桂园海城
高明西江实验小学

江门：

江门汽车总站
邮政储蓄银行大厦
江门车行世界汽配城
国瑞汇悦城
国瑞领秀
健威广场

海逸城邦/海逸星辰/海逸峰璟
龙溪新城
益丞艾迪公寓/益丞富隆居
新英世贸广场
上城嘉泰
滨港御城/尚城美居
江海花园二期/江海怡景湾/又一层/朗晴新天地
柏佳园尚品/柏佳园世悦/柏佳园绿茵高尔夫/柏佳园天玥
岭南印象/昇悦居
帝京尚品汇/凯茵豪庭/洋湾蓝湾(会所)
上城摩卡/青都上院/恒健大厦/世纪花苑/北苑小区
恒骏花园
潮连中心学校/双朗小学/木朗小学
缤采动漫总部大楼/朗廷酒店/金兴楼
金凯皇大模(陈西智谷大楼)/恒基厂房
地尔·汉宇电器生产大楼
量子高科(微生态产业基地)大型厂房
安浩待办公大楼/金钻待办公大楼/大型厂房
江沙示范产业园(微特电器、滨崎食品)办公大楼/大型厂房
新会人民医院新住院大楼
新会玉湖度假村
新会碧翠华庭/新会名商华府
新会海逸庭轩
广东科隆生物科技大楼/92962 部队生活大楼
鹤山新华城
鹤山柏佳园/尚城雅苑
鹤山文汇华府/鹤山龙菊花园/鹤山聚隆苑
鹤山新奥瑞工业园/鹤山迪克印材厂房
台山中环广场
台山红木艺术展览城
台山金碧湾大酒店
恩平锦江国际新城/丽湖国际大酒店/逸豪酒店/益华百货

广东省其他地方：

厦深高铁站
大亚湾石化公司
珠海长隆海洋王国
珠海横琴澳门中心
珠海华发水郡花园
韶关市印务稽查旅游配套设施项目
韶关火车站
韶关联通大厦
韶关欧润御龙湾
韶关星河湾
韶关百年东街
新兴湖国际花园
新兴沿江明珠
中山星汇云锦花园
中山科技创业园
清远新亚植物园
清远佛冈妇幼保健院
清远佛冈县国际御景峰
东莞市东涌镇华南湿地公园综合球馆
肇庆鸿景观园
肇庆市委宿舍楼
封开汇景城
云浮石材城
惠州中央华府
惠来县人民政府办公楼
河源妇幼保健院
德州幸福里花园
潮州天城山庄
汕头渔人码头
汕头农业银行
汕头欧翼汽车城



汕头潮南嘉信广场
 汕头金银岛别墅
 汕头小商品批发市场
 汕头中海信创新产业园
 汕尾海丰梅兴小学
 阳春市东湖国际花园
 阳春市旗峰花园
 阳春人民医院
 阳春公安局
 阳江锦湖花园
 湛江君临世纪花园
 湛江霞山法院
 湛江金海湾
 琼岭环保科技楼
 廉江采霞花园
 信宜龙庭花园
 陆丰华源新都
 陆丰东海镇金碧豪庭
 陆丰福利院
 普宁康美医院
 普宁中药城
 普宁国际商贸城
 普宁广场
 普宁池尾电信大楼
 茂名城光世纪城
 茂名顺佳雅苑
 茂名电白六招珠宝创意产业园

浙江省：

浙江省信息化测绘创新基地
 温州火车站
 温州机场
 温州检察院
 温州机关事务管理局
 浙江旗沙基地
 邵阳红星美凯龙
 泰昌输变电产业园
 万科城市之光
 温州城建指挥部大楼
 温州长江汽车城
 温州滨海大酒店
 温州国际金融中心
 乐清第二人民医院
 乐清雁荡小镇
 温州御真家庭
 海西工业园
 温州中江广场
 温州万象城
 温州牛山国际城
 温州国际金融中心
 温州邮政大楼
 临安中都水岸
 开化天玺酒店
 杭州萧山生态园
 浙江义乌中都御金园
 杭州融科瑰澜山
 宁波滨江国际学校

广西省：

钦州大学城
 桂林税务局办公楼
 南宁职业技术学院
 南宁五中体育馆
 南宁奇石博物馆

北海海事局大楼
 北海党校
 阳朔益田西街
 百色三祺龙景国际
 灵山县浙商国际新城
 都安密洛陀度假大酒店
 南宁吴山街安置房
 广西玉林湿地公园
 桂西制药有限公司
 南宁荣和山水绿城
 南宁国际财富广场
 南宁城市学院
 南宁中国人保大厦
 南宁职业技术学院工程
 河池西站

四川省：

成都富豪酒店
 成都西部酒店
 成都怡湖玫瑰苑
 九寨沟悦榕庄酒店

海南省：

海南观澜湖
 海南电视台
 海口市建设厅
 海口海南生态软件园
 海口海南师范大学
 海口宝安江南城
 海口保利秀英港
 海口睿智花苑
 海南三业力合酒店
 海南三业理想海岸
 海口南国中心
 海南白沙棋子湾
 三亚市亚龙湾椰树路别墅
 陵水新村绿城
 博鳌美丽熙海岸
 琼海兆南丽湾

云南省：

云南华山顺科医院
 云南丽江温泉小镇
 云南西双版纳喜来登大酒店
 云南滇池派居
 云南玉溪第二人民医院
 昆明财富中心
 大理论坛展示中心
 大理密湾
 云南芒市弘映山庄

湖南省：

湖南交通设计院
 长沙泊金馆
 湖南长沙湘雅医院
 湖南衡阳银泰红城
 湖南衡阳高铁学院
 湖南衡阳市一中体艺馆
 湖南衡阳鸿泰城
 湖南衡阳御笔华章
 湖南祁东公安局
 湖南郴州医专附属医院
 湖南郴州新贵华城

湖南郴州锦绣银河
 湖南邵阳湘中广场
 湖南湘江世纪城
 湖南宜章影视文化广场
 湖南张家界华天城
 张家界大熊山水国际酒店
 常德市武陵文化产业园
 常德澧县人民医院

其他省份：

沈阳远洋和平苑
 洛阳机场飞行大厦
 郑州雅居乐
 南京合源欣业金融软件园
 南京汤氏园林
 南京地铁3号线武定门站
 南京三桥滨江泵站
 苏州湖马湖别墅
 苏州金鸡湖湖景号别墅
 龙潭镇镇电子商务产业园
 江苏扬州中国唐园
 江西金县行政中心
 江西吉安义乌小商品城
 江西宜春奉新城
 山西晋中航天城
 山东淄博农业博览园
 山东东营别墅
 湖北宜昌移民局
 武汉中国船舶重工701研究所(原船)湖
 湖北恩施利川基斯堡大别墅(5星)
 西安雍园会所
 西安第三医院
 贵阳未来方舟
 贵州遵义遵义道真温泉
 贵州毕节城市花廊
 贵阳黔江民族陵园
 厦门高崎港业休闲度假区
 厦门交通规划院信息中心
 厦门湾湾水利局
 厦门海沧长裕西霞楼
 福建晋江中内各番番
 福建宁德湖神陵园
 福建宁德宁德少年宫
 宁夏神华宁夏煤业集团基地综合办公楼



1、推拉窗系列

①. 70系列推拉窗 Series 70 Sliding Window	001-009
②. 80B系列推拉窗 Series 80B Sliding Window	010-017
③. 82系列推拉窗 Series 82 Sliding Window	018-024
④. 85系列推拉窗 Series 85 Sliding Window	025-034
⑤. 85A系列推拉窗 Series 85A Sliding Window	035-040
⑥. 88系列推拉窗 Series 88 Sliding Window	041-044
⑦. 88C系列推拉窗 Series 88C Sliding Window	045-049
⑧. 90系列推拉窗 Series 90 Sliding Window	050-059
⑨. 788系列推拉窗 Series 788 Sliding Window	060-070
⑩. 2008J系列推拉窗(专供) Series 2008J Sliding Window (Exclusive)	071-075
⑪. 100系列推拉窗 Series 100 Sliding Window	076-078
⑫. 898系列推拉窗 Series 898 Sliding Window	079-084
⑬. 108A系列推拉窗 Series 108A Sliding Window	085-086

2、平开窗系列

①. 38系列平开窗 Series 38 Casement Window	087-096
②. 50系列平开窗 Series 50 Casement Window	097-118
③. 50E系列平开窗 Series 50E Casement Window	119-127
④. 50G系列平开窗 Series 50G Casement Window	128-130
⑤. 65系列平开窗 Series 65 Casement Window	131-137
⑥. 70系列平开窗 Series 70 Casement Window	138-142

3、门系列

①. 46系列地弹门 Series 46 Spring Door	143-147
②. 50系列平开门 Series 50 Casement Door	148-156
③. 70系列平开门 Series 70 Casement Door	157-170
④. 72系列推拉门 Series 72 Sliding Door	171-174
⑤. 85系列推拉门 Series 85 Sliding Door	175-186
⑥. 88A系列推拉门 Series 88A Sliding Door	187-196
⑦. 90系列推拉门 Series 90 Sliding Door	197-199
⑧. 82系列平开门 Series 82 Casement Door	200-203
⑨. 85、130系列推拉门 Series 85、130 Sliding Door	204-209
⑩. 120、185系列重型推拉门 Series 120、185 Heavy Sliding Door	210-215



4、常规标准型材

①. 间隔管 Diagram of Spacer Tube	216-226
②. 百叶YLJ840 Louvre YLJ840	227-236
③. 栏杆.扶手YLJ820 Railing.Handrail YLJ820	237-285
④. 扁管铝合金 Lat Tube Aluminum Alloy Profiles	286-292
⑤. 槽铝合金 Slot Aluminum Alloy Profiles	293-295
⑥. 角类铝合 Angle Aluminum Alloy Profiles	296-300
⑦. T字、开口管铝合金 T-Shaped/open Tube Aluminum Alloy Profiles	301-301
⑧. 扁条铝合金 Flat Bar Aluminum Alloy Profiles	302-304
⑨. 方管铝合金 Square Tubes Aluminum Alloy Profiles	305-307
⑩. 圆管铝合金 Round Tube Aluminum Alloy Profiles	308-311
⑪. 纱窗料总汇 Screen Window	312-313
⑫. 角码总汇 Connectors	314-316
⑬. 转角管型材 Coupling Profiles	317-317

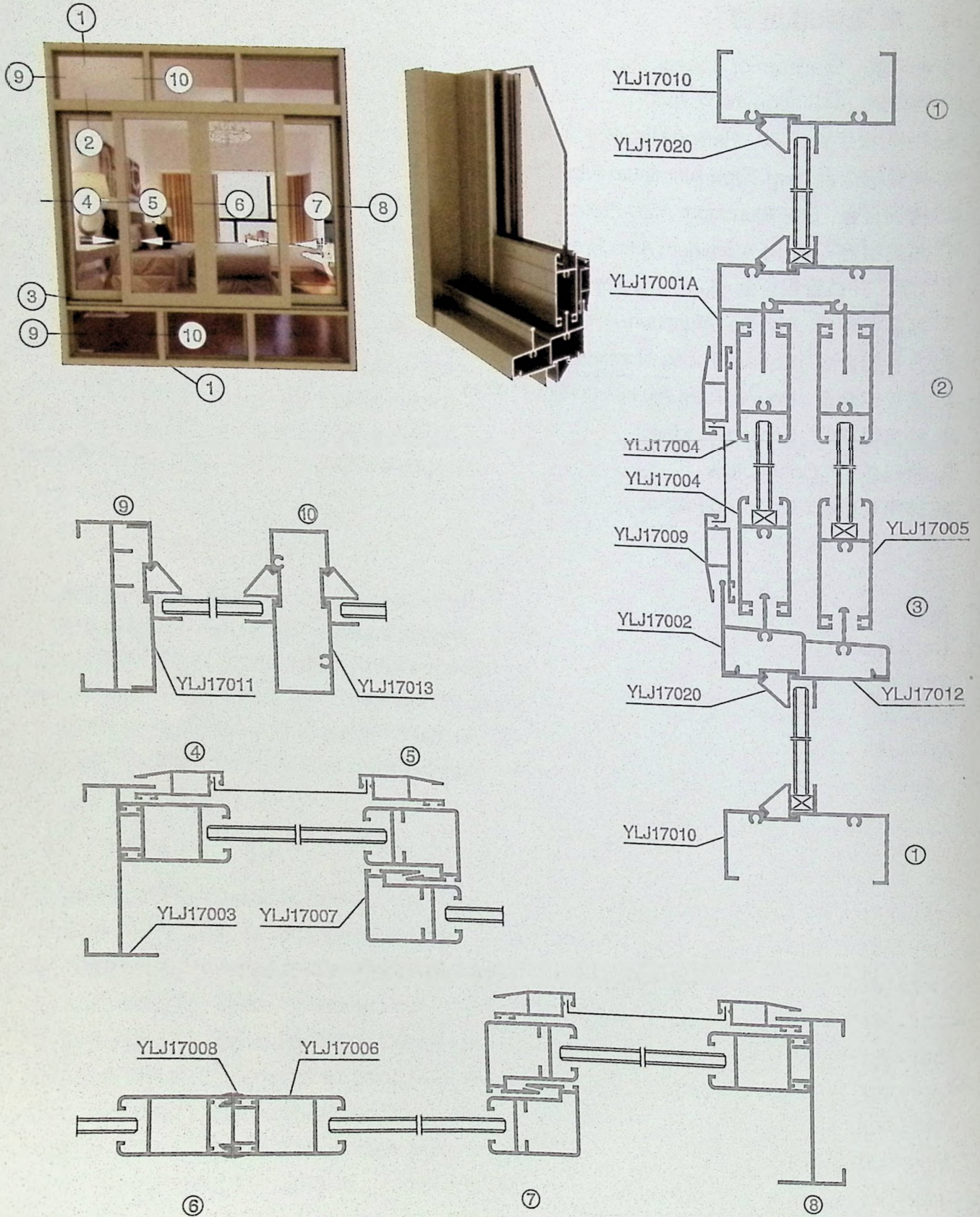

70系列推拉窗(中空)结构图
Structure Diagram of Series 70 Sliding Window(Hollow)

永利坚铝材 YONGLIJIAN

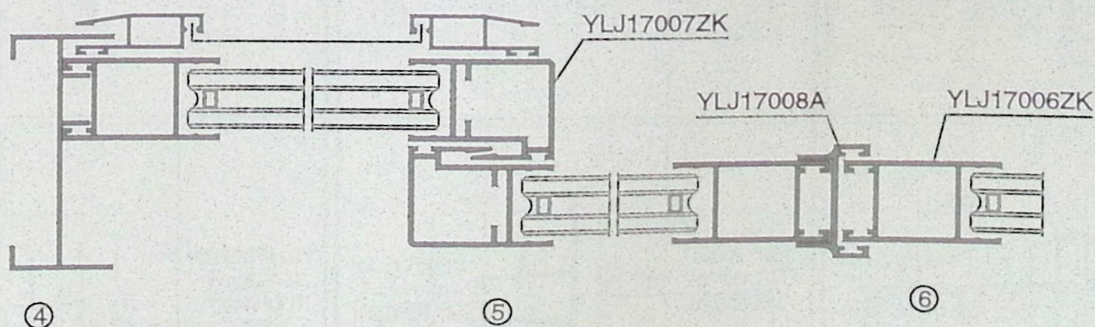
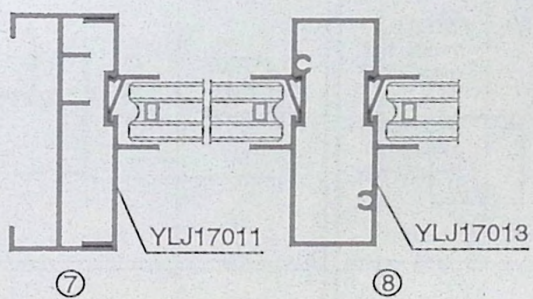
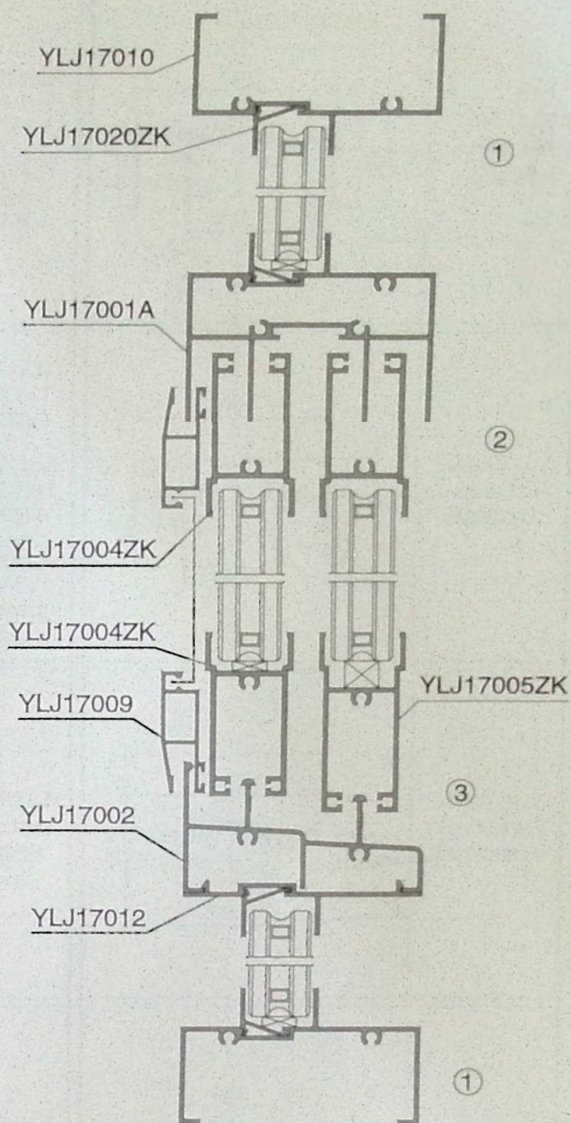
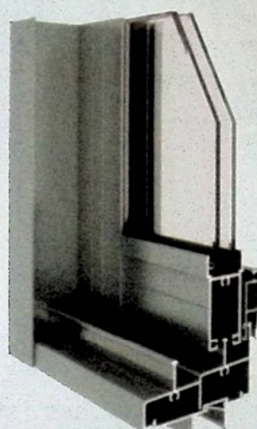
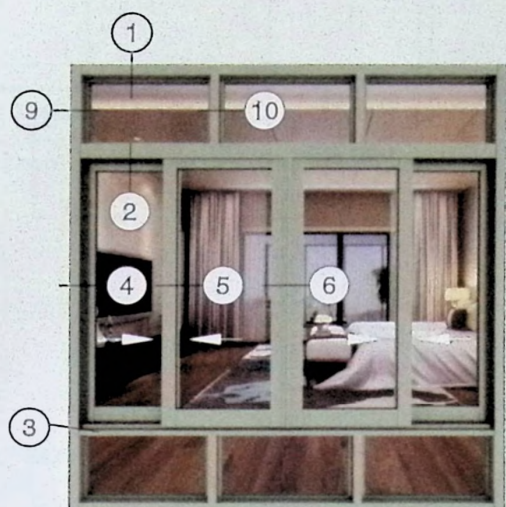

型号厚度 米重/kgm	产品图例	型号厚度 米重/kgm	产品图例	型号厚度 米重/kgm	产品图例
YLJ17001 T=1.20mm 0.733kg/m		YLJ17001AT T=1.40mm 1.247kg/m YLJ17001A T=1.20mm 1.181kg/m		YLJ17001B T=1.20mm 0.956kg/m	
YLJ17001DP* T=(1.20mm) 0.932kg/m		YLJ17001E T=1.20mm 0.928kg/m YLJ17001EP* T=(1.20mm) 0.965kg/m YLJ17001ET T=1.40mm 1.144kg/m		YLJ17001P* T=(1.20mm) 0.733kg/m YLJ17001T T=1.40mm 0.830kg/m	
YLJ17001SP* T=(1.20mm) 0.933kg/m		YLJ17001CP* T=(1.20mm) 1.292kg/m		YLJ17002 T=1.20mm 0.670kg/m	
YLJ17002AQ T=1.20mm 0.873kg/m		YLJ17002AT T=1.40mm 0.749kg/m		YLJ17002B T=1.20mm 0.731kg/m	
YLJ17002C T=1.20mm 0.659kg/m YLJ17002CP* T=(1.20mm) 0.630kg/m		YLJ17002D T=1.20mm 0.891kg/m		YLJ17002DA T=1.20mm 0.869kg/m	

注：图中所示为标注厚度的理论重量，以过磅时的重量为准。

70系列推拉窗型材图

Aluminium Profiles for Series 70 Sliding Window

永利坚铝材 YONGLIJIAN



型号厚度 米重/kgm	产品图例	型号厚度 米重/kgm	产品图例	型号厚度 米重/kgm	产品图例
YLJ17002E T=1.20mm 0.718kg/m		YLJ17002F* T=(1.20mm) 0.980kg/m YLJ17002FP* T=(1.20mm) 0.970kg/m		YLJ17002G T=1.20mm 0.740kg/m	
YLJ17002M T=1.20mm 0.552kg/m		YLJ17002T T=1.40mm 0.752kg/m		YLJ17002P* T=(1.20mm) 0.670kg/m	
YLJ17002GT T=1.40mm 0.814kg/m		YLJ17002H T=1.20mm 0.696kg/m YLJ17002HP* T=1.20mm 0.653kg/m		YLJ17002V T=1.20mm 0.781kg/m	
YLJ17002U T=(1.20mm) 0.764kg/m		YLJ17022 T=1.20mm 0.869kg/m		YLJ17022B T=1.20mm 0.992kg/m	
YLJ17003 T=1.20mm 0.518kg/m YLJ17003P* T=1.20mm 0.518kg/m YLJ17003T T=1.40mm 0.602kg/m		YLJ17003A T=1.20mm 0.610kg/m		YLJ17003AT T=1.40mm 1.006kg/m	

注：图中所示为标注厚度的理论重量，实际重量以过磅时的重量为准。



型号厚度 米重/kgm	产品图例	型号厚度 米重/kgm	产品图例	型号厚度 米重/kgm	产品图例	
YLJ17003B T=1.20mm 0.801kg/m		YLJ17003D* T=1.20mm 0.791kg/m		YLJ17003E* T=(1.20mm) 0.782kg/m		
YLJ17003TA T=1.20mm 0.420kg/m		YLJ17003SP* T=(1.20mm) 0.489kg/m		YLJ17004 T=1.20mm 0.514kg/m		
YLJ17004C* T=(1.20mm) 0.477kg/m		YLJ17004P* T=(1.20mm) 0.516kg/m		YLJ17004TZK T=1.40mm 0.562kg/m		
YLJ17005 T=1.20mm 0.648kg/m		YLJ17005A T=1.20mm 0.649kg/m		YLJ17005AZK T=1.20mm 0.628kg/m		
YLJ17005P* T=(1.20mm) 0.648kg/m		YLJ17005T T=1.40mm 0.612kg/m	YLJ17005ZK T=1.20mm 0.596kg/m		YLJ17005TZK T=1.40mm 0.599kg/m	
YLJ17005C T=1.20mm 0.609kg/m						

注：图中所示为标注厚度的理论重量，实际重量以过磅时的重量为准。

70系列推拉窗型材图

Aluminium Profiles for Series 70 Sliding Window

永利坚铝材 YONGLIJIAN



型号厚度 米重/kgm	产品图例	型号厚度 米重/kgm	产品图例	型号厚度 米重/kgm	产品图例
YLJ17006 T=1.20mm 0.517kg/m YLJ17006P* T=(1.20mm) 0.498kg/m		YLJ17006C T=1.20mm 0.558kg/m YLJ17006CP* T=(1.20mm) 0.539kg/m		YLJ17006CT T=1.40mm 0.702kg/m	
YLJ17006T T=1.40mm 0.592kg/m		YLJ17006TZK T=1.40mm 0.561kg/m YLJ17006ZK T=1.20mm 0.482kg/m		YLJ17006D* T=(1.20mm) 0.524kg/m	
YLJ17007 T=1.20mm 0.570kg/m YLJ17007P* T=(1.20mm) 0.479kg/m		YLJ17007T T=1.40mm 0.637kg/m		YLJ17007C T=1.20mm 0.580kg/m	
YLJ17007CP* T=(1.20mm) 0.564kg/m		YLJ17007CZK T=1.20mm 0.539kg/m		YLJ17007D* T=(1.20mm) 0.524kg/m	
YLJ17007PA T=1.20mm 0.455kg/m		YLJ17007TZK T=1.40mm 0.633kg/m YLJ17007ZK T=1.20mm 0.554kg/m		YLJ17007SP* T=(1.20mm) 0.532kg/m	

注：图中所示为标注厚度的理论重量，实际重量以过磅时的重量为准。



型号厚度 米重/kgm	产品图例	型号厚度 米重/kgm	产品图例	型号厚度 米重/kgm	产品图例
YLJ17016P* T=(1.20mm) 0.956kg/m YLJ17016 T=1.20mm 0.985kg/m		YLJ17016A T=(1.20mm) 0.942kg/m		YLJ17016B T=(1.20mm) 0.885kg/m	
YLJ17026P* T=(1.20mm) 0.627kg/m		YLJ17027P* T=(1.20mm) 0.654kg/m		YLJ17031 T=(1.20mm) 0.704kg/m	
YLJ17023 T=1.20mm 0.698kg/m YLJ17023P* T=(1.20mm) 0.669kg/m YLJ17023S T=1.60mm 0.918kg/m		YLJ17008 T=1.00mm 0.199kg/m		YLJ17008C T=1.00mm 0.141kg/m	
YLJ17009B T=0.80mm 0.247kg/m		YLJ17008A T=1.20mm 0.343kg/m		YLJ17009 T=0.80mm 0.233kg/m	
YLJ17009C T=0.80mm 0.245kg/m		YLJ17011AP T=1.00mm 0.288kg/m		YLJ17012 T=1.20mm 0.320kg/m	
YLJ17012AP T=1.00mm 0.243kg/m		YLJ17011APP T=0.80mm 0.239kg/m		YLJ17012P T=1.00mm 0.286kg/m	
YLJ17011 T=1.20mm 0.365kg/m YLJ17011P T=1.00mm 0.315kg/m		YLJ17011 T=1.20mm 0.365kg/m YLJ17011P T=1.00mm 0.315kg/m		YLJ17010T T=1.40mm 0.637kg/m YLJ17010 T=1.20mm 0.572kg/m	

注：图中所示为标注厚度的理论重量，实际重量以过磅时的重量为准。

70系列推拉窗型材图

Aluminium Profiles for Series 70 Sliding Window

永利坚铝材 YONGLIJIAN



型号厚度 米重/kgm	产品图例	型号厚度 米重/kgm	产品图例	型号厚度 米重/kgm	产品图例
YLJ17010B T=1.20mm 0.832kg/m		YLJ17010PA T=1.20mm 0.513kg/m		YLJ17010AP* T=(1.20mm) 0.519kg/m YLJ17010A T=1.20mm 0.536kg/m YLJ17010AT T=1.40mm 0.602kg/m	
YLJ17013 T=1.20mm 0.797kg/m YLJ17013T T=1.40mm 0.899kg/m YLJ17013P* T=(1.20mm) 0.797kg/m		YLJ17013AP* T=(1.20mm) 0.719kg/m		YLJ17013B T=1.20mm 0.922kg/m	
YLJ17013DP* T=(1.20)mm 0.718kg/m		YLJ17017 T=1.20mm 0.754kg/m		YLJ17018 T=1.20mm 0.903kg/m	
YLJ17018A T=1.20mm 0.906kg/m		YLJ17018B T=1.20mm 1.033kg/m		YLJ17028 T=1.40mm 1.120kg/m	
YLJ17003C T=1.20mm 1.149kg/m		YLJ17019 T=0.80mm 0.091kg/m		YLJ17020ZK T=0.80mm 0.073kg/m	
		YLJ17020 T=0.80mm 0.085kg/m			

注：图中所示为标注厚度的理论重量，实际重量以过磅时的重量为准。

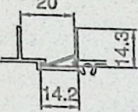
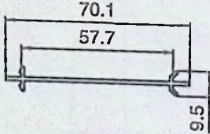
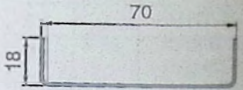

型号厚度 米重/kgm	产品图例	型号厚度 米重/kgm	产品图例	型号厚度 米重/kgm	产品图例
YLJ17020ZKPT T=0.80mm 0.072kg/m		YLJ17014 T=1.50mm 0.347kg/m		YLJ17015 T=1.00mm 0.277kg/m	

注：图中所示为标注厚度的理论重量，实际重量以过磅时的重量为准。

80B系列推拉窗结构图

Structure Diagram of Series 80B Sliding Window

永利坚铝材 YONGLIJIAN

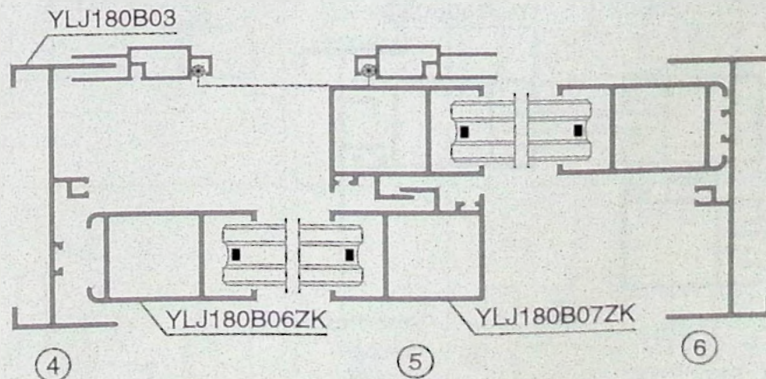
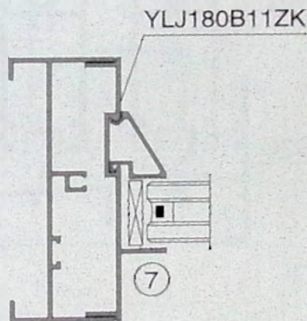
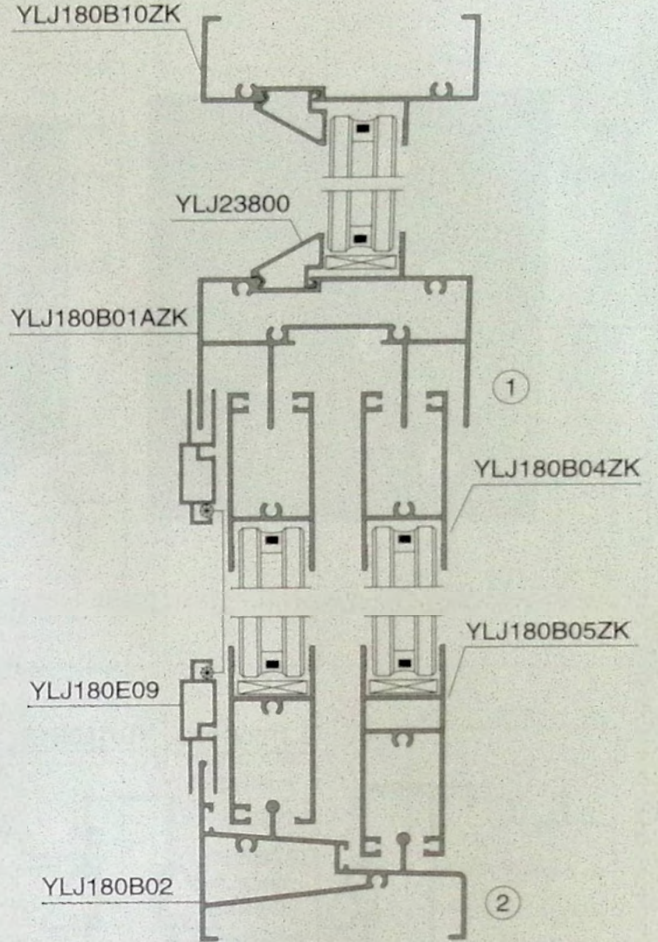
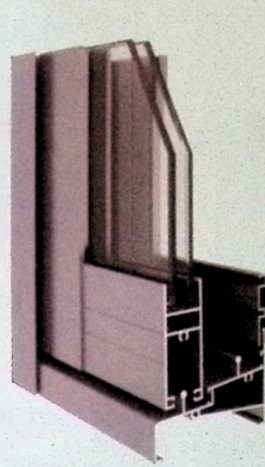
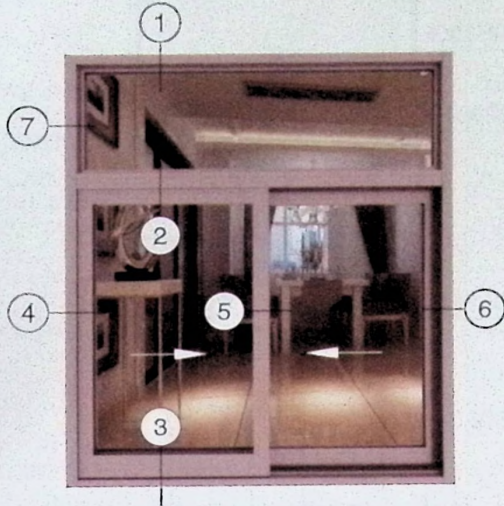

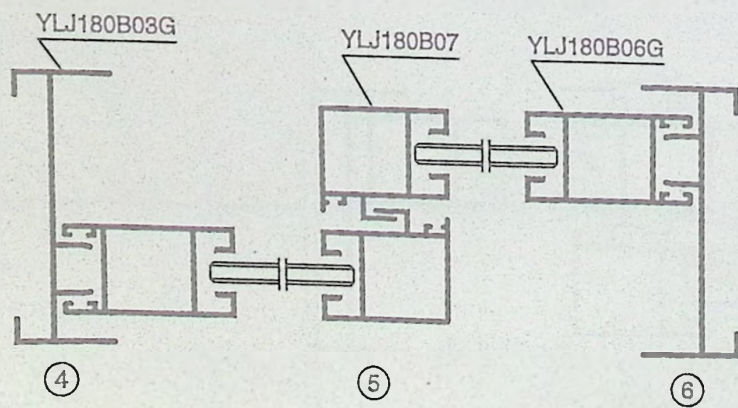
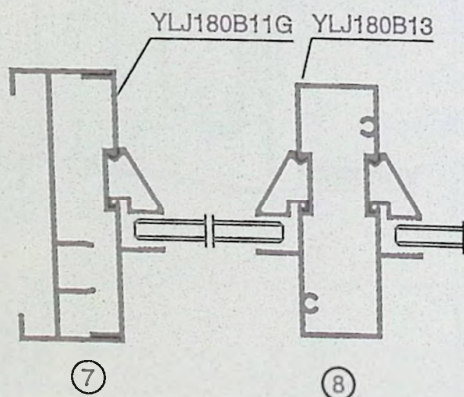
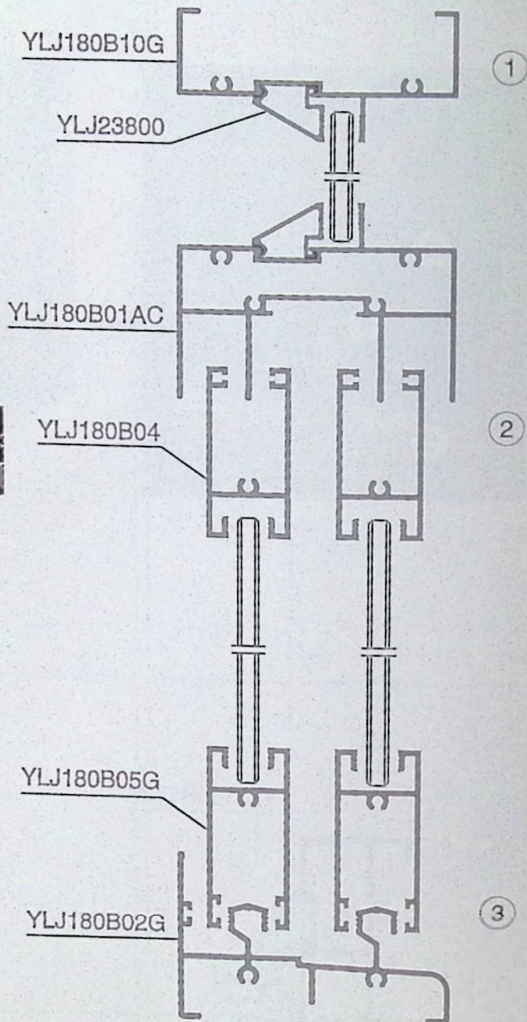
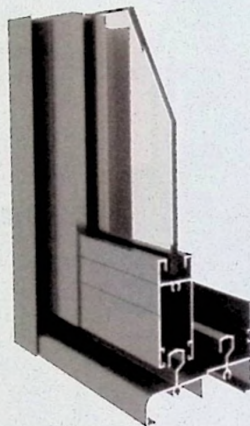
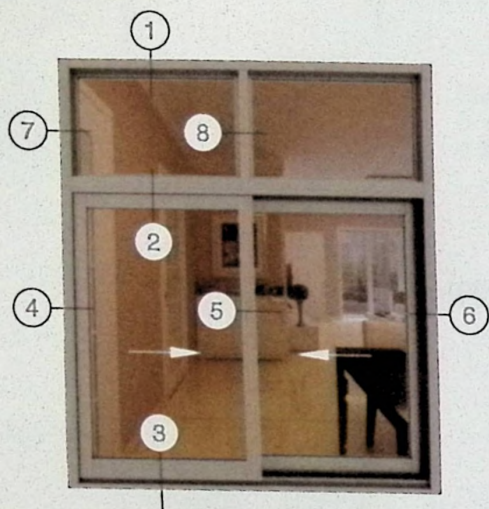

80B系列推拉窗型材图

Aluminium Profiles for Series 80B Sliding Window

永利坚铝材 YONGLIJIAN



型号厚度 米重/kgm	产品图例	型号厚度 米重/kgm	产品图例	型号厚度 米重/kgm	产品图例
YLJ180B01 T=1.20mm 0.746kg/m YLJ180B01T T=1.40mm 0.856kg/m		YLJ180B01A T=1.20mm 1.163kg/m YLJ180B01AT T=1.40mm 1.329kg/m		YLJ180B01ATZK T=1.40mm 1.292kg/m YLJ180B01AZK T=1.20mm 1.165kg/m	
YLJ180B01AC T=1.20mm 1.186kg/m		YLJ180B01BZK T=1.20mm 1.256kg/m		YLJ180B01C T=1.20mm 0.766kg/m	
YLJ180B01W T=1.20mm 0.828kg/m		YLJ180B02 T=1.20mm 0.890kg/m YLJ180B02T T=1.40mm 0.993kg/m		YLJ180B02A T=1.20mm 1.101kg/m YLJ180B02AT T=1.40mm 1.198kg/m	
YLJ180B02ATZK T=1.40mm 1.177kg/m YLJ180B02AZK T=1.20mm 1.093kg/m		YLJ180B02B T=1.20mm 1.004kg/m		YLJ180B02DTZK T=1.40mm 1.409kg/m	
YLJ180B02E T=1.20mm 1.064kg/m YLJ180B02ET T=1.40mm 1.196kg/m		YLJ180B02F T=1.2mm 1.050kg/m		YLJ180B02G T=1.25mm 0.915kg/m	

注：图中所示为标注厚度的理论重量，实际重量以过磅时的重量为准。



型号厚度 米重/kgm	产品图例	型号厚度 米重/kgm	产品图例	型号厚度 米重/kgm	产品图例
YLJ180B02GP* T=(1.2)mm 0.891kg/m		YLJ180B02N T=1.40mm 0.853kg/m		YLJ180B02W T=1.20mm 0.944kg/m	
YLJ180B02WA T=1.2mm 1.162kg/m		YLJ180B02Z T=1.35mm 0.771kg/m		YLJ180B27 T=1.80mm 0.977kg/m	
YLJ180B03 T=1.20mm 0.561kg/m YLJ180B03T T=1.40mm 0.643kg/m		YLJ180B03A T=1.20mm 1.056kg/m		YLJ180B03D T=1.35mm 1.076kg/m	
YLJ180B03G T=1.25mm 0.592kg/m		YLJ180B03Z T=1.35mm 0.613kg/m		YLJ180B26 T=1.80mm 0.797kg/m	
YLJ180B04 T=1.20mm 0.562kg/m		YLJ180B04KZK T=1.40mm 0.591kg/m		YLJ180B04T T=1.40mm 0.628kg/m	

80B系列推拉窗型材图

Aluminium Profiles for Series 80B Sliding Window

永利坚铝材 YONGLIJIAN



型号厚度 米重/kgm	产品图例	型号厚度 米重/kgm	产品图例	型号厚度 米重/kgm	产品图例
YLJ180B04ZK T=1.20mm 0.521kg/m		YLJ180B04TZK T=1.40mm 0.592kg/m		YLJ180B05 T=1.20mm 0.698kg/m	
YLJ180B05AZK T=1.20mm 0.528kg/m		YLJ180B05BZK T=1.20mm 0.664kg/m		YLJ180B05B T=1.20mm 0.719kg/m	
YLJ180B05G T=1.25mm 0.583kg/m		YLJ180B05KZK T=1.40mm 0.747kg/m		YLJ180B05T T=1.40mm 0.785kg/m	
YLJ180B05TZK T=1.40mm 0.746kg/m		YLJ180B05ZK T=1.20mm 0.658kg/m		YLJ180B06 T=1.20mm 0.548kg/m	
YLJ180B06ATZK T=1.40mm 0.736kg/m		YLJ180B06G T=1.25mm 0.642kg/m		YLJ180B06KAZK T=1.40mm 0.653kg/m	

注：图中所示为标注厚度的理论重量，实际重量以过磅时的重量为准。

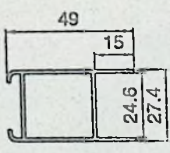
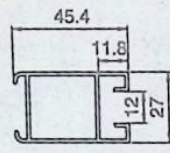
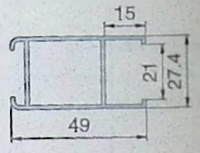
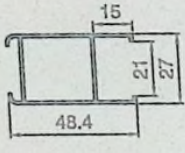
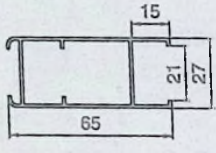
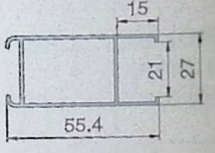
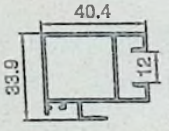
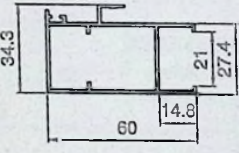
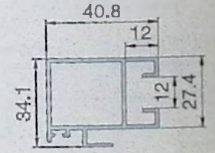
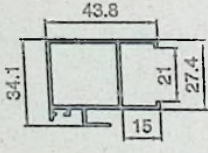
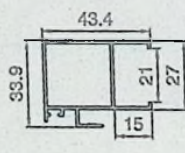
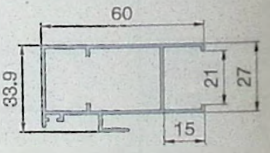
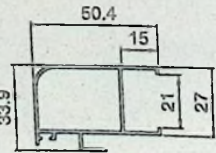
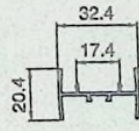
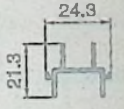
型号厚度 米重/kgm	产品图例	型号厚度 米重/kgm	产品图例	型号厚度 米重/kgm	产品图例
YLJ180B06KZK T=1.40mm 0.573kg/m		YLJ180B06T T=1.40mm 0.632kg/m		YLJ180B06TZK T=1.40mm 0.593kg/m	
YLJ180B06ZK T=1.20mm 0.504kg/m		YLJ180B06ZKA T=1.20mm 0.625kg/m		YLJ180B06ZKB T=1.20mm 0.550kg/m	
YLJ180B07 T=1.20mm 0.585kg/m		YLJ180B07ATZK T=1.40mm 0.772kg/m		YLJ180B07T T=1.40mm 0.665kg/m	
YLJ180B07TZK T=1.40mm 0.624kg/m		YLJ180B07ZK T=1.20mm 0.540kg/m		YLJ180B07ZKA T=1.20mm 0.670kg/m	
YLJ180B07ZKB T=1.20mm 0.575kg/m		YLJ180B08 T=1.20mm 0.271kg/m		YLJ180B08A T=1.40mm 0.238kg/m	

80B系列推拉窗型材图

Aluminium Profiles for Series 80B Sliding Window

永利坚铝材 YONGLIJIAN



型号厚度 米重/kgm	产品图例	型号厚度 米重/kgm	产品图例	型号厚度 米重/kgm	产品图例
YLJ180B10 T=1.20mm 0.564kg/m		YLJ180B10A T=1.20mm 0.783kg/m YLJ180B10AT T=1.40mm 0.883kg/m		YLJ180B10G T=1.20mm 0.585kg/m	
YLJ180B10P* T=(1.20)mm 0.548kg/m		YLJ180B10T T=1.40mm 0.636kg/m		YLJ180B10ZK T=1.20mm 0.564kg/m YLJ180B10TZK T=1.40mm 0.628kg/m	
YLJ180B11 T=1.20mm 0.398kg/m YLJ180B11P T=1.00mm 0.339kg/m		YLJ180B11G T=1.20mm 0.404kg/m		YLJ180B11ZK T=1.20mm 0.398kg/m YLJ180B11TZK T=1.40mm 0.447kg/m	
YLJ180B12 T=1.20mm 0.363kg/m		YLJ180B12B T=1.20mm 0.372kg/m		YLJ180B12ZK T=1.20mm 0.363kg/m	
YLJ180B13 T=1.20mm 0.857kg/m YLJ180B13T T=1.40mm 0.963kg/m		YLJ180B13TZK T=1.40mm 0.961kg/m YLJ180B13ZK T=1.20mm 0.859kg/m		YLJ180B14 T=1.20mm 0.333kg/m	

注：图中所示为标注厚度的理论重量，实际重量以过磅时的重量为准。



型号厚度 米重/kgm	产品图例	型号厚度 米重/kgm	产品图例	型号厚度 米重/kgm	产品图例
YLJ180B14A T=1.20mm 0.746kg/m		YLJ180B17 T=1.20mm 0.860kg/m		YLJ180B18 T=1.20mm 0.984kg/m	
YLJ180B19 T=0.80mm 0.178kg/m		YLJ180B19ZK T=0.90mm 0.144kg/m		YLJ180B20 T=0.80mm 0.160kg/m	
YLJ180B21A T=1.35mm 1.438kg/m		YLJ180B21ZK T=1.20mm 1.143kg/m		YLJ180B25 T=1.20mm 0.862kg/m	
YLJ180B26 T=1.80mm 0.797kg/m		YLJ180B27 T=1.80mm 0.977kg/m			

82系列推拉窗结构图
Structure Diagram of Series 82 Sliding Window

永利坚铝材 YONGLIJIAN

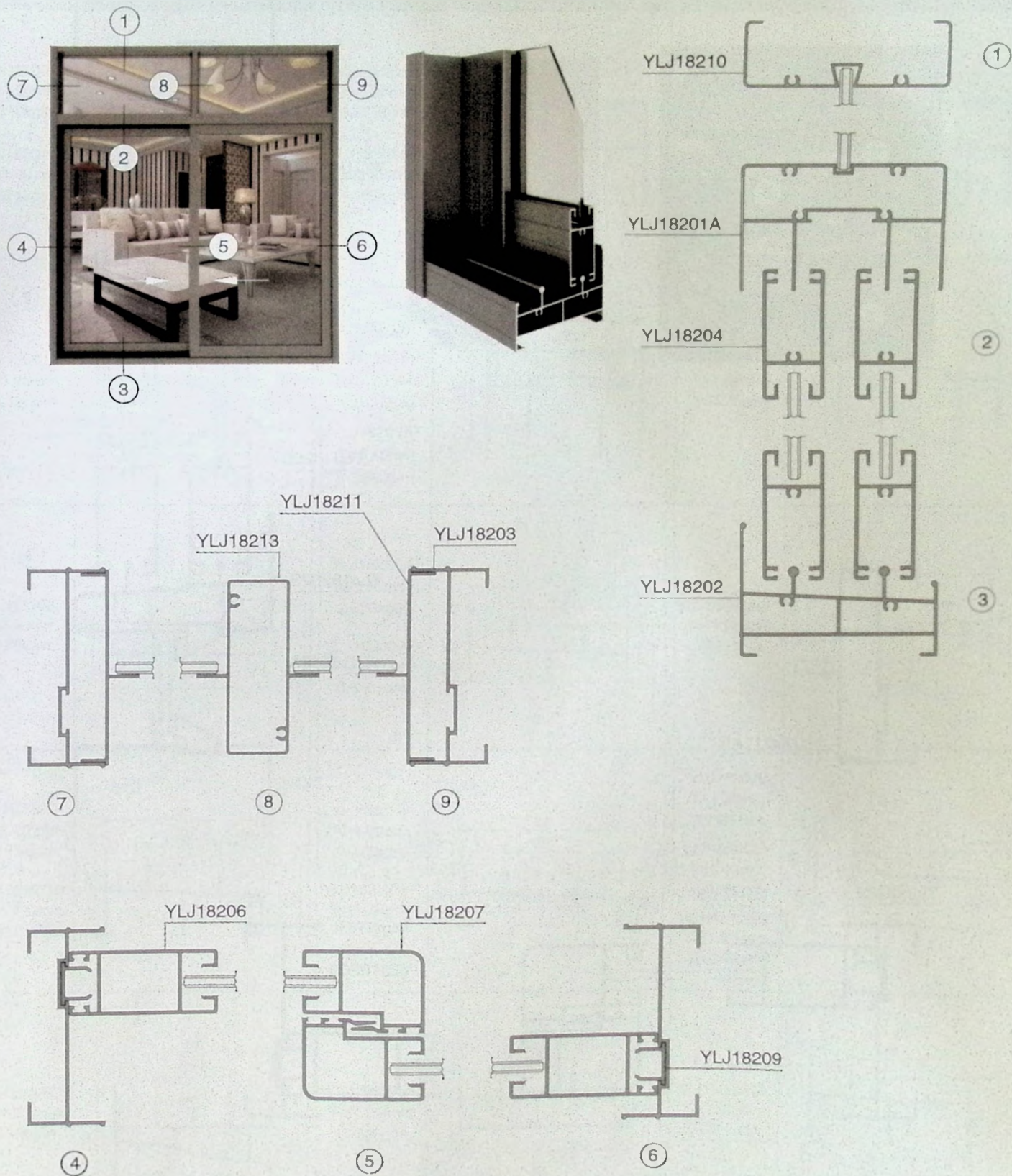

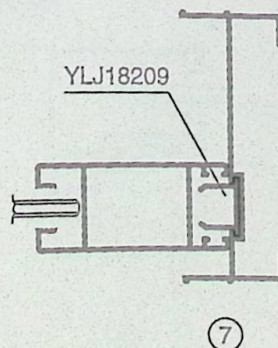
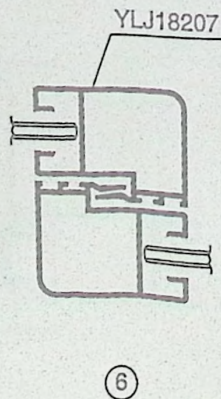
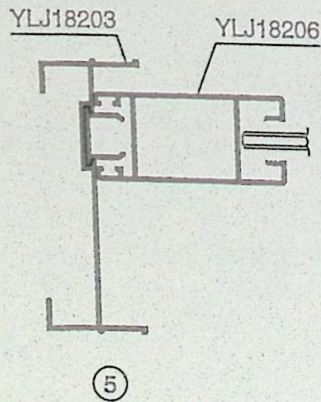
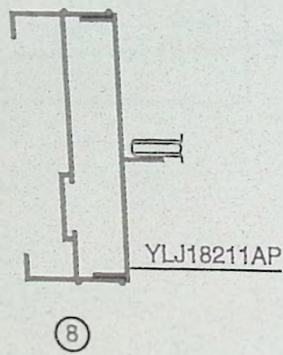
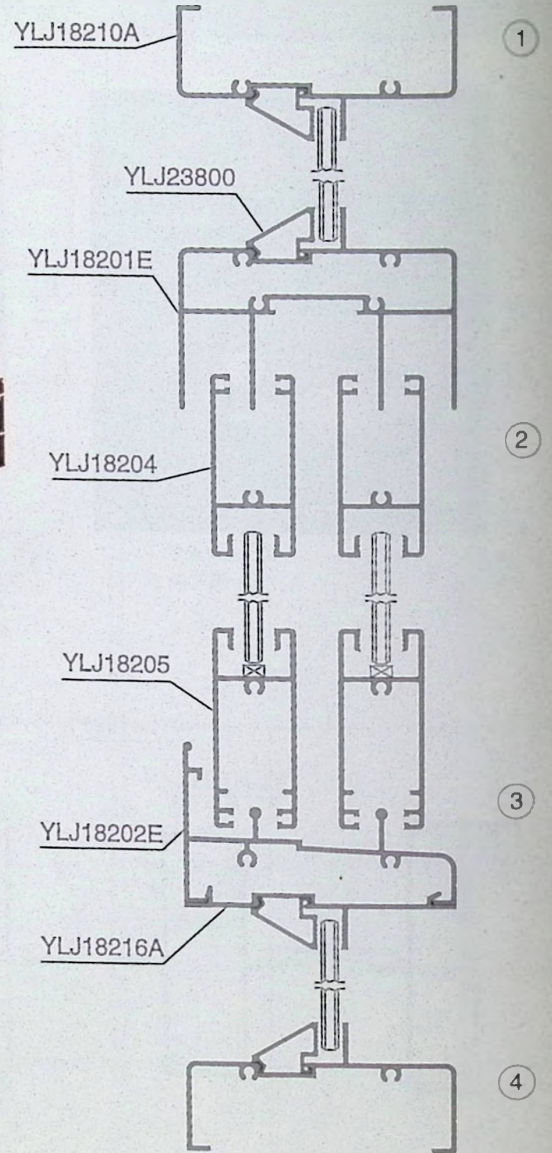
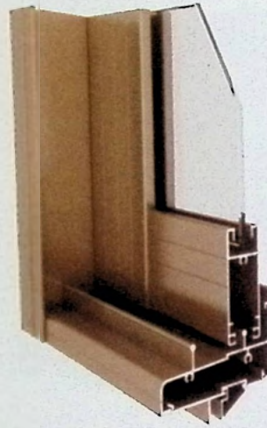
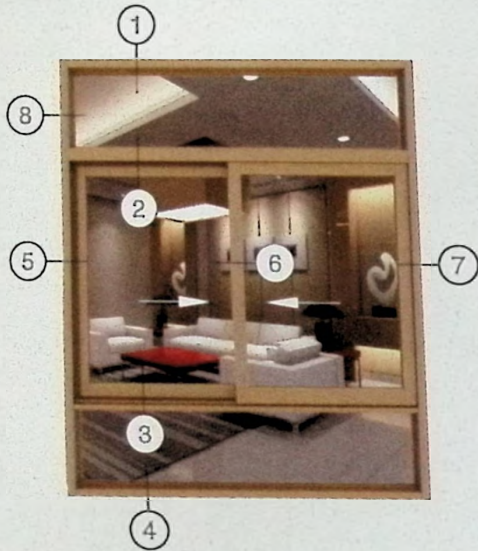

82系列推拉窗型材图

Aluminium Profiles for Series 82 Sliding Window

永利坚铝材 YONGLIJIAN



型号厚度 米重/kgm	产品图例	型号厚度 米重/kgm	产品图例	型号厚度 米重/kgm	产品图例
YLJ18201 T=1.20mm 0.910kg/m YLJ18201P* T=(1.20)mm 0.871kg/m		YLJ18201A T=1.20mm 1.225kg/m YLJ18201AP* T=(1.20)mm 1.189kg/m		YLJ18201AS T=1.60mm 1.628kg/m	
YLJ18201E T=1.20mm 1.232kg/m		YLJ18201F T=1.20mm 1.176kg/m YLJ18201FP* T=(1.20)mm 1.142kg/m YLJ18201FT T=1.40mm 1.355kg/m		YLJ18201S T=1.60mm 1.173kg/m	
YLJ18202 T=1.20mm 1.120kg/m		YLJ18202A* T=(1.20)mm 0.676kg/m YLJ18202AP* T=(1.20)mm 0.695kg/m		YLJ18202AJP* T=(1.20)mm 0.871kg/m	
YLJ18202C* T=(1.20)mm 0.795kg/m YLJ18202CP* T=(1.20)mm 0.817kg/m		YLJ18202D T=1.20mm 0.726kg/m YLJ18202DP* T=(1.20)mm 0.677kg/m		YLJ18202E T=1.20mm 0.719kg/m YLJ18202ET T=1.40mm 0.824kg/m YLJ18202EP* T=(1.20)mm 0.684kg/m	
YLJ18202K* T=(1.20)mm 1.144kg/m		YLJ18202M* T=(1.20)mm 1.051kg/m		YLJ18202NP* T=(1.20)mm 0.865kg/m	

注：图中所示为标注厚度的理论重量，实际重量以过磅时的重量为准。



型号厚度 米重/kgm	产品图例	型号厚度 米重/kgm	产品图例	型号厚度 米重/kgm	产品图例
YLJ18202Q* T=(1.20)mm 0.778kg/m YLJ18202QA T=1.20mm 0.809kg/m		YLJ18202S T=1.60mm 1.434kg/m		YLJ18202XA T=1.40mm 1.341kg/m	
YLJ18202XB T=1.20mm 0.861kg/m		YLJ18202XC T=1.40mm 0.968kg/m		YLJ18202XE T=1.40mm 1.262kg/m	
YLJ18202XF T=1.40mm 1.147kg/m		YLJ18202XG T=1.40mm 1.401kg/m		YLJ18202WB T=1.25mm 1.413kg/m	
YLJ18203 T=1.20mm 0.573kg/m YLJ18203S T=1.60mm 0.765kg/m		YLJ18203A* T=(1.20)mm 0.569kg/m YLJ18203AT T=1.40mm 0.712kg/m YLJ18203AP* T=(1.20)mm 0.585kg/m		YLJ18203DP* T=(1.20)mm 0.463kg/m	
YLJ18203F T=1.20mm 0.615kg/m YLJ18203FP* T=(1.20)mm 0.580kg/m		YLJ18203T T=1.40mm 0.669kg/m		YLJ18204* T=(1.20)mm 0.555kg/m	

82系列推拉窗型材图

Aluminium Profiles for Series 82 Sliding Window

永利坚铝材 YONGLIJIAN



型号厚度 米重/kgm	产品图例	型号厚度 米重/kgm	产品图例	型号厚度 米重/kgm	产品图例
YLJ18204A* T=(1.20)mm 0.552kg/m YLJ18204AP* T=(1.20)mm 0.562kg/m		YLJ18204S T=1.60mm 0.767kg/m		YLJ18204T T=1.40mm 0.689kg/m	
YLJ18204TZK T=1.40mm 0.630kg/m		YLJ18205 T=1.20mm 0.654kg/m		YLJ18205A* T=(1.20)mm 0.567kg/m	
YLJ18205E T=1.20mm 0.759kg/m		YLJ18205Y T=1.60mm 0.925kg/m		YLJ18206 T=1.20mm 0.688kg/m	
YLJ18206A* T=(1.20)mm 0.634kg/m YLJ18206AP* T=(1.20)mm 0.661kg/m YLJ18206D T=1.20mm 0.681kg/m		YLJ18206S T=1.60mm 0.898kg/m		YLJ18206T T=1.40mm 0.797kg/m	
YLJ18206TZK T=1.40mm 0.754kg/m		YLJ18207 T=1.20mm 0.672kg/m		YLJ18207A* T=(1.20)mm 0.628kg/m YLJ18207AP* T=(1.20)mm 0.646kg/m YLJ18207D T=1.20mm 0.675kg/m	

注：图中所示为标注厚度的理论重量，实际重量以过磅时的重量为准。



型号厚度 米重/kgm	产品图例	型号厚度 米重/kgm	产品图例	型号厚度 米重/kgm	产品图例
YLJ18207BD T=1.20mm 0.650kg/m		YLJ18207T T=1.40mm 0.766kg/m		YLJ18207TZK T=1.40mm 0.724kg/m	
YLJ18207S T=1.60mm 0.869kg/m		YLJ18208 T=1.00mm 0.284kg/m		YLJ18209 T=0.80mm 0.093kg/m	
YLJ18209PT T=0.80mm 0.094kg/m		YLJ18209P T=1.00mm 0.114kg/m		YLJ18209S T=1.60mm 0.180kg/m	
YLJ18210 T=1.20mm 0.607kg/m		YLJ18210A T=1.20mm 0.601kg/m		YLJ18210S T=1.60mm 0.800kg/m	
YLJ18210P* T=(1.20)mm 0.582kg/m					
YLJ18211 T=1.10mm 0.359kg/m		YLJ18211AP T=1.00mm 0.365kg/m		YLJ18211Q T=0.80mm 0.246kg/m	
YLJ18211P T=1.00mm 0.325kg/m					

82系列推拉窗型材图

Aluminium Profiles for Series 82 Sliding Window

永利坚铝材 YONGLIJIAN



型号厚度 米重/kgm	产品图例	型号厚度 米重/kgm	产品图例	型号厚度 米重/kgm	产品图例
YLJ18211S T=1.60mm 0.507kg/m		YLJ18211T T=1.40mm 0.444kg/m		YLJ18212 T=1.10mm 0.310kg/m	
YLJ18212A T=1.10mm 0.354kg/m		YLJ18213P* T=(1.20)mm 0.757kg/m		YLJ18213S T=1.60mm 1.038kg/m	
YLJ18214 T=1.10mm 0.405kg/m		YLJ18215* T=(1.20)mm 0.955kg/m		YLJ18215H T=2.00mm 1.713kg/m	
YLJ18215T T=1.40mm 1.207kg/m		YLJ18216 T=1.10mm 0.312kg/m			
YLJ18216A T=1.10mm 0.362kg/m		YLJ18218JP T=0.80mm 0.246kg/m		YLJ18219SP T=0.80mm 0.208kg/m	
YLJ18219JP T=0.80mm 0.199kg/m		YLJ18220T T=1.40mm 1.277kg/m		YLJ18221* T=(1.20)mm 0.212kg/m	
YLJ18220 T=1.20mm 1.356kg/m					

注：图中所示为标注厚度的理论重量，实际重量以过磅时的重量为准。

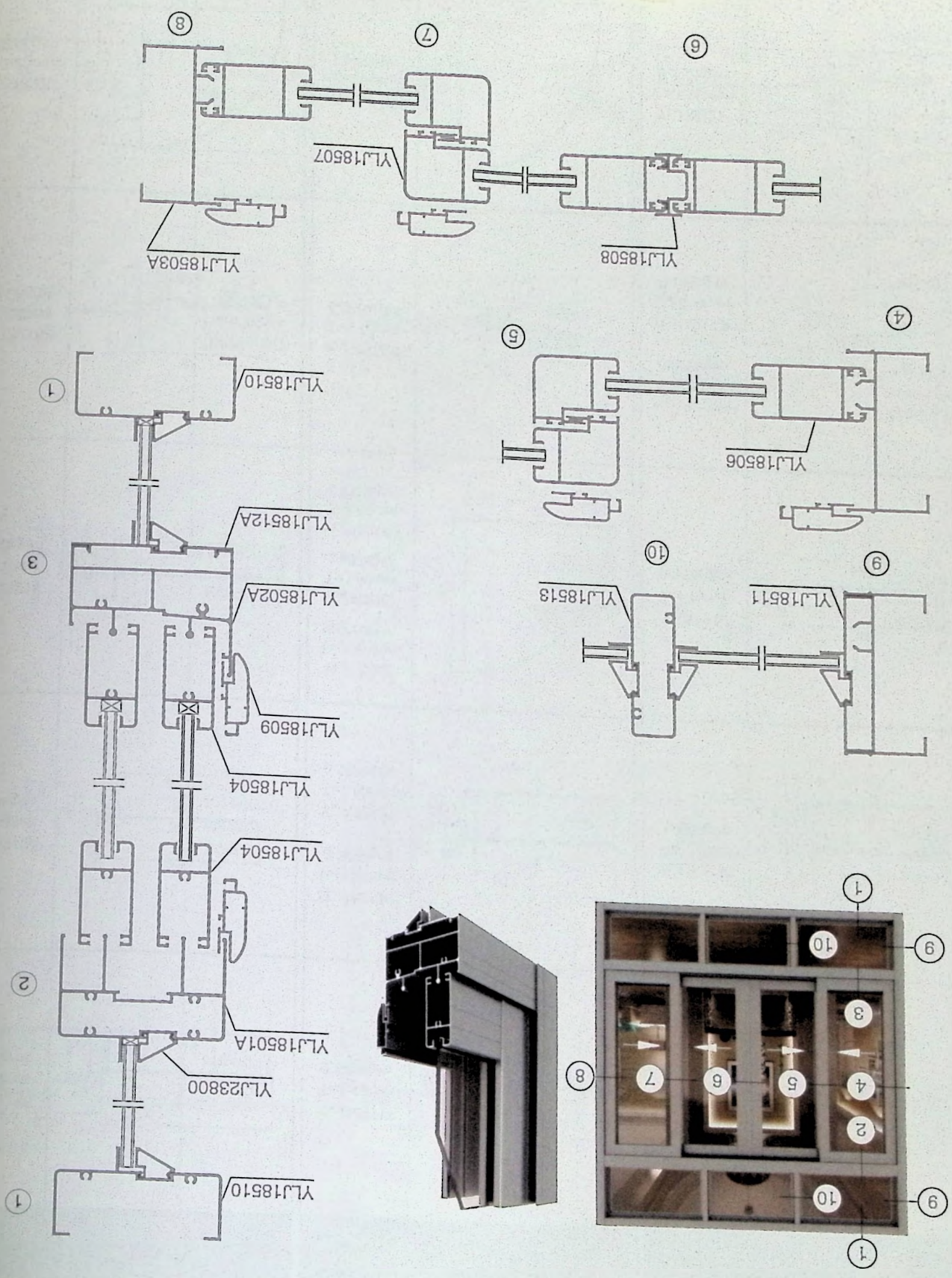

85系列推拉窗(单玻)结构图(新90系列)
Structure Diagram of Series 85 Sliding Window(Single)(new 90 series)

永利坚铝材 YONGLIJIAN



85系列推拉窗(中空)结构图(新90系列)

Structure Diagram of Series 85 Sliding Window(Hollow)(new 90 series)

永利坚铝材 YONGLIJIAN

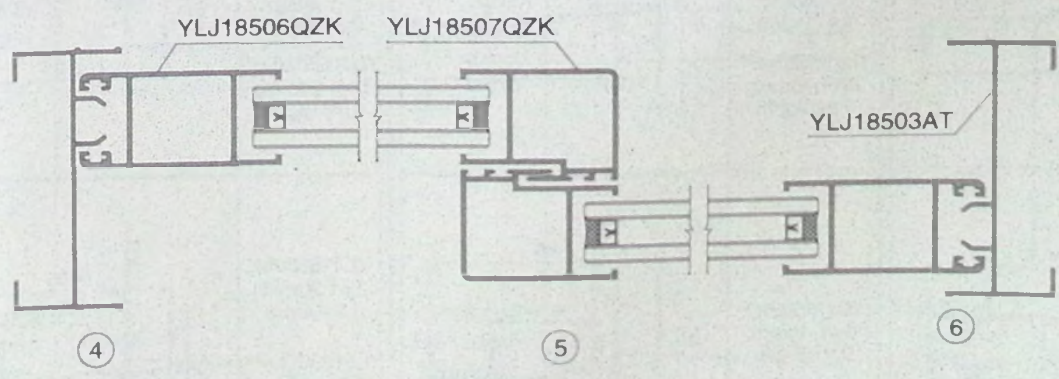
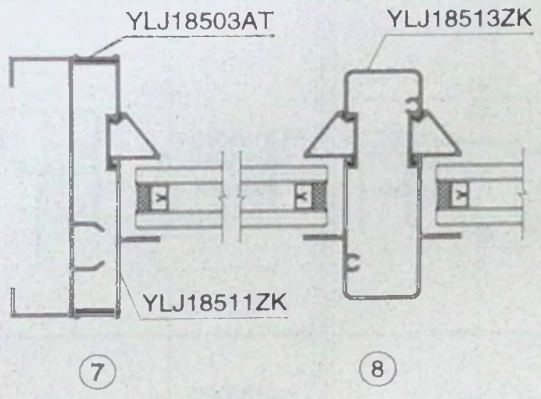
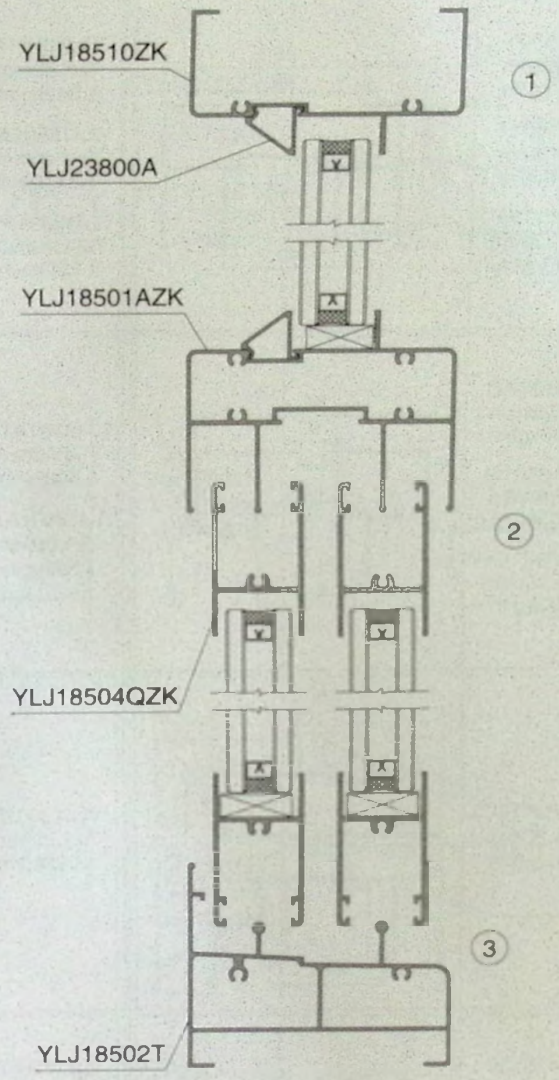
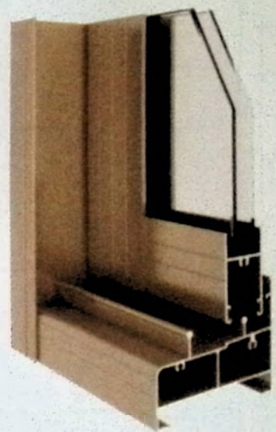
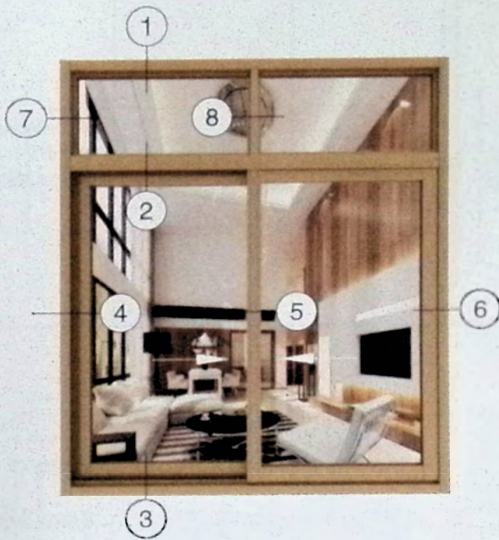



型号厚度 米重/kgm	产品图例	型号厚度 米重/kgm	产品图例	型号厚度 米重/kgm	产品图例
YLJ18501 T=1.20mm 0.977kg/m YLJ18501T T=1.40mm 1.114kg/m YLJ18501P* T=(1.20mm) 0.905kg/m		YLJ18501A T=1.20mm 1.349kg/m YLJ18501AT T=1.40mm 1.511kg/m YLJ18501AP* T=(1.20mm) 1.290kg/m		YLJ18501C T=1.20mm 0.884kg/m YLJ18501CT T=1.40mm 0.999kg/m	
YLJ18501D T=1.20mm 1.239kg/m YLJ18501G T=1.40mm 1.403kg/m YLJ18501DP* T=(1.20mm) 1.193kg/m		YLJ18501ATZK T=1.40mm 1.502kg/m YLJ18501AZK T=1.20mm 1.337kg/m		YLJ18501FA T=1.20mm 1.563kg/m	
YLJ18501FCX T=1.30mm 2.315kg/m		YLJ18501F T=1.20mm 1.099kg/m		YLJ18501B T=1.20mm 1.208kg/m	
YLJ18502 T=1.20mm 1.247kg/m YLJ18502T T=1.40mm 1.414kg/m YLJ18502P* T=(1.20mm) 1.162kg/m		YLJ18502A T=1.20mm 1.289kg/m YLJ18502AT T=1.40mm 1.471kg/m YLJ18502AP* T=(1.20mm) 1.220kg/m		YLJ18502C T=1.20mm 0.796kg/m YLJ18502CT T=1.40mm 0.899kg/m YLJ18502CP* T=(1.20mm) 0.781kg/m	
YLJ18502B T=1.20mm 1.323kg/m YLJ18502BT T=1.40mm 1.470kg/m		YLJ18502KT T=1.40mm 0.918kg/m		YLJ18502M T=1.20mm 0.710kg/m YLJ18502MP* T=(1.20mm) 0.702kg/m	

注：图中所示为标注厚度的理论重量，实际重量以过磅时的重量为准。

85系列推拉窗型材图(新90系列)

Aluminium Profiles for Series 85 Sliding Window(new 90 series)

永利坚铝材 YONGLIJIAN



型号厚度 米重/kgm	产品图例	型号厚度 米重/kgm	产品图例	型号厚度 米重/kgm	产品图例
YLJ18502E T=1.20mm 1.120kg/m		YLJ18502K* T=(1.20mm) 0.797kg/m		YLJ18502BZK T=1.20mm 1.327kg/m YLJ18502BTZK T=1.40mm 1.479kg/m	
YLJ18502D T=1.20mm 1.196kg/m YLJ18502DP* T=(1.20mm) 1.126kg/m		YLJ18502S T=1.20mm 1.370kg/m YLJ18502SP* T=(1.20mm) 1.343kg/m		YLJ18502N* T=(1.20mm) 0.894kg/m	
YLJ18502BA T=1.40mm 1.461kg/m		YLJ18502CB T=1.26mm 0.898kg/m		YLJ18502F T=1.20mm 0.867kg/m YLJ18502FT T=1.40mm 0.978kg/m	
YLJ18502FAT T=1.40mm 1.016kg/m		YLJ18502G T=1.20mm 1.404kg/m YLJ18502GT T=1.40mm 1.573kg/m		YLJ18502MA T=1.40mm 0.826kg/m	
YLJ18502XP* T=(1.20mm) 1.188kg/m		YLJ18502VP* T=(1.20mm) 1.409kg/m		YLJ18502WA T=1.40mm 0.974kg/m	

注：图中所示为标注厚度的理论重量，实际重量以过磅时的重量为准。

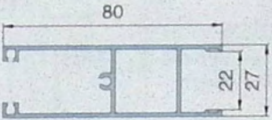
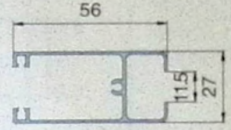
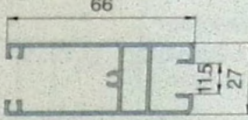
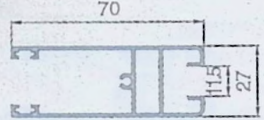
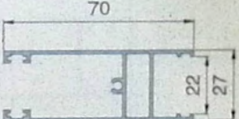
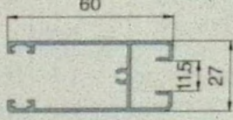
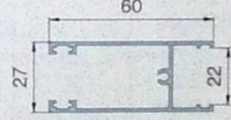
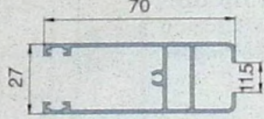
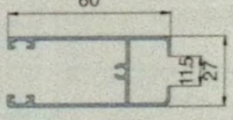
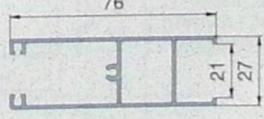
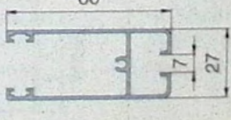
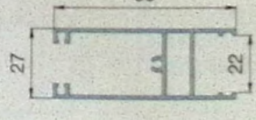
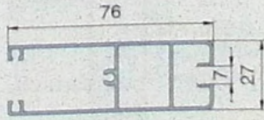
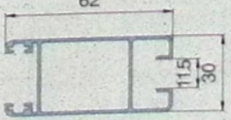
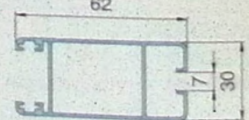

型号厚度 米重/kgm	产品图例	型号厚度 米重/kgm	产品图例	型号厚度 米重/kgm	产品图例
YLJ18502WP* T=(1.20mm) 0.866kg/m		YLJ18502Y T=1.20mm 0.958kg/m		YLJ18502PA T=1.40mm 0.849kg/m	
YLJ18502JP* T=1.20mm 0.735kg/m		YLJ18502HT T=1.40mm 1.514kg/m		YLJ18502KDT T=1.40mm 0.294kg/m	
YLJ18503 T=1.20mm 0.608kg/m		YLJ18503A T=1.20mm 0.645kg/m		YLJ18503C T=1.20mm 0.657kg/m	
YLJ18503P* T=(1.20mm) 0.578kg/m		YLJ18503AT T=1.40mm 0.766kg/m		YLJ18503AP* T=(1.20mm) 0.599kg/m	
YLJ18503DT T=1.40mm 0.746kg/m		YLJ18503B T=1.20mm 1.030kg/m		YLJ18503BT T=1.40mm 1.199kg/m	
YLJ18504A T=1.20mm 0.603kg/m		YLJ18504ZK T=1.20mm 0.549kg/m		YLJ18504T T=1.40mm 0.673kg/m	
YLJ18504AT T=1.40mm 0.676kg/m		YLJ18504TZK T=1.40mm 0.613kg/m		YLJ18504P* T=(1.20mm) 0.598kg/m	
YLJ18504AP* T=(1.20mm) 0.568kg/m		YLJ18504CZK T=1.20mm 0.742kg/m			

型号厚度 米重/kgm	产品图例	型号厚度 米重/kgm	产品图例	型号厚度 米重/kgm	产品图例
YLJ18504CTZK T=1.40mm 0.891kg/m		YLJ18504DP* T=(1.20mm) 0.563kg/m		YLJ18505 T=1.20mm 0.748kg/m	
YLJ18505A T=1.20mm 0.780kg/m YLJ18505AT T=1.40mm 0.873kg/m		YLJ18505AZK T=1.20mm 0.733kg/m		YLJ18505B T=1.20mm 0.634kg/m YLJ18505BT T=1.40mm 0.704kg/m	
YLJ18505BZK T=1.20mm 0.587kg/m		YLJ18505EP* T=(1.20mm) 0.724kg/m		YLJ18505DP* T=(1.20mm) 0.584kg/m	
YLJ18505DZK T=1.20mm 0.732kg/m		YLJ18505F T=1.20mm 0.638kg/m		YLJ18505ZK T=1.20mm 0.701kg/m	
YLJ18505ZYP T=1.20mm 0.799kg/m		YLJ18506 T=1.20mm 0.746kg/m YLJ18506T T=1.40mm 0.848kg/m		YLJ18506A T=1.20mm 0.741kg/m YLJ18506AT T=1.40mm 0.848kg/m	

注：图中所示为标注厚度的理论重量，实际重量以过磅时的重量为准。



型号厚度 米重/kgm	产品图例	型号厚度 米重/kgm	产品图例	型号厚度 米重/kgm	产品图例
YLJ18506AP* T=(1.20mm) 0.722kg/m		YLJ18506P* T=(1.20mm) 0.729kg/m		YLJ18506CP* T=(1.20mm) 0.694kg/m	
YLJ18506ZK T=1.20mm 0.706kg/m		YLJ18506KD T=1.20mm 0.924kg/m		YLJ18506W T=1.60mm 0.957kg/m	
YLJ18507 T=1.20mm 0.648kg/m		YLJ18507P* T=(1.20mm) 0.669kg/m		YLJ18507A T=1.20mm 0.697kg/m	
YLJ18507T T=1.40mm 0.795kg/m		YLJ18507DP* T=(1.20mm) 0.633kg/m		YLJ18507AT T=1.40mm 0.797kg/m	
YLJ18507AP* T=(1.20mm) 0.666kg/m		YLJ18507FP* T=(1.20mm) 0.659kg/m		YLJ18507G* T=(1.20mm) 0.649kg/m	
YLJ18507G* T=(1.20mm) 0.649kg/m		YLJ18507ZK T=1.20mm 0.659kg/m		YLJ18507KD T=1.20mm 0.867kg/m	
		YLJ18507TZK T=1.40mm 0.748kg/m			

型号厚度 米重/kgm	产品图例	型号厚度 米重/kgm	产品图例	型号厚度 米重/kgm	产品图例
Y LJ18510 T=1.20mm 0.682kg/m Y LJ18510T T=1.40mm 0.754kg/m Y LJ18510P* T=(1.20mm) 0.627kg/m		Y LJ18510A T=1.20mm 0.684kg/m Y LJ18510AP* T=(1.20mm) 0.660kg/m		Y LJ18510E T=1.20mm 0.639kg/m Y LJ18510EP* T=(1.20mm) 0.608kg/m	
Y LJ18510FP* T=(1.20mm) 0.591kg/m		Y LJ18510G T=1.40mm 0.801kg/m		Y LJ18510AZK T=1.20mm 0.733kg/m Y LJ18510ATZK T=1.40mm 0.833kg/m	
Y LJ18510ZK T=1.20mm 0.674kg/m Y LJ18510TZK T=1.40mm 0.754kg/m		Y LJ18511 T=1.20mm 0.453kg/m Y LJ18511P T=1.00mm 0.391kg/m		Y LJ18511A T=1.20mm 0.402kg/m Y LJ18511AP T=1.00mm 0.332kg/m	
Y LJ18511B T=1.10mm 0.404kg/m Y LJ18511BP T=1.00mm 0.375kg/m		Y LJ18511ZK T=1.20mm 0.458kg/m		Y LJ18512 T=1.10mm 0.378kg/m Y LJ18512T T=1.40mm 0.447kg/m	
Y LJ18512A T=1.20mm 0.396kg/m		Y LJ18512AZK T=1.10mm 0.372kg/m		Y LJ18512ZK T=1.10mm 0.378kg/m	

注: 图中所示为标注厚度的理论重量, 实际重量以过磅时的重量为准。



型号厚度 米重/kgm	产品图例	型号厚度 米重/kgm	产品图例	型号厚度 米重/kgm	产品图例
YLJ18513 T=1.20mm 0.870kg/m YLJ18513T T=1.40mm 0.982kg/m YLJ18513P* T=(1.20mm) 0.844kg/m		YLJ18513A T=1.20mm 0.767kg/m		YLJ18513AP* T=(1.20mm) 0.731kg/m	
YLJ18513AZK T=1.20mm 0.989kg/m		YLJ18513CP* T=(1.20mm) 0.935kg/m		YLJ18513ZK T=1.20mm 0.815kg/m YLJ18513TZK T=1.40mm 0.973kg/m	
YLJ18508 T=1.00mm 0.257kg/m		YLJ18508A T=1.00mm 0.287kg/m		YLJ18508BP T=0.80mm 0.119kg/m	
YLJ18509 T=0.90mm 0.316kg/m		YLJ18509A T=0.90mm 0.310kg/m YLJ18509AP T=0.80mm 0.279kg/m		YLJ18509D T=0.80mm 0.278kg/m	
YLJ18514 T=1.20mm 0.145kg/m		YLJ18514A T=1.20mm 0.131kg/m		YLJ18514B T=1.20mm 0.130kg/m	

85系列推拉窗型材图(新90系列)

Aluminium Profiles for Series 85 Sliding Window(new 90 series)

永利坚铝材 YONGLIJIAN



型号厚度 米重/kgm	产品图例	型号厚度 米重/kgm	产品图例	型号厚度 米重/kgm	产品图例
YLJ18514P T=0.80mm 0.098kg/m		YLJ18515 T=1.20mm 0.351kg/m		YLJ18515A T=1.20mm 0.361kg/m	
YLJ18515B T=1.20mm 0.407kg/m		YLJ18516 T=1.20mm 0.691kg/m		YLJ18516A T=1.20mm 0.360kg/m	
YLJ18517 T=1.20mm 0.869kg/m		YLJ18517ZK T=1.20mm 1.231kg/m		YLJ18518 T=1.20mm 1.086kg/m	
YLJ18518ZK T=1.20mm 1.325kg/m		YLJ18519 T=1.20mm 0.932kg/m		YLJ18520TZK T=1.40mm 1.028kg/m	
YLJ18540 T=1.20mm 0.521kg/m		YLJ18542 T=1.10mm 0.502kg/m		YLJ18549 T=1.40mm 0.359kg/m	

注：图中所示为标注厚度的理论重量，实际重量以过磅时的重量为准。

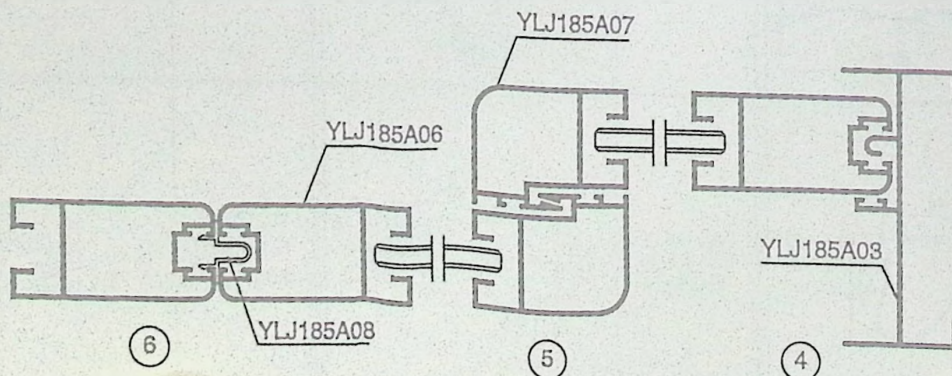
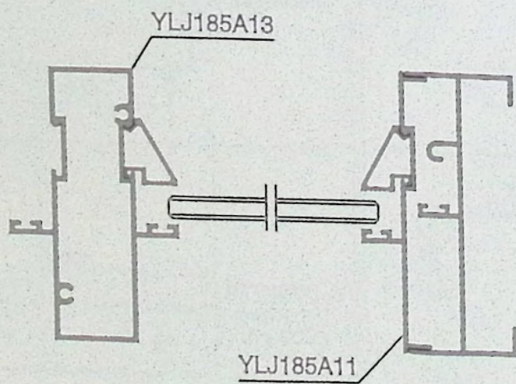
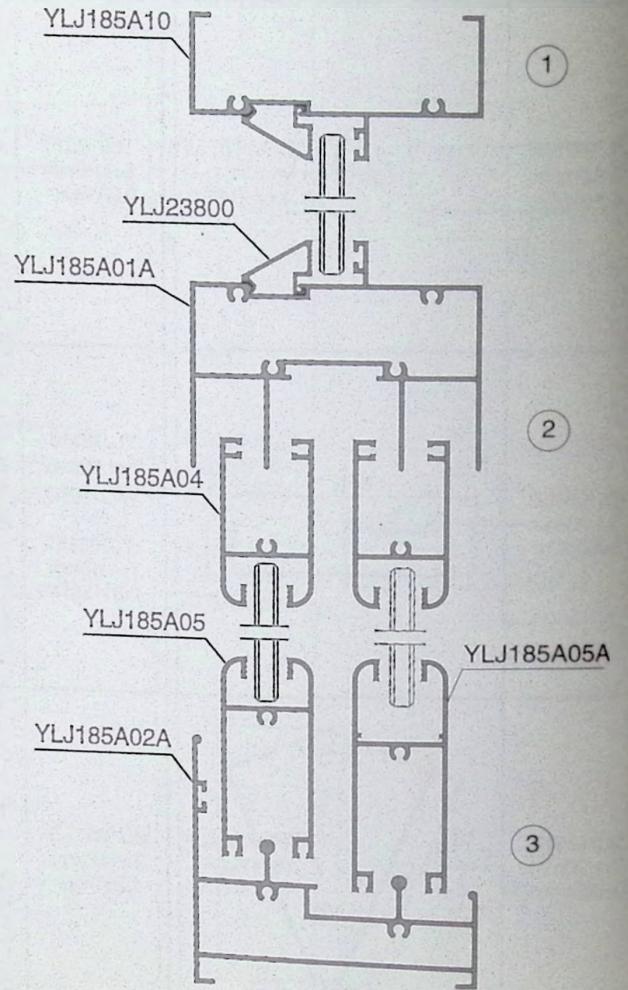
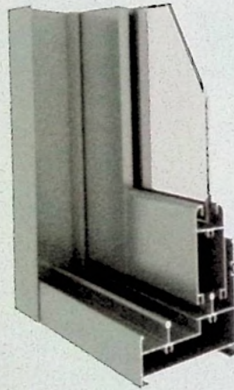
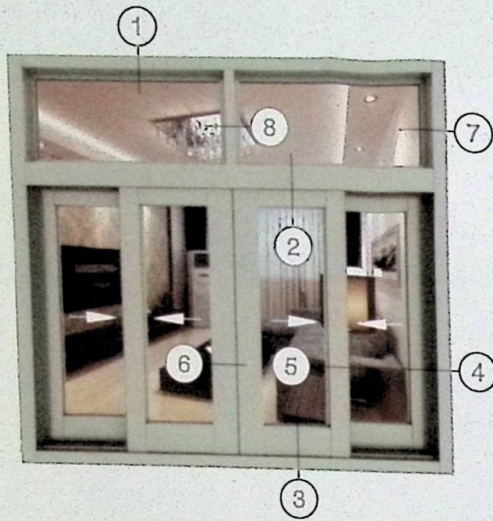

85A系列推拉窗结构图
Structure Diagram of Series 85A Sliding Window

永利坚铝材 YONGLIJIAN

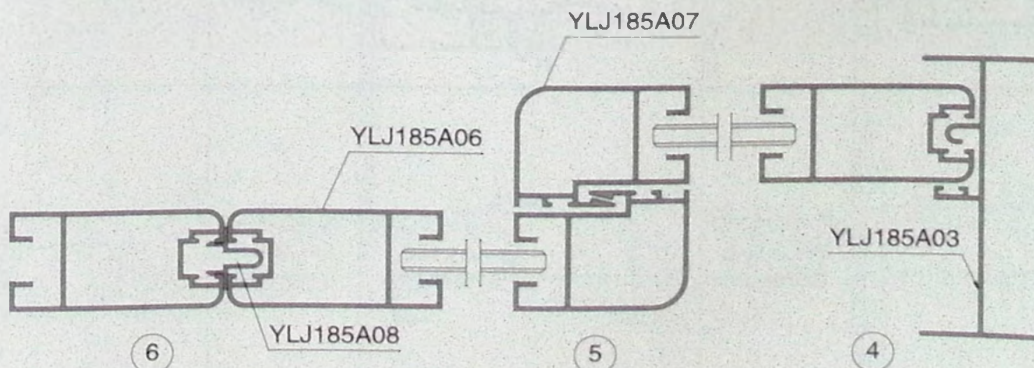
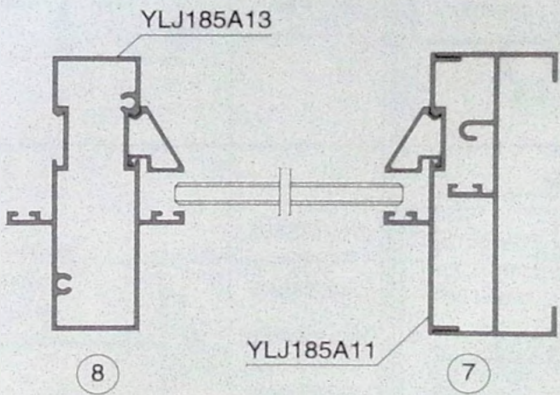
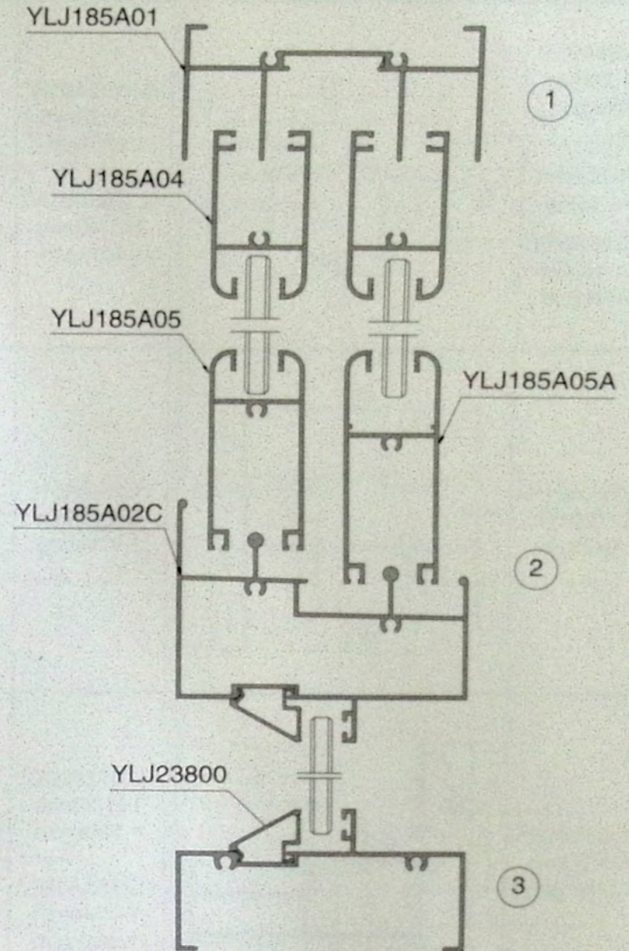
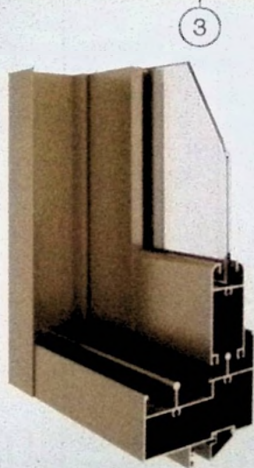
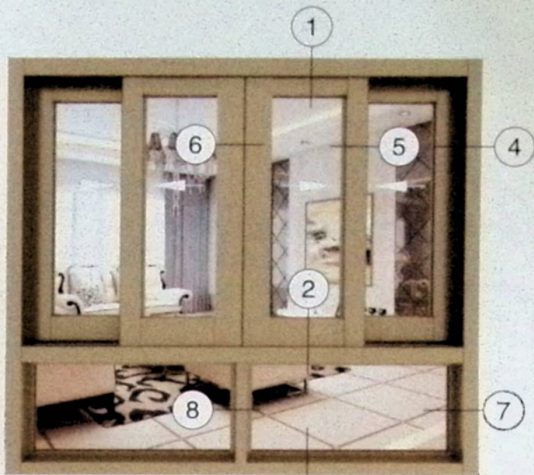



型号厚度 米重/kgm	产品图例	型号厚度 米重/kgm	产品图例	型号厚度 米重/kgm	产品图例
YLJ185A01D T=1.20mm 0.828kg/m YLJ185A01* T=(1.20)mm 0.790kg/m YLJ185A01T T=1.40mm 0.941kg/m		YLJ185A01A* T=1.20mm 1.288kg/m YLJ185A01AT T=1.40mm 1.491kg/m		YLJ185A01K T=1.20mm 0.983kg/m	
YLJ185A01KA T=1.20mm 1.437kg/m		YLJ185A01L T=1.40mm 1.436kg/m		YLJ185A02D T=1.20mm 1.134kg/m YLJ185A02T T=1.40mm 1.284kg/m	
YLJ185A02A T=1.20mm 1.286kg/m		YLJ185A02C* T=1.20mm 1.139kg/m YLJ185A02CT T=1.40mm 1.362kg/m		YLJ185A02F T=1.20mm 0.773kg/m	
YLJ185A02K T=1.20mm 1.220kg/m		YLJ185A02N T=1.20mm 1.293kg/m		YLJ185A03 T=1.20mm 0.676kg/m YLJ185A03T T=1.40mm 0.768kg/m	
YLJ185A03A T=1.20mm 1.164kg/m YLJ185A03AT T=1.40mm 1.342kg/m		YLJ185A03D T=1.20mm 0.676kg/m		YLJ185A04* T=1.20mm 0.553kg/m	

85A系列推拉窗型材图

Aluminium Profiles for Series 85A Sliding Window

永利坚铝材 YONGLIJIAN



型号厚度 米重/kgm	产品图例	型号厚度 米重/kgm	产品图例	型号厚度 米重/kgm	产品图例
YLJ185A04D T=1.20mm 0.569kg/m		YLJ185A04T T=1.40mm 0.623kg/m		YLJ185A05° T=1.20mm 0.615kg/m	
YLJ185A05A* T=1.20mm 0.684kg/m		YLJ185A05AT T=1.40mm 0.777kg/m		YLJ185A05BZK* T=1.20mm 0.558kg/m	
YLJ185A05AD T=1.20mm 0.704kg/m		YLJ185A05D T=1.20mm 0.633kg/m		YLJ185A05T T=1.40mm 0.698kg/m	YLJ185A06D T=1.20mm 0.771kg/m
YLJ185A06ZK T=1.20mm 0.704kg/m		YLJ185A07* T=(1.20)mm 0.651kg/m		YLJ185A06° T=(1.20)mm 0.718kg/m	
YLJ185A07CZK T=1.20mm 0.645kg/m		YLJ185A07D T=1.20mm 0.687kg/m		YLJ185A07B T=1.20mm 0.677kg/m	
YLJ185A07CZK T=1.20mm 0.645kg/m		YLJ185A07BZK T=1.20mm 0.636kg/m		YLJ185A07ZK T=1.20mm 0.613kg/m	
YLJ185A07ZK T=1.20mm 0.613kg/m		YLJ185A07ZK T=1.20mm 0.613kg/m		YLJ185A07ZK T=1.20mm 0.613kg/m	

注：图中所示为标注厚度的理论重量，实际重量以过磅时的重量为准。



型号厚度 米重/kgm	产品图例	型号厚度 米重/kgm	产品图例	型号厚度 米重/kgm	产品图例
YLJ185A07T T=1.40mm 0.782kg/m		YLJ185A08 T=0.80mm 0.106kg/m		YLJ185A09 T=1.00mm 0.380kg/m	
YLJ185A10L T=1.40mm 0.775kg/m		YLJ185A10K T=1.20mm 0.616kg/m		YLJ185A10* T=(1.20)mm 0.637kg/m	
YLJ185A10N* T=1.20mm 0.896kg/m		YLJ185A11 T=1.10mm 0.409kg/m		YLJ185A11L T=1.00mm 0.298kg/m	
YLJ185A12 T=1.20mm 0.399kg/m		YLJ185A12A T=1.20mm 0.411kg/m		YLJ185A13* T=1.20mm 0.909kg/m	
YLJ185A13A* T=(1.20)mm 0.995kg/m		YLJ185A13K T=1.20mm 0.954kg/m		YLJ185A13L T=1.20mm 0.816kg/m	

85A系列推拉窗型材图

Aluminium Profiles for Series 85A Sliding Window

永利坚铝材 YONGLIJIAN



型号厚度 米重/kgm	产品图例	型号厚度 米重/kgm	产品图例	型号厚度 米重/kgm	产品图例
YLJ185A17 T=1.20mm 0.478kg/m		YLJ185A18 T=1.20mm 1.148kg/m		YLJ185A19 T=1.20mm 0.914kg/m	
YLJ185A23AT T=1.40mm 1.606kg/m		YLJ185A23BT T=1.40mm 1.606kg/m			

注：图中所示为标注厚度的理论重量，实际重量以过磅时的重量为准。

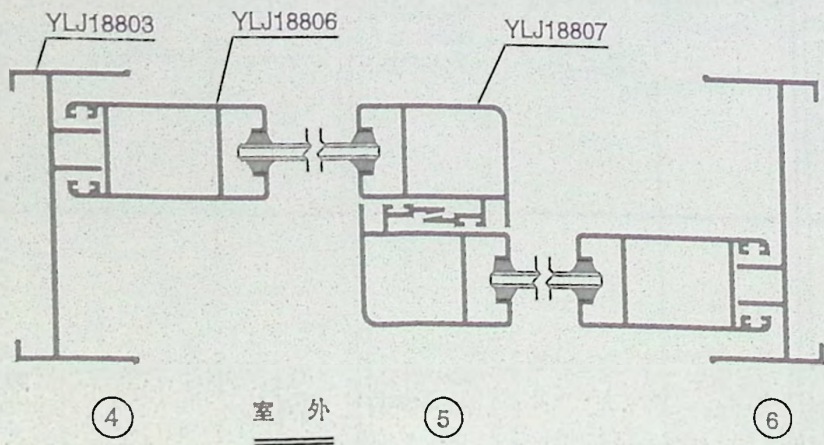
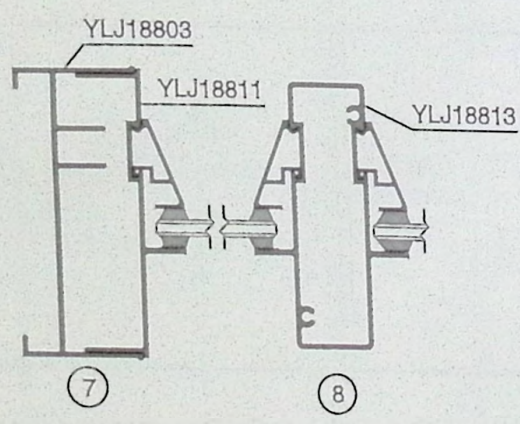
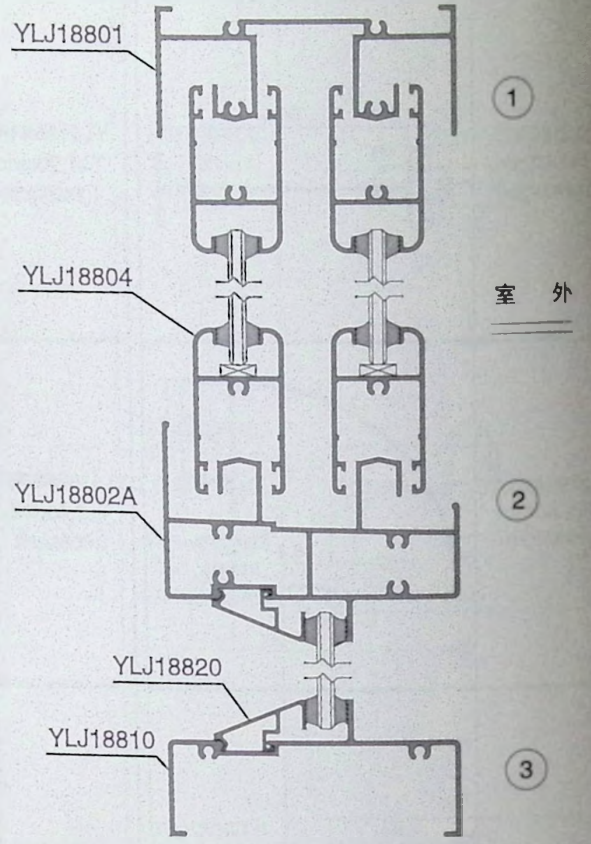
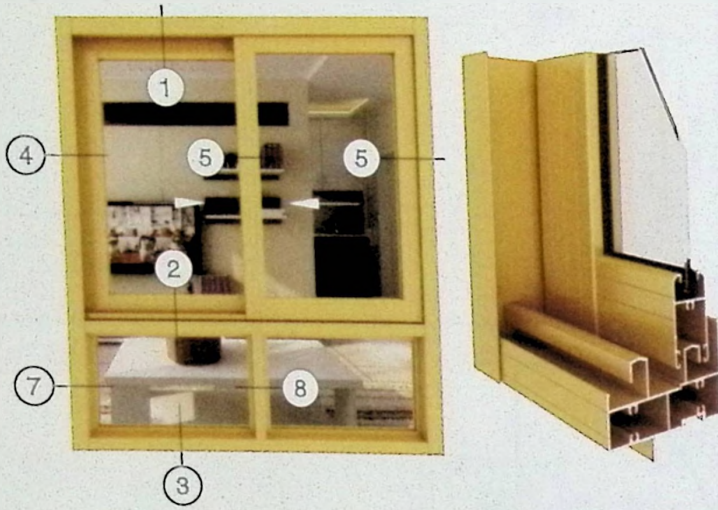

88系列推拉窗结构图

Structure Diagram of Series 88 Sliding Window

永利坚铝材 YONGLIJIAN

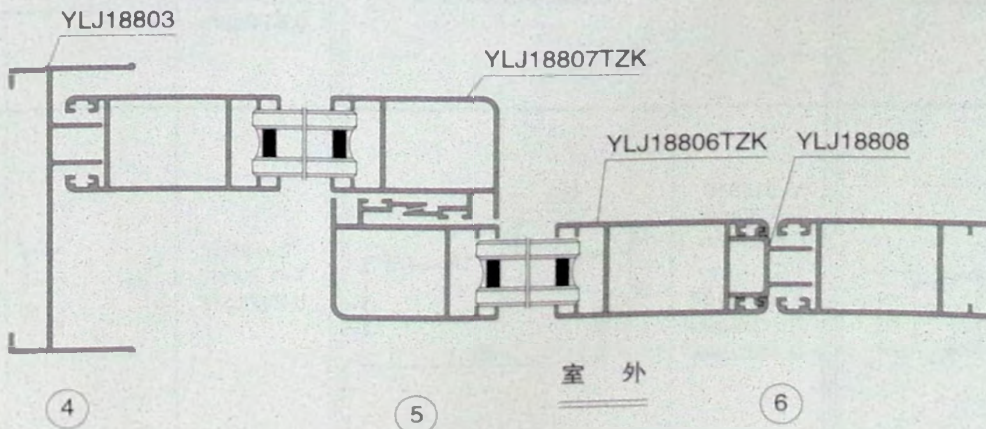
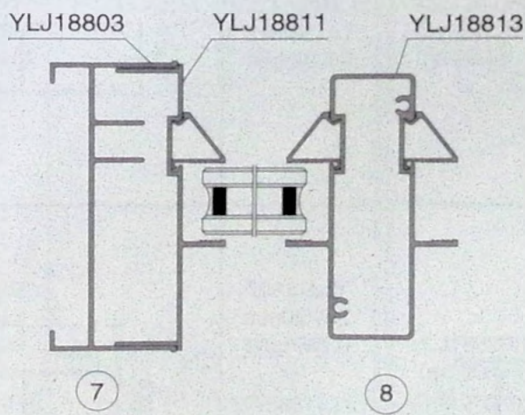
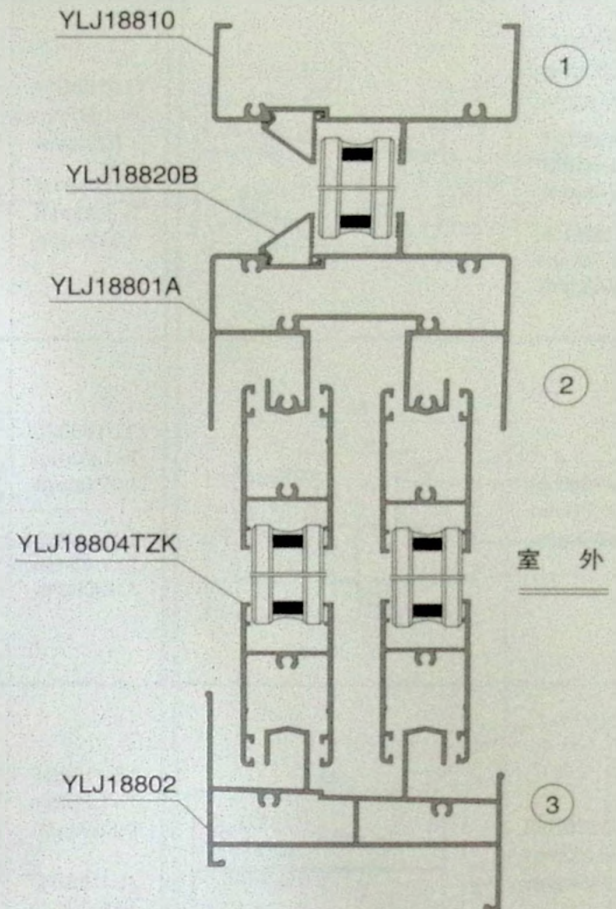
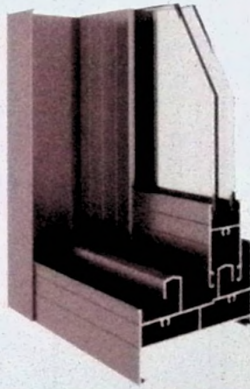
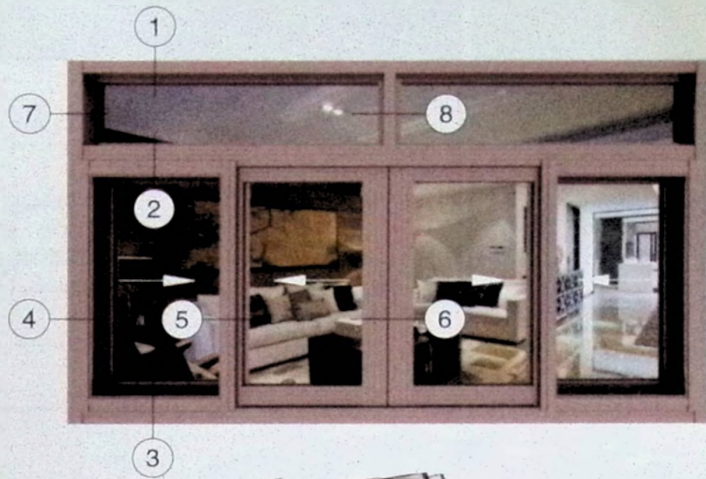



型号厚度 米重/kgm	产品图例	型号厚度 米重/kgm	产品图例	型号厚度 米重/kgm	产品图例
YLJ18801 T=1.20mm 1.087kg/m YLJ18801T T=1.45mm 1.214kg/m YLJ18801H T=1.70mm 1.350kg/m		YLJ18801A T=1.20mm 1.623kg/m YLJ18801AT T=1.45mm 1.812kg/m		YLJ18802 T=1.20mm 1.322kg/m YLJ18802T T=1.26mm 1.370kg/m	
YLJ18802A T=1.26mm 1.495kg/m		YLJ18802C T=1.20mm 1.271kg/m YLJ18802CT T=1.40mm 1.430kg/m		YLJ18803 T=1.20mm 0.715kg/m YLJ18803T T=1.45mm 0.806kg/m	
YLJ18803A T=1.20mm 1.045kg/m		YLJ18804 T=1.20mm 0.548kg/m YLJ18804T T=1.40mm 0.611kg/m		YLJ18804TZK T=1.40mm 0.540kg/m	
YLJ18806 T=1.20mm 0.747kg/m YLJ18806T T=1.40mm 0.853kg/m		YLJ18806TZK T=1.40mm 0.815kg/m		YLJ18807 T=1.20mm 0.700kg/m YLJ18807T T=1.40mm 0.814kg/m	
YLJ18807TZK T=1.40mm 0.767kg/m		YLJ18810 T=1.20mm 0.676kg/m YLJ18810T T=1.45mm 0.767kg/m		YLJ18808 T=1.20mm 0.237kg/m	

88系列推拉窗型材图

Aluminium Profiles for Series 88 Sliding Window

永利坚铝材 YONGLIJIAN



型号厚度 米重/kgm	产品图例	型号厚度 米重/kgm	产品图例	型号厚度 米重/kgm	产品图例
YLJ18811 T=1.20mm 0.514kg/m		YLJ18812 T=1.20mm 0.418kg/m		YLJ18813 T=1.20mm 0.960kg/m YLJ18813T T=1.45mm 1.101kg/m	
YLJ18813C T=1.40mm 1.219kg/m		YLJ18815 T=1.20mm 0.357kg/m		YLJ18816 T=1.20mm 0.750kg/m	
YLJ18817 T=1.20mm 0.421kg/m		YLJ18817A T=1.10mm 0.298kg/m		YLJ18818 T=1.30mm 1.385kg/m	
YLJ18820 T=0.90mm 0.160kg/m YLJ18820PT T=0.90mm 0.158kg/m		YLJ18820B T=0.90mm 0.110kg/m		YLJ18820A T=0.80mm 0.101kg/m	
YLJ18820D T=0.90mm 0.110kg/m YLJ18820DPT T=0.90mm 0.110kg/m					

注：图中所示为标注厚度的理论重量，实际重量以过磅时的重量为准。

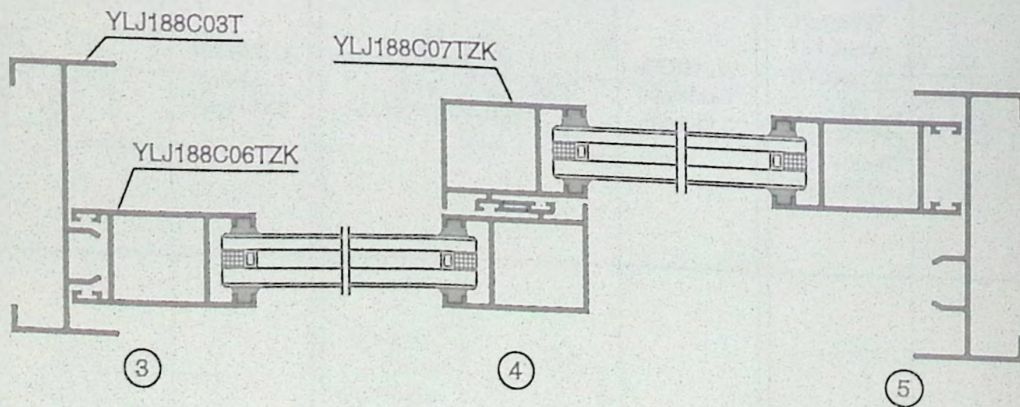
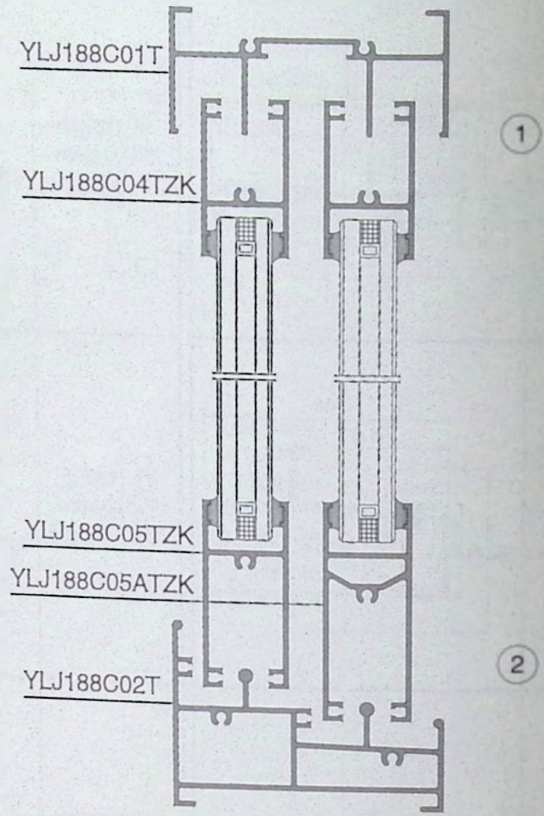
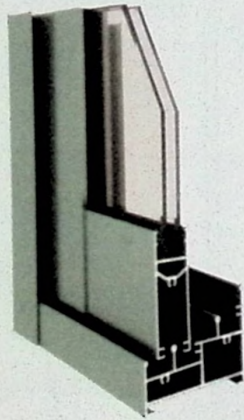
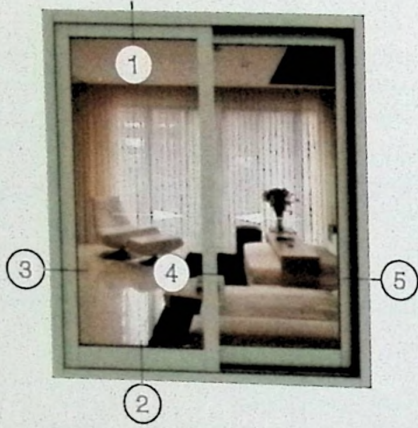

88C系列推拉窗 (中空) 结构图
Structure Diagram of Series 88C Sliding Window(Hollow)

永利坚铝材 YONGLIJIAN

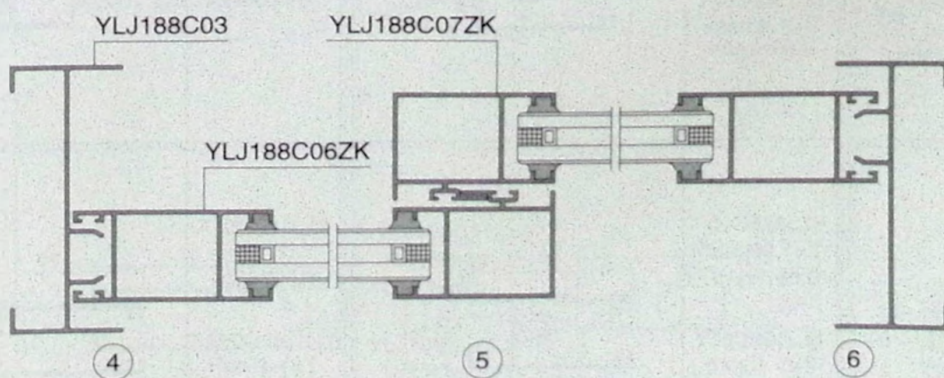
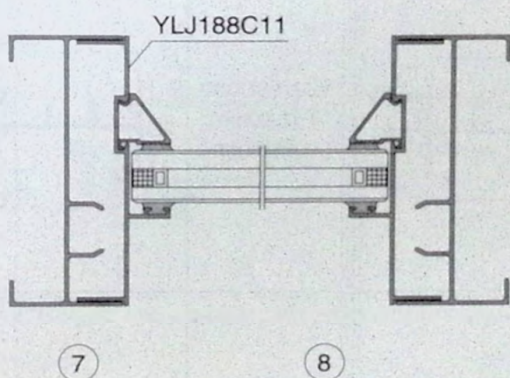
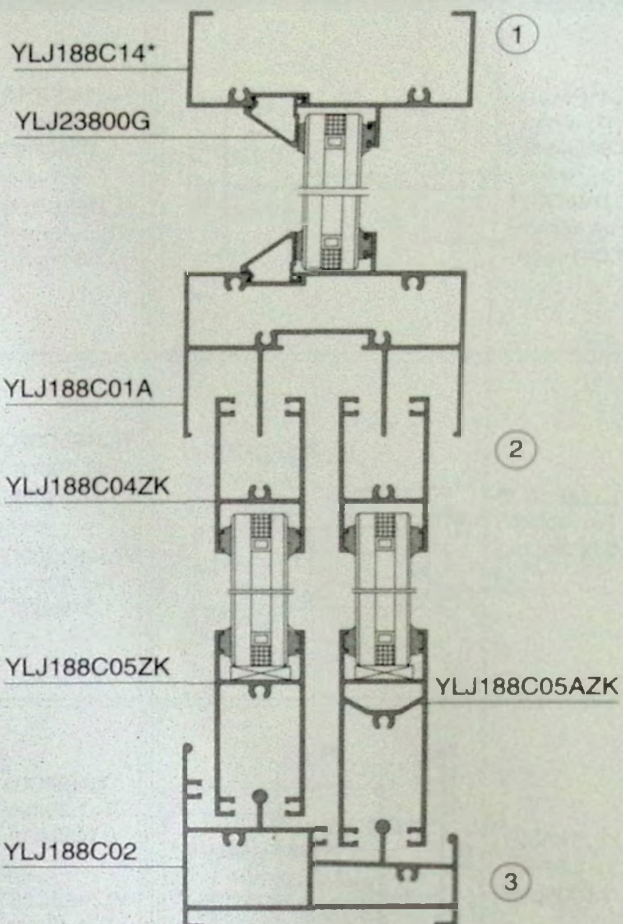
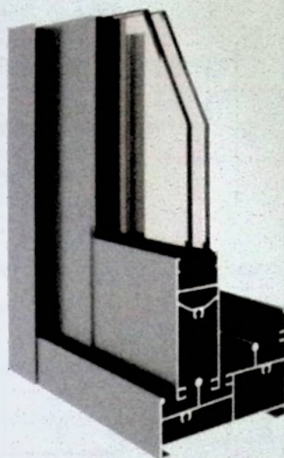
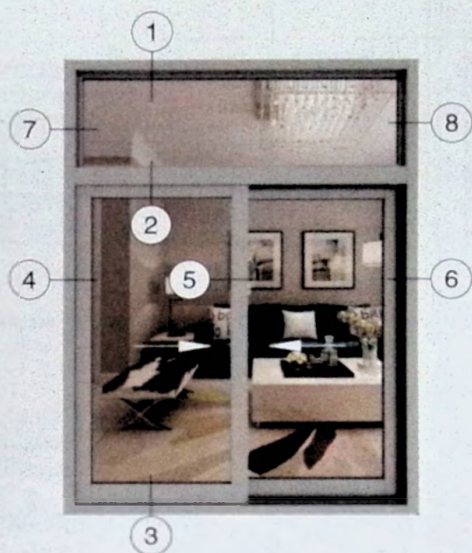



型号厚度 米重/kgm	产品图例	型号厚度 米重/kgm	产品图例	型号厚度 米重/kgm	产品图例
YLJ188C01 T=1.20mm 0.852kg/m YLJ188C01T T=1.45mm 1.001kg/m		YLJ188C01A T=1.20mm 1.375kg/m YLJ188C01AT T=1.45mm 1.584kg/m		YLJ188C02 T=1.20mm 1.261kg/m YLJ188C02T T=1.45mm 1.470kg/m	
YLJ188C02B T=1.40mm 0.923kg/m		YLJ188C02C T=1.20mm 1.226kg/m YLJ188C02CT T=1.40mm 1.375kg/m		YLJ188C02H T=1.90mm 0.931kg/m	
YLJ188C21 T=1.20mm 1.603kg/m		YLJ188C03 T=1.20mm 0.633kg/m YLJ188C03T T=1.45mm 0.762kg/m		YLJ188C03D T=1.20mm 0.681kg/m	
YLJ188C03K T=1.40mm 0.762kg/m		YLJ188C04 T=1.20mm 0.601kg/m YLJ188C04T T=1.45mm 0.681kg/m		YLJ188C04BZK T=1.40mm 0.593kg/m	
YLJ188C04ZK T=1.20mm 0.536kg/m YLJ188C04TZK T=1.45mm 0.611kg/m		YLJ188C05 T=1.20mm 0.667kg/m YLJ188C05T T=1.45mm 0.760kg/m		YLJ188C05A T=1.20mm 0.823kg/m YLJ188C05AT T=1.45mm 0.937kg/m	

88C系列推拉窗型材图

Aluminium Profiles for Series 88C Sliding Window

永利坚铝材 YONGLIJIAN



型号厚度 米重/kgm	产品图例	型号厚度 米重/kgm	产品图例	型号厚度 米重/kgm	产品图例
YLJ188C05ZK T=1.20mm 0.602kg/m		YLJ188C05AZK T=1.20mm 0.758kg/m		YLJ188C05BZK T=1.40mm 0.766kg/m	
YLJ188C05TZK T=1.45mm 0.690kg/m		YLJ188C05ATZK T=1.45mm 0.877kg/m			
YLJ188C06 T=1.20mm 0.728kg/m		YLJ188C06ZK T=1.20mm 0.673kg/m		YLJ188C07 T=1.20mm 0.710kg/m	
YLJ188C06T T=1.45mm 0.856kg/m		YLJ188C06TZK T=1.45mm 0.799kg/m		YLJ188C07T T=1.45mm 0.824kg/m	
YLJ188C07TB T=1.45mm 1.179kg/m		YLJ188C07TC T=1.45mm 1.203kg/m		YLJ188C07BZK T=1.40mm 0.710kg/m	
YLJ188C07ZK T=1.20mm 0.651kg/m		YLJ188C08 T=1.40mm 0.256kg/m		YLJ188C08A T=1.00mm 0.261kg/m	
YLJ188C07TZK T=1.45mm 0.763kg/m		YLJ188C08B T=1.00mm 0.265kg/m			
YLJ188C10 T=1.50mm 0.895kg/m		YLJ188C11 T=1.20mm 0.477kg/m		YLJ188C12 T=1.26mm 0.410kg/m	
		YLJ188C11T T=1.45mm 0.560kg/m			

注：图中所示为标注厚度的理论重量，实际重量以过磅时的重量为准。



型号厚度 米重/kgm	产品图例	型号厚度 米重/kgm	产品图例	型号厚度 米重/kgm	产品图例
YLJ188C13T T=1.45mm 1.049kg/m		YLJ188C14T T=1.45mm 0.783kg/m		YLJ188C15 T=1.40mm 1.623kg/m	

90系列推拉窗结构图

Structure Diagram of Series 90 Sliding Window

永利坚铝材 YONGLIJIAN

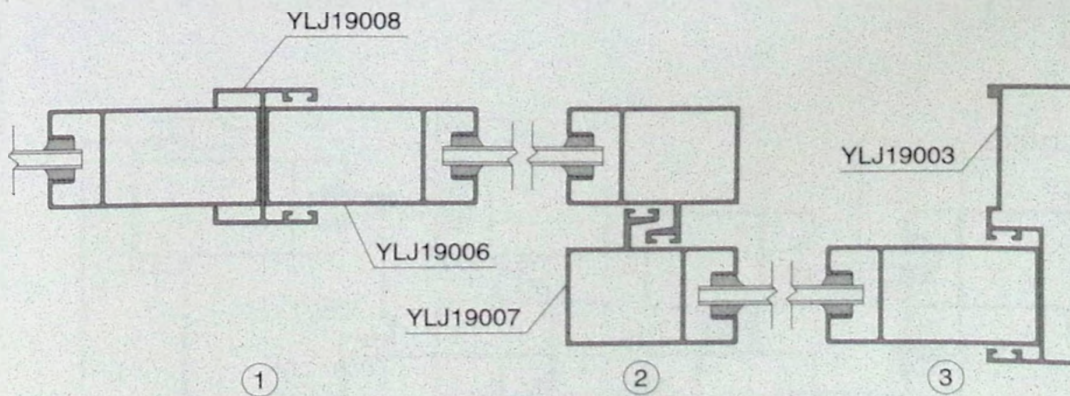
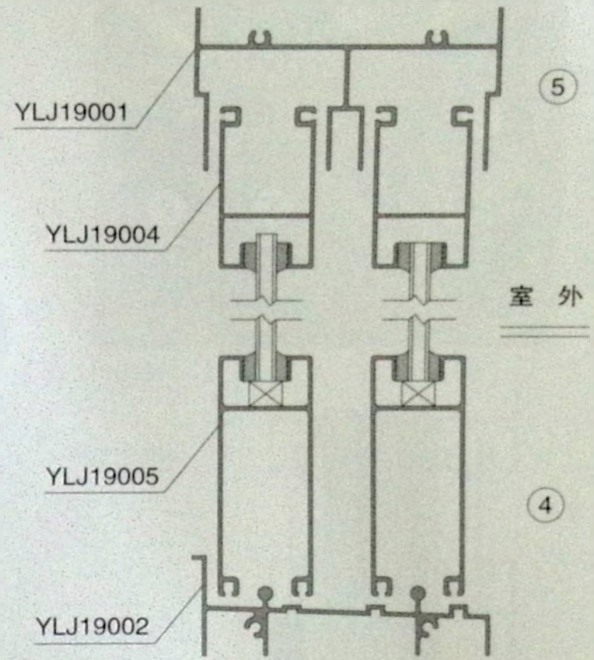
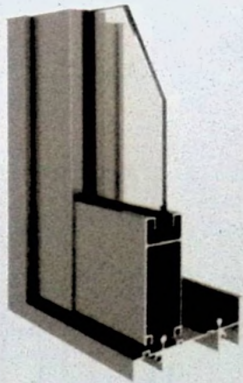
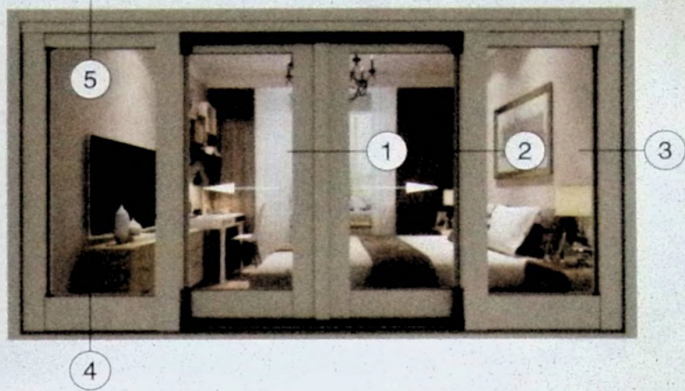

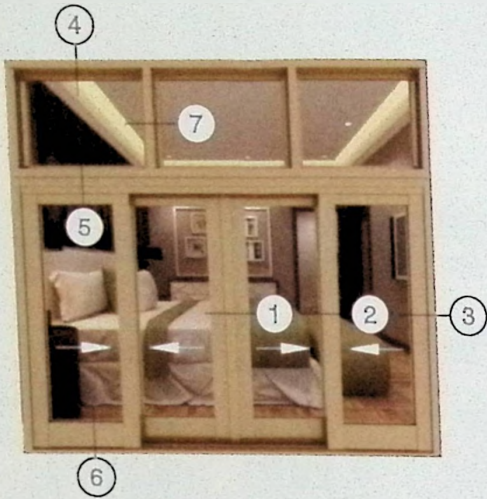

6

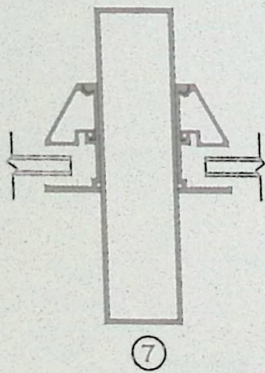
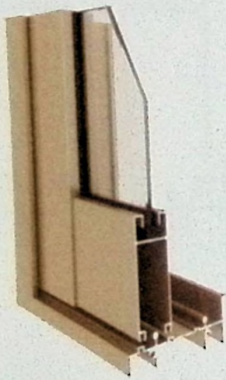

7

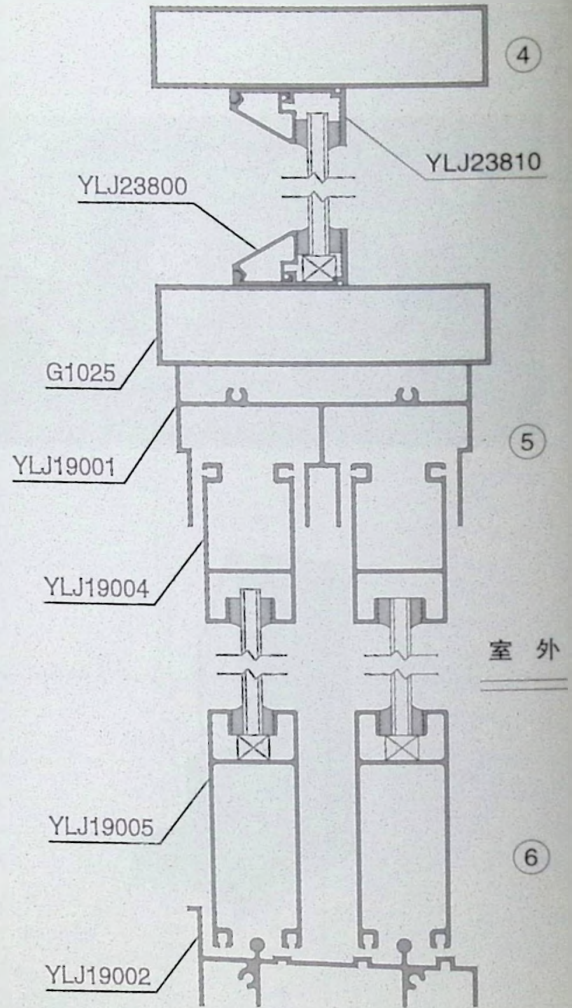

室外

6

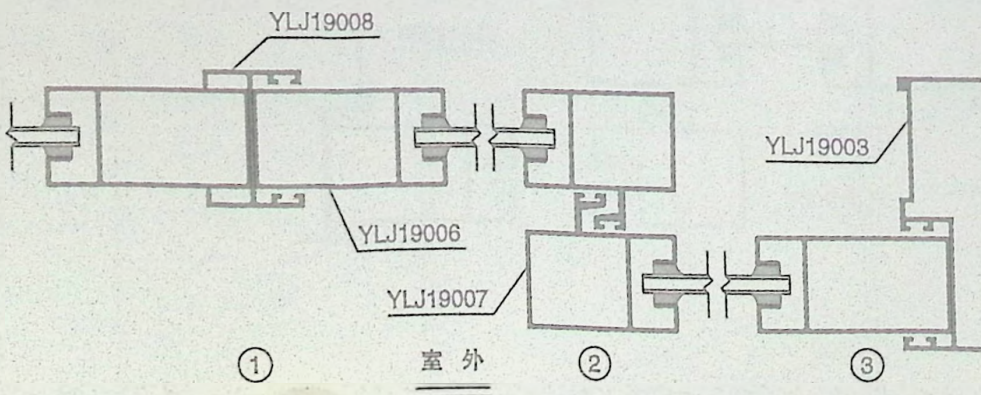

1

2

3

90系列推拉窗结构图

Structure Diagram of Series 90 Sliding Window

永利坚铝材 YONGLIJIAN

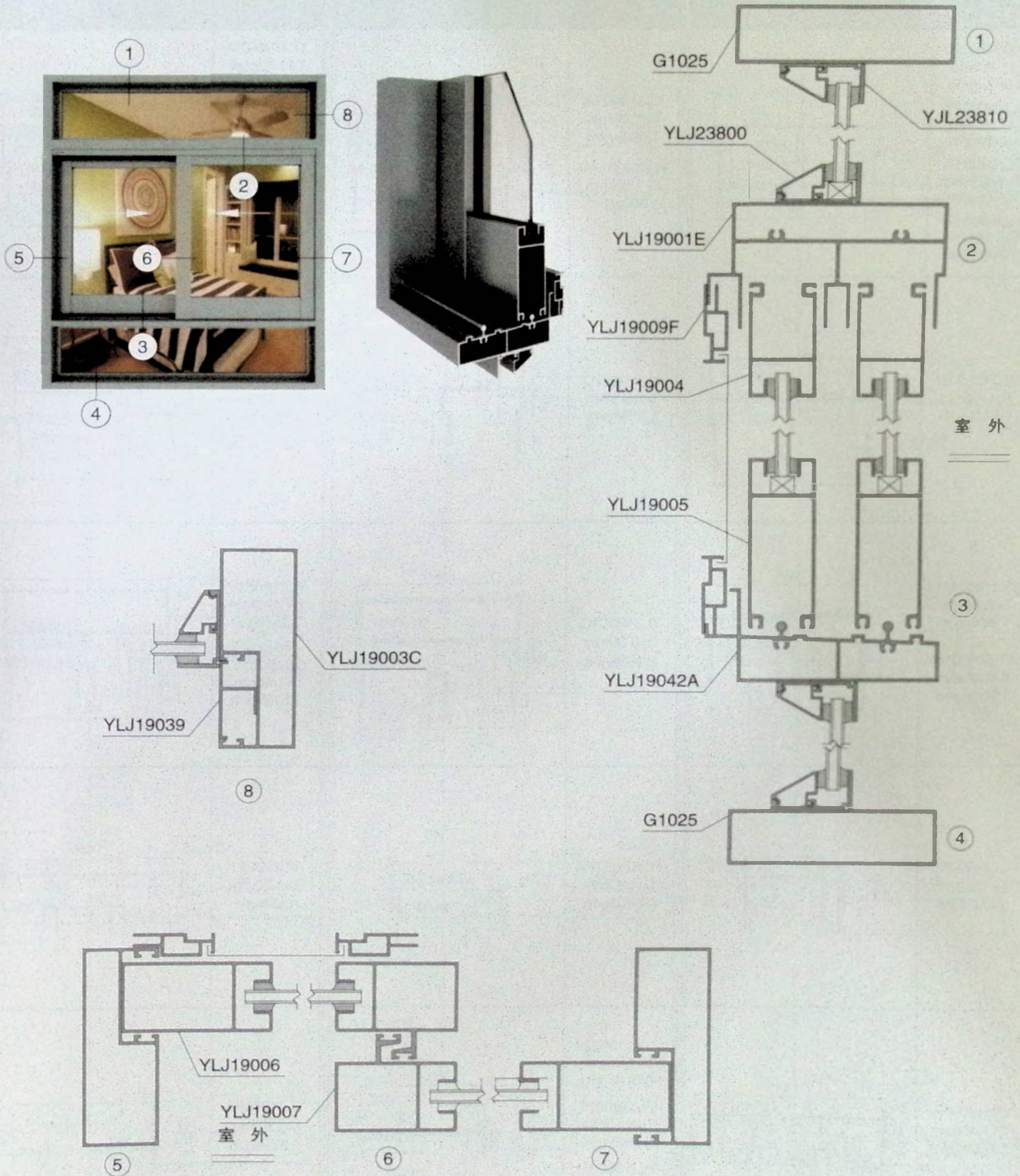



型号厚度 米重/kgm	产品图例	型号厚度 米重/kgm	产品图例	型号厚度 米重/kgm	产品图例
YLJ19001 T=1.20mm 0.963kg/m YLJ19001P* T=1.20mm 0.899kg/m YLJ19001T T=1.40mm 1.110kg/m YLJ19001H T=1.60mm 1.209kg/m		YLJ19001A T=1.20mm 1.084kg/m YLJ19001AH T=1.60mm 1.362kg/m		YLJ19001B T=1.20mm 1.027kg/m YLJ19001BA T=1.25mm 1.008kg/m YLJ19001BT T=1.40mm 1.120kg/m YLJ19001BH T=1.80mm 1.375kg/m	
YLJ19001C T=1.40mm 1.621kg/m		YLJ19001D T=1.40mm 1.064kg/m		YLJ19001E T=1.20mm 1.380kg/m	
YLJ19001FH T=2.00mm 1.464kg/m YLJ19001H T=1.60mm 1.209kg/m		YLJ19001G T=2.00mm 2.105kg/m		YLJ19001F T=1.20mm 1.351kg/m YLJ19001FT T=1.40mm 1.512kg/m	
YLJ19001FB* T=1.20mm 0.462kg/m		YLJ19001FA T=1.20mm 0.590kg/m		YLJ19031 T=1.20mm 1.334kg/m	
YLJ19031A T=1.40mm 1.598kg/m		YLJ19002 T=1.20mm 0.815kg/m YLJ19002T T=1.40mm 0.866kg/m YLJ19002H T=1.60mm 0.951kg/m		YLJ19002A T=1.20mm 0.879kg/m	

90系列推拉窗型材图

Aluminium Profiles for Series 90 Sliding Window

永利坚铝材 YONGLIJIAN



型号厚度 米重/kgm	产品图例	型号厚度 米重/kgm	产品图例	型号厚度 米重/kgm	产品图例
YLJ19002B T=1.26mm 0.901kg/m YLJ19002BT T=1.40mm 0.977kg/m		YLJ19002FH T=1.80mm 1.333kg/m		YLJ19002E T=1.60mm 0.998kg/m	
YLJ19022E T=1.20mm 1.040kg/m YLJ19022ET T=1.40mm 1.151kg/m		YLJ19022F T=1.20mm 0.786kg/m		YLJ19022FH T=1.40mm 0.884kg/m	
YLJ19022FT T=1.45mm 0.914kg/m		YLJ19022T T=1.40mm 0.946kg/m		YLJ19032 T=1.80mm 1.674kg/m	
YLJ19032A T=1.35mm 1.267kg/m		YLJ19032B T=1.30mm 1.177kg/m		YLJ19040 T=1.20mm 0.562kg/m	
YLJ19042A T=1.20mm 1.109kg/m		YLJ19003 T=1.26mm 0.650kg/m YLJ19003FH T=2.00mm 0.910kg/m YLJ19003H T=1.60mm 0.772kg/m YLJ19003T T=1.40mm 0.690kg/m		YLJ19003A T=1.20mm 0.715kg/m	

注：图中所示为标注厚度的理论重量，实际重量以过磅时的重量为准。



型号厚度 米重/kgm	产品图例	型号厚度 米重/kgm	产品图例	型号厚度 米重/kgm	产品图例
YLJ19003B T=1.26mm 0.680kg/m YLJ19003BA T=1.25mm 0.677kg/m YLJ19003BH T=1.80mm 0.883kg/m YLJ19003BT T=1.40mm 0.724kg/m		YLJ19003C T=1.20mm 0.900kg/m YLJ19003CT T=1.40mm 1.029kg/m		YLJ19003DT T=1.40mm 0.709kg/m	
YLJ19003EH T=1.60mm 0.904kg/m		YLJ19003GT T=1.40mm 1.237kg/m		YLJ19033 T=1.20mm 0.823kg/m	
YLJ19033A T=1.40mm 1.004kg/m		YLJ19033D T=1.40mm 1.089kg/m		YLJ19004 T=1.26mm 0.601kg/m YLJ19004P* T=(1.20mm) 0.558kg/m YLJ19004T T=1.40mm 0.649kg/m YLJ19004H T=1.60mm 0.722kg/m	
YLJ19004A T=1.20mm 0.600kg/m YLJ19004AT T=1.40mm 0.680kg/m YLJ19004BH T=2.00mm 0.880kg/m		YLJ19004BT T=1.40mm 0.687kg/m		YLJ19004TZK T=1.40mm 0.605kg/m YLJ19004ZK T=1.20mm 0.548kg/m	
YLJ19004HT T=1.35mm 0.631kg/m		YLJ19004QZK T=1.40mm 0.591kg/m		YLJ19005 T=1.26mm 0.773kg/m YLJ19005P* T=(1.20mm) 0.724kg/m YLJ19005T T=1.40mm 0.849kg/m YLJ19005H T=1.60mm 0.969kg/m	

注：图中所示为标注厚度的理论重量，实际重量以过磅时的重量为准。

90系列推拉窗型材图

Aluminium Profiles for Series 90 Sliding Window

永利坚铝材 YONGLIJIAN



型号厚度 米重/kgm	产品图例	型号厚度 米重/kgm	产品图例	型号厚度 米重/kgm	产品图例
YLJ19005AH T=2.00mm 1.140kg/m		YLJ19005HT T=1.35mm 0.825kg/m		YLJ19005ZK T=1.20mm 0.708kg/m YLJ19005TZK T=1.40mm 0.792kg/m YLJ19005HZK T=1.60mm 0.883kg/m	
YLJ19005QZK T=1.40mm 0.750kg/m		YLJ19006 T=1.20mm 0.708kg/m YLJ19006P* T=1.20mm 0.670kg/m YLJ19006T T=1.40mm 0.853kg/m YLJ19006H T=1.60mm 0.930kg/m		YLJ19006BT T=1.40mm 0.714kg/m	
YLJ19006CT T=1.40mm 0.716kg/m		YLJ19006HT T=1.80mm 0.984kg/m		YLJ19006ZK T=1.20mm 0.673kg/m YLJ19006TZK T=1.40mm 0.768kg/m YLJ19006HZK T=1.60mm 0.869kg/m	
YLJ19006QZK T=1.40mm 0.744kg/m		YLJ19006DT T=1.40mm 0.684kg/m		YLJ19006CT T=1.40mm 0.716kg/m	
YLJ19007 T=1.20mm 0.746kg/m YLJ19007H T=1.60mm 0.950kg/m YLJ19007T T=1.40mm 0.856kg/m YLJ19007P* T=(1.20mm) 0.672kg/m		YLJ19007HT T=1.80mm 0.970kg/m		YLJ19007HZK T=1.60mm 0.880kg/m	

注：图中所示为标注厚度的理论重量，实际重量以过磅时的重量为准。



型号厚度 米重/kgm	产品图例	型号厚度 米重/kgm	产品图例	型号厚度 米重/kgm	产品图例
YLJ19007TZK T=1.40mm 0.802kg/m YLJ19007ZK T=1.20mm 0.718kg/m		YLJ19007QZK T=1.40mm 0.760kg/m		YLJ19076 T=1.60mm 1.062kg/m	
YLJ19076AT T=1.40mm 0.893kg/m		YLJ19076T T=1.40mm 0.949kg/m		YLJ19082 T=1.60mm 1.111kg/m	
YLJ19083 T=1.60mm 0.847kg/m		YLJ19088 T=1.00mm 0.157kg/m		YLJ19089 T=1.20mm 0.925kg/m	
YLJ19089WP T=1.00mm 0.444kg/m		YLJ19092A T=1.40mm 0.659kg/m		YLJ19095 T=1.20mm 0.902kg/m	
YLJ19008 T=1.26mm 0.461kg/m YLJ19008H T=1.60mm 0.529kg/m YLJ19008T T=1.40mm 0.486kg/m YLJ19008P T=0.90mm 0.365kg/m		YLJ19070T T=1.35mm 0.804kg/m		YLJ19011 T=1.20mm 0.430kg/m	

90系列推拉窗型材图

Aluminium Profiles for Series 90 Sliding Window

永利坚铝材 YONGLIJIAN



型号厚度 米重/kgm	产品图例	型号厚度 米重/kgm	产品图例	型号厚度 米重/kgm	产品图例
YLJ19010B T=1.10mm 0.825kg/m		YLJ19092T T=1.40mm 0.740kg/m		YLJ19013T T=1.40mm 1.107kg/m	
YLJ190127 T=1.20mm 1.155kg/m		YLJ19047 T=1.20mm 0.268kg/m		YLJ19047A T=1.10mm 0.140kg/m	
YLJ19011A T=1.30mm 0.345kg/m		YLJ19039 T=1.10mm 0.197kg/m		YLJ19047BP T=1.00mm 0.316kg/m	
YLJ19122 T=1.70mm 0.368kg/m		YLJ19023 T=1.20mm 0.269kg/m		YLJ19009A T=1.10mm 0.271kg/m	
YLJ19009C T=1.10mm 0.238kg/m		YLJ19009CE T=1.10mm 0.187kg/m		YLJ19009B T=1.00mm 0.362kg/m	



型号厚度 米重/kgm	产品图例	型号厚度 米重/kgm	产品图例	型号厚度 米重/kgm	产品图例
YLJ19009CK T=1.00mm 0.165kg/m		YLJ19009M T=1.10mm 0.268kg/m		YLJ19009V T=1.00mm 0.375kg/m	
YLJ19009U T=1.00mm 0.322kg/m		YLJ19009F T=1.10mm 0.264kg/m		YLJ19009MA T=1.50mm 0.261kg/m	
YLJ19009N T=1.10mm 0.208kg/m		YLJ19009Z T=1.00mm 0.369kg/m		YLJ19009W T=1.00mm 0.275kg/m	
YLJ19009RA T=0.90mm 0.314kg/m		YLJ19009S T=1.10mm 0.417kg/m		YLJ19009WA T=1.00mm 0.387kg/m	

注：图中所示为标注厚度的理论重量，实际重量以过磅时的重量为准。

788系列推拉窗结构图

Structure Diagram of Series 788 Sliding Window

永利坚铝材 YONGLIJIAN

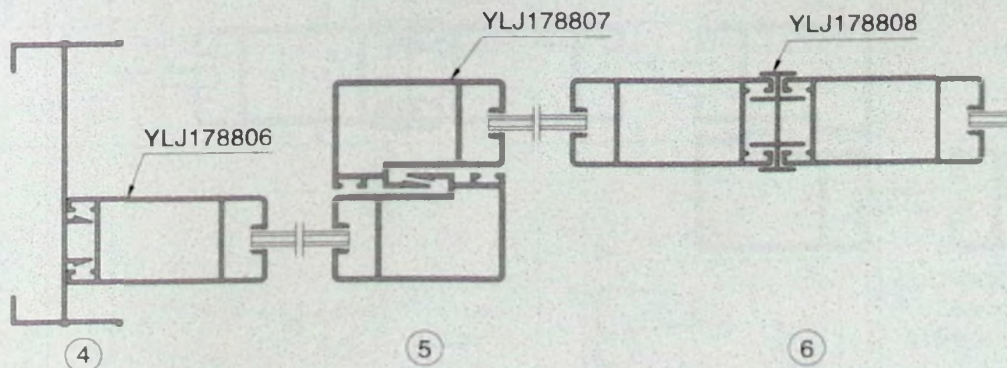
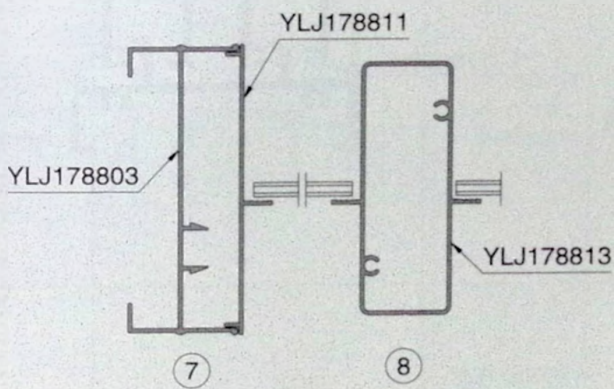
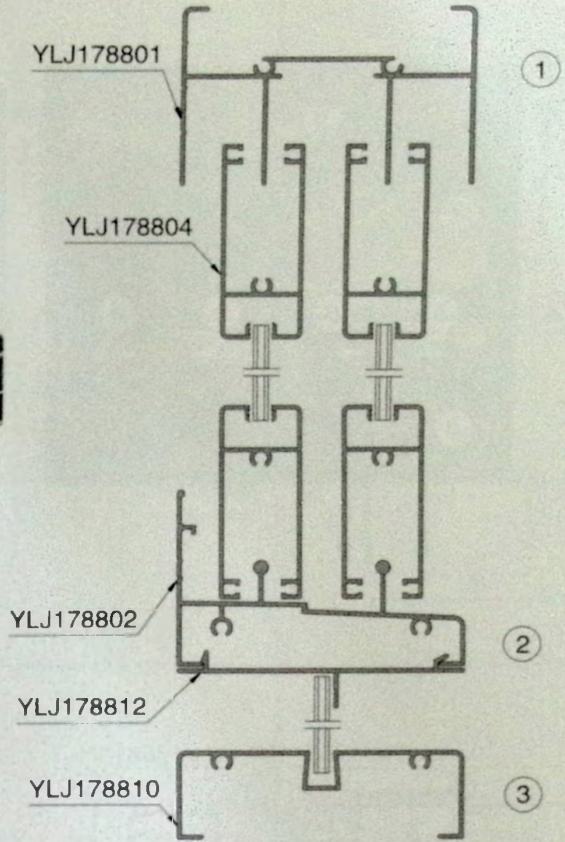
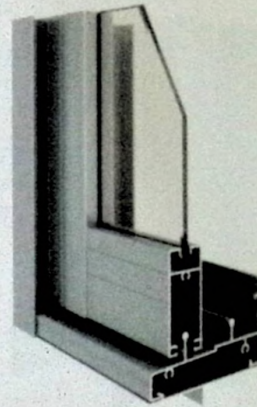
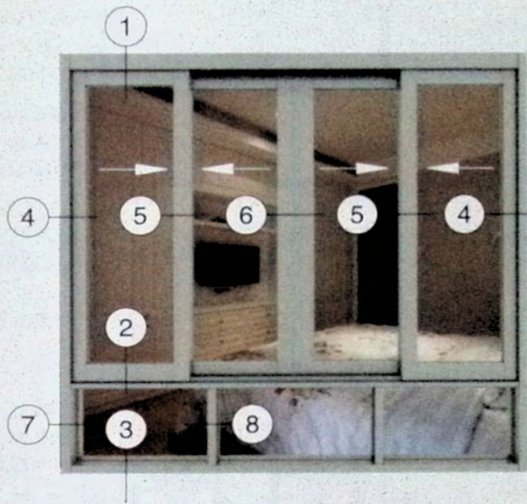

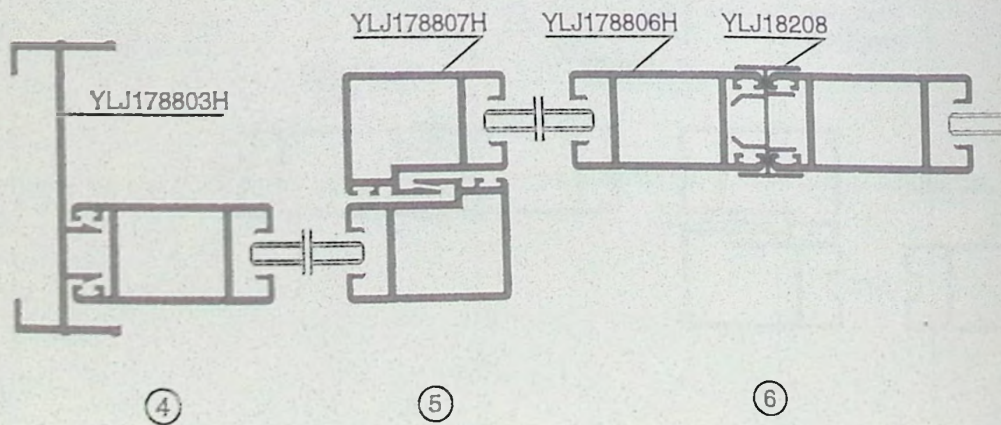
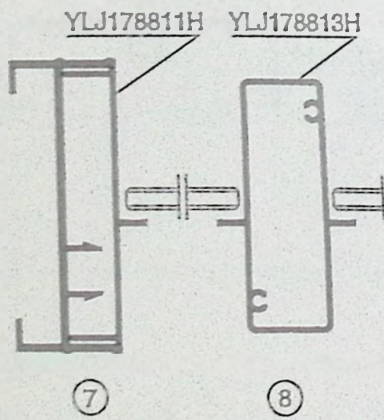
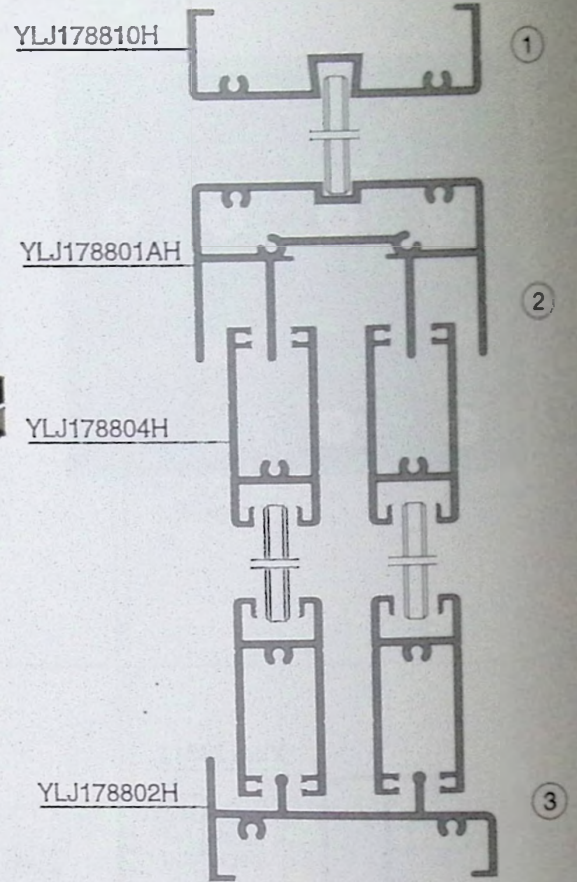
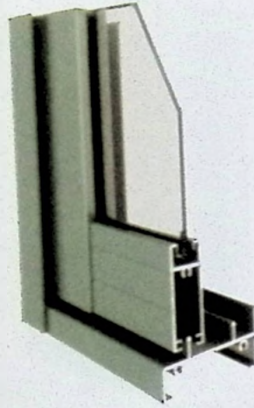
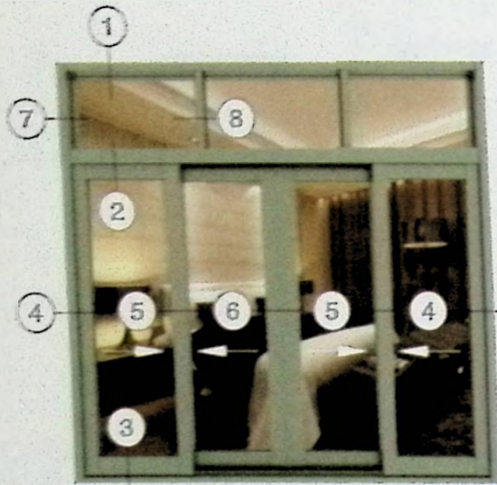

788系列推拉窗型材图

Aluminium Profiles for Series 788 Sliding Window

永利坚铝材 YONGLIJIAN



型号厚度 米重/kgm	产品图例	型号厚度 米重/kgm	产品图例	型号厚度 米重/kgm	产品图例
YLJ178801 T=1.20mm 0.836kg/m YLJ178801T T=1.40mm 1.008kg/m YLJ178801P* T=(1.20)mm 0.850kg/m		YLJ178801A T=1.20mm 1.111kg/m YLJ178801AT T=1.40mm 1.342kg/m YLJ178801AP* T=(1.20)mm 1.125kg/m		YLJ178801AH T=2.00mm 1.892kg/m	
YLJ178801B T=1.20mm 0.764kg/m YLJ178801BP* T=(1.20)mm 0.729kg/m		YLJ178801CP* T=(1.20)mm 1.067kg/m		YLJ178801H T=2.00mm 1.385kg/m	
YLJ178801N T=1.80mm 1.288kg/m		YLJ178801R T=1.10mm 1.018kg/m		YLJ178801RA T=1.10mm 1.362kg/m	
YLJ178802 T=1.20mm 0.676kg/m		YLJ178802A T=1.20mm 0.628kg/m YLJ178802AP* T=1.20mm 0.635kg/m		YLJ178802AB T=1.20mm 0.918kg/m	
YLJ178802B T=1.20mm 0.714kg/m YLJ178802BP* T=(1.20)mm 0.698kg/m		YLJ178802C* T=1.20mm 0.789kg/m		YLJ178802D* T=(1.20)mm 0.884kg/m	

注：图中所示为标注厚度的理论重量，实际重量以过磅时的重量为准。



型号厚度 米重/kgm	产品图例	型号厚度 米重/kgm	产品图例	型号厚度 米重/kgm	产品图例
YLJ178802DP* T=1.20mm 0.664kg/m		YLJ178802F T=1.20mm 0.888kg/m		YLJ178802FB T=1.20mm 0.911kg/m	
YLJ178802FC T=1.50mm 0.506kg/m		YLJ178802FQ T=1.20mm 1.155kg/m		YLJ178802H T=2.00mm 0.976kg/m	
YLJ178802HC T=1.20mm 0.982kg/m		YLJ178802HD T=1.20mm 0.676kg/m		YLJ178802N T=1.80mm 0.919kg/m	
YLJ178802P* T=(1.20)mm 0.681kg/m		YLJ178802T T=1.40mm 0.718kg/m		YLJ178802TA T=1.40mm 1.070kg/m	
YLJ178802TC T=1.40mm 0.998kg/m		YLJ178802W T=1.40mm 0.827kg/m		YLJ178802WZ T=1.20mm 0.701kg/m	



型号厚度 米重/kgm	产品图例	型号厚度 米重/kgm	产品图例	型号厚度 米重/kgm	产品图例
YLJ178802R T=1.10mm 0.805kg/m		YLJ178803 T=1.20mm 0.535kg/m YLJ178803P* T=(1.20)mm 0.533kg/m		YLJ178803A T=1.20mm 0.553kg/m YLJ178803AP* T=(1.20)mm 0.551kg/m	
YLJ178803H T=2.00mm 0.898kg/m		YLJ178803T T=1.40mm 0.650kg/m		YLJ178803C T=1.20mm 0.606kg/m	
YLJ178803E T=1.20mm 0.852kg/m		YLJ178803DP* T=(1.20)mm 0.887kg/m		YLJ178803N T=1.80mm 0.832kg/m	
YLJ178803WZ T=1.20mm 0.525kg/m		YLJ178803R T=1.10mm 0.691kg/m		YLJ178803RA T=1.10mm 0.691kg/m	
YLJ178804* T=1.20mm 0.520kg/m YLJ178804P* T=1.20mm 0.536kg/m		YLJ178804BP* T=(1.20)mm 0.521kg/m		YLJ178804D* T=1.20mm 0.503kg/m	

注：图中所示为标注厚度的理论重量，实际重量以过磅时的重量为准。



型号厚度 米重/kgm	产品图例	型号厚度 米重/kgm	产品图例	型号厚度 米重/kgm	产品图例
YLJ178804T T=1.40mm 0.621kg/m		YLJ178804CP* T=(1.20)mm 0.517kg/m		YLJ178804EP* T=(1.20)mm 0.482kg/m	
YLJ178804H T=2.00mm 0.879kg/m		YLJ178804FP* T=(1.20)mm 0.540kg/m		YLJ178804N T=1.60mm 0.737kg/m	
YLJ178804KT T=1.40mm 0.650kg/m		YLJ178804PA T=1.40mm 0.656kg/m		YLJ178804ZK T=1.20mm 0.451kg/m	
YLJ178804HZK T=2.00mm 0.807kg/m		YLJ178804PZK* T=(1.20)mm 0.472kg/m		YLJ178804Q* T=(1.20)mm 0.520kg/m	
YLJ178805* T=(1.20)mm 0.646kg/m		YLJ178805E T=1.20mm 0.536kg/m		YLJ178805F T=1.20mm 0.644kg/m	

788系列推拉窗型材图

Aluminium Profiles for Series 788 Sliding Window

永利坚铝材 YONGLIJIAN



型号厚度 米重/kgm	产品图例	型号厚度 米重/kgm	产品图例	型号厚度 米重/kgm	产品图例
YLJ178805N T=1.60mm 0.903kg/m		YLJ178805Q* T=(1.20)mm 0.639kg/m		YLJ178806 T=1.20mm 0.574kg/m	
YLJ178806A T=1.20mm 0.625kg/m		YLJ178806AP* T=(1.20)mm 0.618kg/m		YLJ178806BP* T=(1.20)mm 0.618kg/m	
YLJ178806CP* T=(1.20)mm 0.565kg/m		YLJ178806DP* T=(1.20)mm 0.555kg/m		YLJ178806H T=2.00mm 1.008kg/m	
YLJ178806N T=1.60mm 0.818kg/m		YLJ178806P* T=(1.20)mm 0.574kg/m		YLJ178806PA T=1.40mm 0.723kg/m	
YLJ178806KT T=1.40mm 0.753kg/m		YLJ178806PZK* T=(1.20)mm 0.521kg/m		YLJ178806HZK T=2.00mm 0.947kg/m	

注：图中所示为标注厚度的理论重量，实际重量以过磅时的重量为准。



型号厚度 米重/kgm	产品图例	型号厚度 米重/kgm	产品图例	型号厚度 米重/kgm	产品图例
YLJ178806Q* T=1.20mm 0.574kg/m		YLJ178806T T=1.40mm 0.728kg/m		YLJ178806W T=1.15mm 0.566kg/m	
YLJ178806WZ T=1.15mm 0.570kg/m		YLJ178807 T=1.20mm 0.597kg/m		YLJ178807BP* T=(1.20)mm 0.565kg/m	
YLJ178807DP* T=(1.20)mm 0.582kg/m		YLJ178807E T=1.20mm 0.801kg/m		YLJ178807H T=2.00mm 0.976kg/m	
YLJ178807HZK T=2.00mm 0.904kg/m		YLJ178807KT T=1.40mm 0.710kg/m		YLJ178807P* T=1.20mm 0.586kg/m	
YLJ178807PA T=1.40mm 0.714kg/m		YLJ178807T T=1.40mm 0.687kg/m		YLJ178807N T=1.60mm 0.811kg/m	

注：图中所示为标注厚度的理论重量，实际重量以过磅时的重量为准。

788系列推拉窗型材图

Aluminium Profiles for Series 788 Sliding Window

永利坚铝材 YONGLIJIAN



型号厚度 米重/kgm	产品图例	型号厚度 米重/kgm	产品图例	型号厚度 米重/kgm	产品图例
YLJ178807PZK* T=1.20mm 0.532kg/m		YLJ178807Q* T=1.20mm 0.591kg/m		YLJ178807W T=1.15mm 0.575kg/m	
YLJ178807WZ T=1.15mm 0.577kg/m		YLJ178808 T=1.00mm 0.255kg/m		YLJ178808AP T=1.00mm 0.265kg/m	
YLJ178808C T=1.00mm 0.127kg/m		YLJ178808T T=1.00mm 0.270kg/m		YLJ178809 T=0.80mm 0.258kg/m	
YLJ178809A T=0.80mm 0.111kg/m		YLJ178810 T=1.20mm 0.547kg/m		YLJ178810AP* T=1.20mm 0.540kg/m	
YLJ178810H T=2.00mm 0.929kg/m		YLJ178810T T=1.40mm 0.661kg/m		YLJ178810ZK T=1.20mm 0.578kg/m	

注：图中所示为标注厚度的理论重量，实际重量以过磅时的重量为准。



型号厚度 米重/kgm	产品图例	型号厚度 米重/kgm	产品图例	型号厚度 米重/kgm	产品图例
YLJ178810R T=1.00mm 0.596kg/m		YLJ178811 T=1.10mm 0.292kg/m		YLJ178811H T=1.40mm 0.430kg/m	
YLJ178811P T=1.00mm 0.299kg/m		YLJ178812 T=1.10mm 0.320kg/m		YLJ178812ZK T=1.00mm 0.356kg/m	
YLJ178813* T=1.20mm 0.666kg/m		YLJ178813B* T=(1.20)mm 0.723kg/m		YLJ178813H T=1.40mm 0.834kg/m	
YLJ178813P* T=1.20mm 0.698kg/m		YLJ178813HA T=1.20mm 0.809kg/m		YLJ178813M T=1.00mm 0.617kg/m	
YLJ178813ZK T=1.20mm 0.816kg/m		YLJ178814 T=1.20mm 0.921kg/m		YLJ178814A T=1.20mm 1.218kg/m	

788系列推拉窗型材图

Aluminium Profiles for Series 788 Sliding Window

永利坚铝材 YONGLIJIAN



型号厚度 米重/kgm	产品图例	型号厚度 米重/kgm	产品图例	型号厚度 米重/kgm	产品图例
YLJ178814F T=1.10mm 0.930kg/m		YLJ178816 T=1.20mm 1.014kg/m		YLJ178815 T=1.10mm 0.307kg/m	
YLJ178817 T=1.20mm 0.674kg/m		YLJ178821 T=1.10mm 0.213kg/m		YLJ178824 T=1.20mm 0.707kg/m	
YLJ178824P* T=(1.20)mm 0.637kg/m		YLJ178830 T=0.80mm 0.414kg/m			

注：图中所示为标注厚度的理论重量，实际重量以过磅时的重量为准。

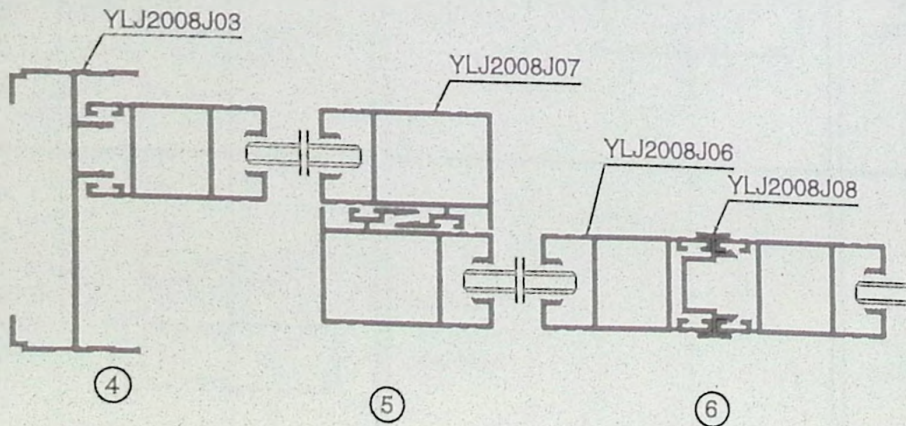
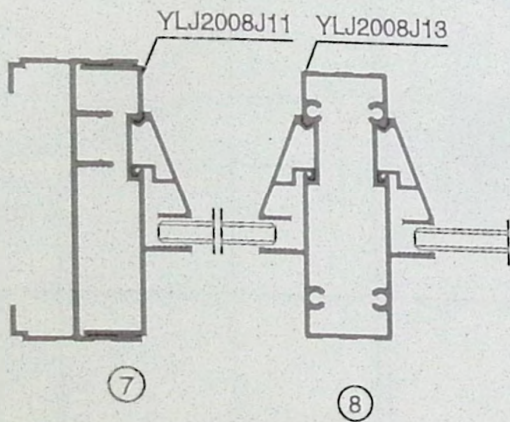
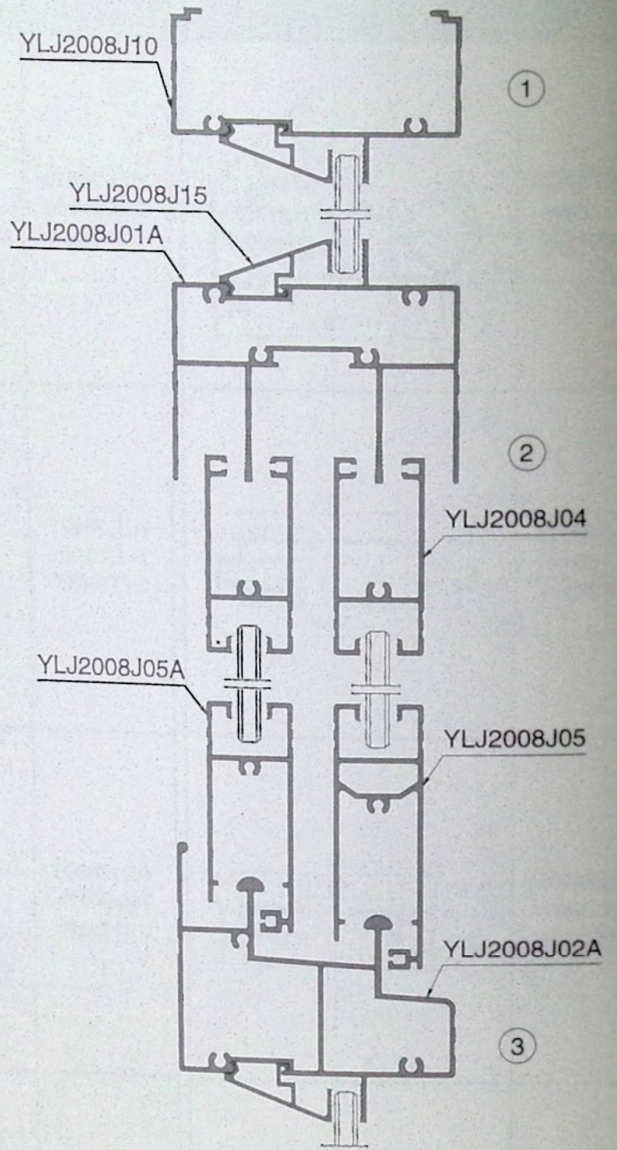
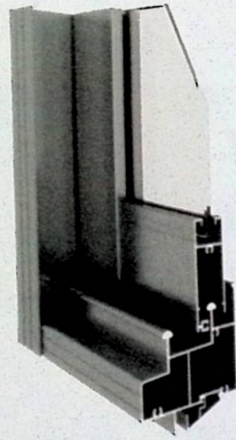
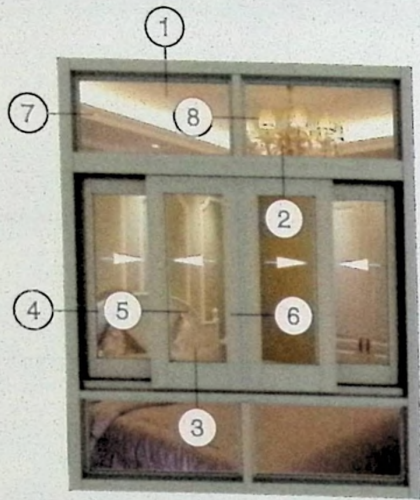

2008J系列推拉窗(中空)结构图
Structure Diagram of Series 2008J Sliding Window(Hollow)

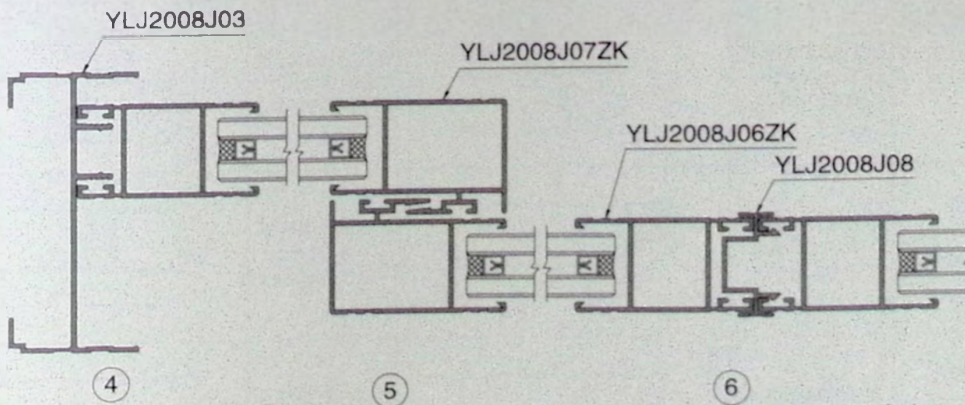
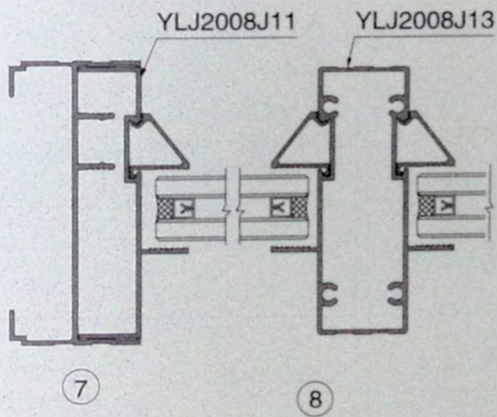
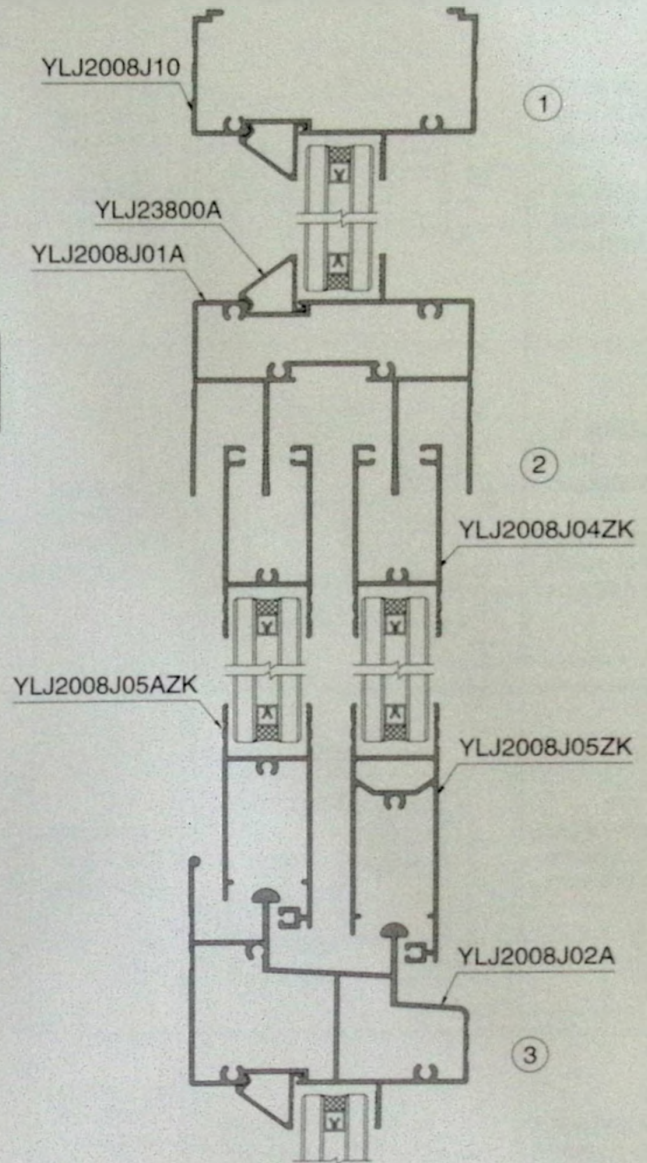
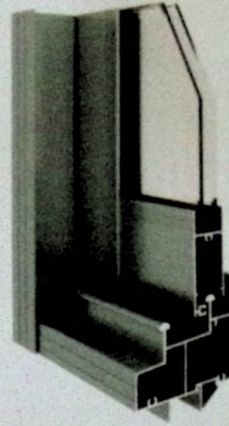
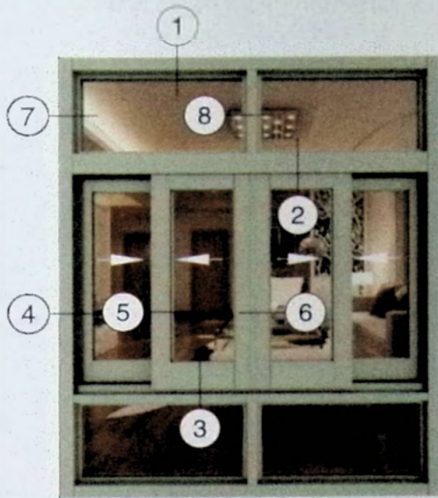



型号厚度 米重/kgm	产品图例	型号厚度 米重/kgm	产品图例	型号厚度 米重/kgm	产品图例
YLJ2008J01 T=1.20mm 0.898kg/m YLJ2008J01T T=1.40mm 0.986kg/m		YLJ2008J01A T=1.20mm 1.290kg/m YLJ2008J01AT T=1.40mm 1.416kg/m		YLJ2008J02 T=1.20mm 1.209kg/m YLJ2008J02T T=1.40mm 1.344kg/m	
YLJ2008J02A T=1.20mm 1.302kg/m YLJ2008J02AT T=1.40mm 1.441kg/m		YLJ2008J02C T=1.20mm 0.976kg/m		YLJ2008J02D T=1.20mm 1.194kg/m	
YLJ2008J02E T=1.20mm 1.261kg/m		YLJ2008J02EA T=1.20mm 0.634kg/m		YLJ2008J02F T=1.40mm 0.753kg/m	
YLJ2008J03 T=1.20mm 0.620kg/m YLJ2008J03T T=1.40mm 0.701kg/m		YLJ2008J04 T=1.20mm 0.572kg/m YLJ2008J04T T=1.40mm 0.655kg/m		YLJ2008J04ZK T=1.20mm 0.517kg/m YLJ2008J04TZK T=1.40mm 0.575kg/m	
YLJ2008J05 T=1.20mm 0.729kg/m		YLJ2008J05A T=1.20mm 0.594kg/m		YLJ2008J05ZK T=1.20mm 0.683kg/m	
YLJ2008J05T T=1.40mm 0.873kg/m		YLJ2008J05AT T=1.40mm 0.700kg/m		YLJ2008J05TZK T=1.40mm 0.792kg/m	

2008J系列推拉窗型材图

Aluminium Profiles for Series 2008J Sliding Window

永利坚铝材 YONGLIJIAN



型号厚度 米重/kgm	产品图例	型号厚度 米重/kgm	产品图例	型号厚度 米重/kgm	产品图例
YLJ2008J05AZK T=1.20mm 0.534kg/m		YLJ2008J05E T=1.20mm 0.580kg/m		YLJ2008J05EA T=1.20mm 0.716kg/m	
YLJ2008J05ATZK T=1.40mm 0.620kg/m		YLJ2008J05QZK T=1.20mm 0.662kg/m		YLJ2008J06 T=1.20mm 0.604kg/m	
YLJ2008J05EZK T=1.20mm 0.524kg/m		YLJ2008J07 T=1.20mm 0.676kg/m		YLJ2008J06T T=1.40mm 0.674kg/m	
YLJ2008J06ZK T=1.20mm 0.550kg/m		YLJ2008J07T T=1.40mm 0.732kg/m		YLJ2008J07ZK T=1.20mm 0.611kg/m	
YLJ2008J06TZK T=1.40mm 0.611kg/m		YLJ2008J08A T=1.15mm 0.230kg/m		YLJ2008J09 T=1.20mm 0.610kg/m	
YLJ2008J08 T=1.15mm 0.240kg/m		YLJ2008J11 T=1.15mm 0.430kg/m		YLJ2008J09T T=1.40mm 0.780kg/m	
YLJ2008J10 T=1.20mm 0.620kg/m		YLJ2008J11T T=1.40mm 0.614kg/m		YLJ2008J12 T=1.20mm 1.000kg/m	
YLJ2008J10T T=1.40mm 0.705kg/m				YLJ2008J12T T=1.40mm 1.168kg/m	

注：图中所示为标注厚度的理论重量，实际重量以过磅时的重量为准。



型号厚度 米重/kgm	产品图例	型号厚度 米重/kgm	产品图例	型号厚度 米重/kgm	产品图例
YLJ2008J12AT T=1.40mm 1.332kg/m		YLJ2008J12BT T=1.40mm 1.332kg/m		YLJ2008J13 T=1.20mm 0.909kg/m	
				YLJ2008J13T T=1.40mm 0.993kg/m	
YLJ2008J14 T=0.90mm 0.330kg/m		YLJ2008J14A T=0.80mm 0.289kg/m		YLJ2008J15 T=0.90mm 0.158kg/m	氧化专用
				YLJ2008J15PT T=0.90mm 0.160kg/m	喷涂专用
YLJ2008J17 T=2.50mm 0.087kg/m		YLJ2008J18 T=1.15mm 0.351kg/m			

100系列推拉窗结构图

Structure Diagram of Series 100 Sliding Window

永利坚铝材 YONGLIJIAN

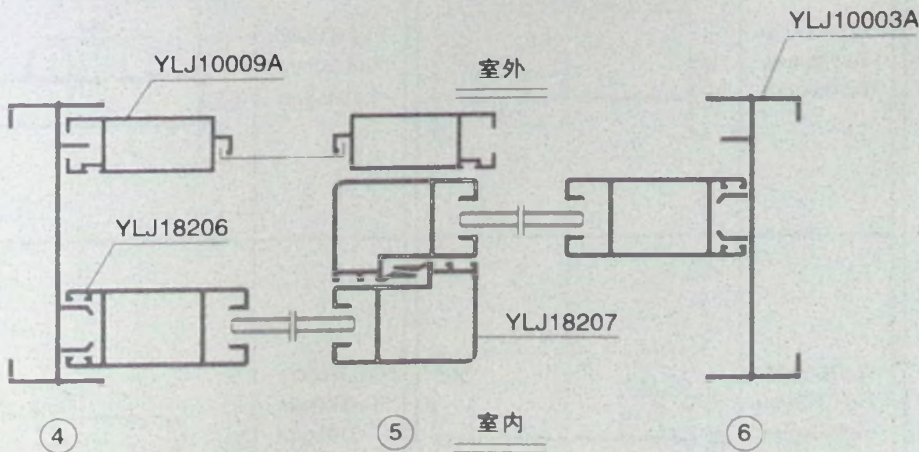
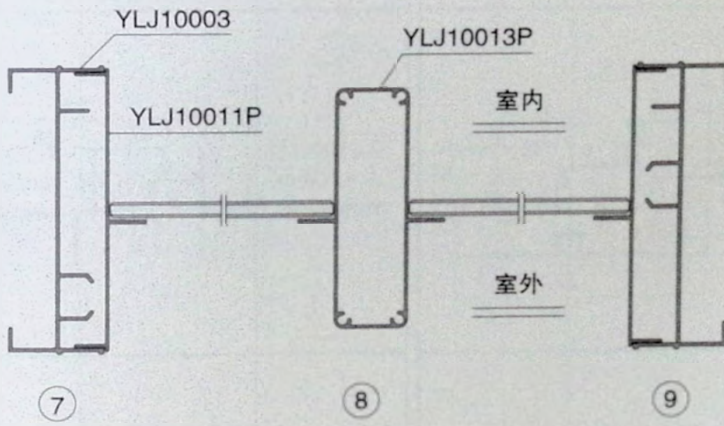
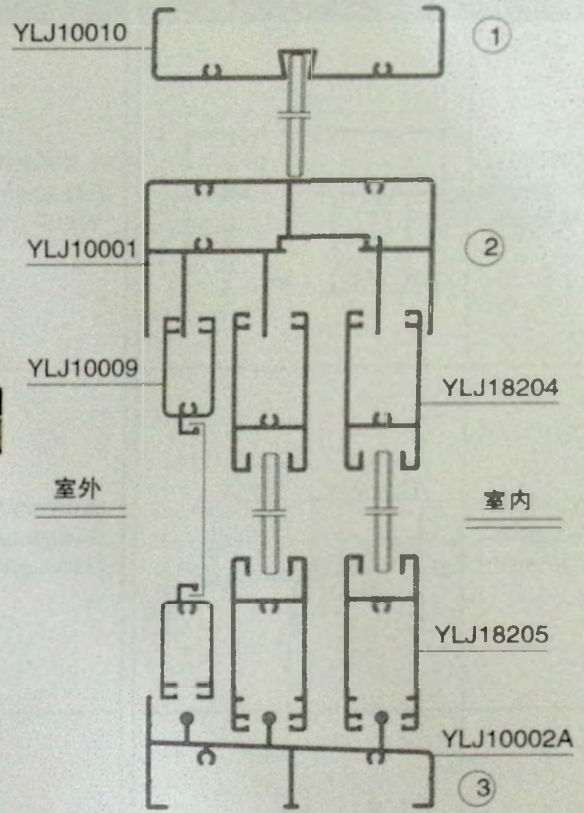
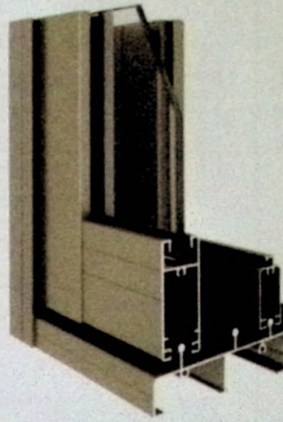
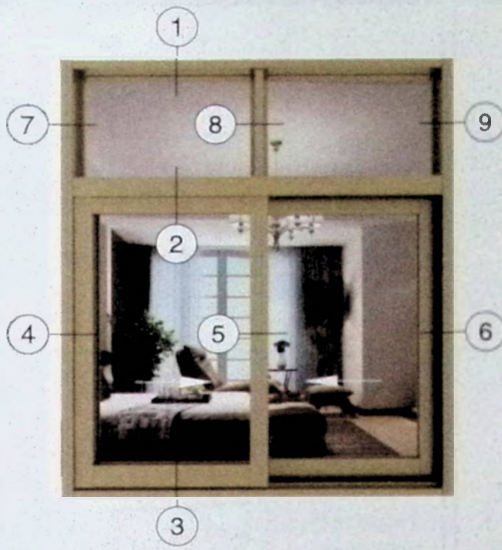



型号厚度 米重/kgm	产品图例	型号厚度 米重/kgm	产品图例	型号厚度 米重/kgm	产品图例
YLJ10001 T=1.20mm 1.460kg/m		YLJ10001B* T=(1.20mm) 0.923kg/m		YLJ10001G T=1.20mm 1.484kg/m	
YLJ10002 T=1.20mm 1.001kg/m		YLJ10002A T=1.20mm 0.886kg/m		YLJ10002E T=1.20mm 1.193kg/m	
YLJ10002XF T=1.20mm 1.408kg/m		YLJ10002XG T=1.40mm 1.636kg/m		YLJ10002F T=1.20mm 1.019kg/m	
YLJ10003 T=1.20mm 0.708kg/m		YLJ10003A T=1.20mm 0.708kg/m		YLJ10003B T=1.20mm 1.194kg/m	
YLJ10003AD* T=1.20mm 0.650kg/m		YLJ10003D* T=(1.20mm) 0.650kg/m		YLJ10009 T=0.90mm 0.319kg/m	

100系列推拉窗型材图

Aluminium Profiles for Series 100 Sliding Window

永利坚铝材 YONGLIJIAN



型号厚度 米重/kgm	产品图例	型号厚度 米重/kgm	产品图例	型号厚度 米重/kgm	产品图例
YLJ10018 T=0.90mm 0.427kg/m		YLJ10017 T=0.90mm 0.369kg/m		YLJ10019 T=0.90mm 0.393kg/m	
YLJ10009A T=0.90mm 0.397kg/m		YLJ10010 T=1.20mm 0.634kg/m		YLJ10010D* T=1.20mm 0.587kg/m	
YLJ10011P T=1.00mm 0.371kg/m		YLJ10013P* T=(1.20mm) 0.779kg/m		YLJ10014 T=1.20mm 0.579kg/m	

注：图中所示为标注厚度的理论重量，实际重量以过磅时的重量为准。

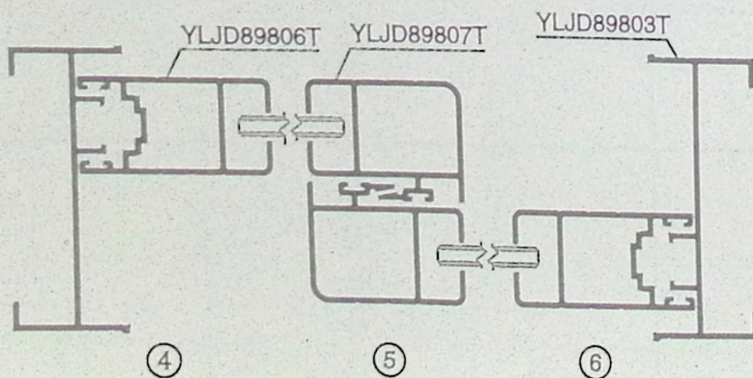
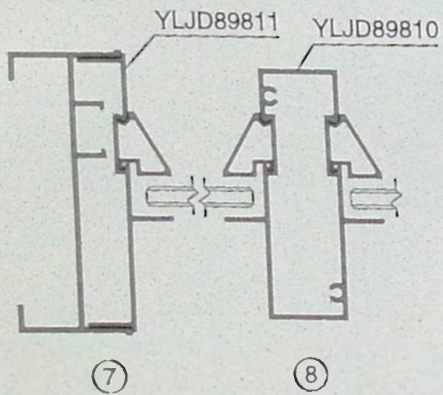
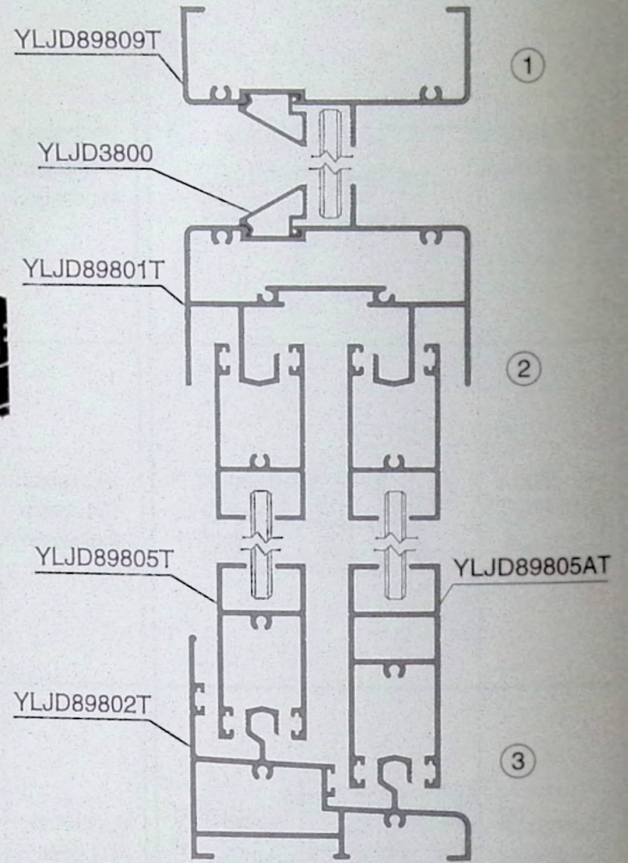
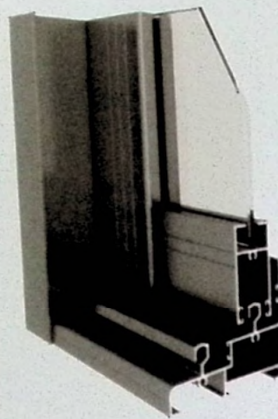
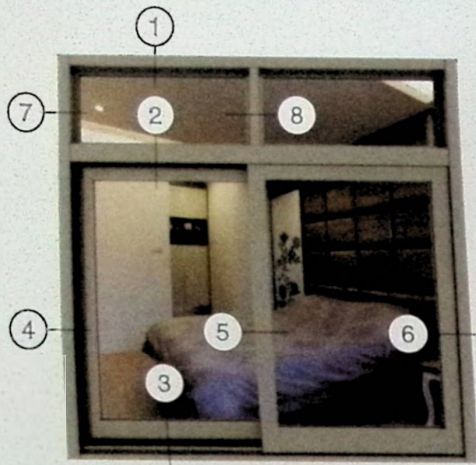

898系列推拉窗结构图

Structure Diagram of Series 898 Sliding Window

永利坚铝材 YONGLIJIAN

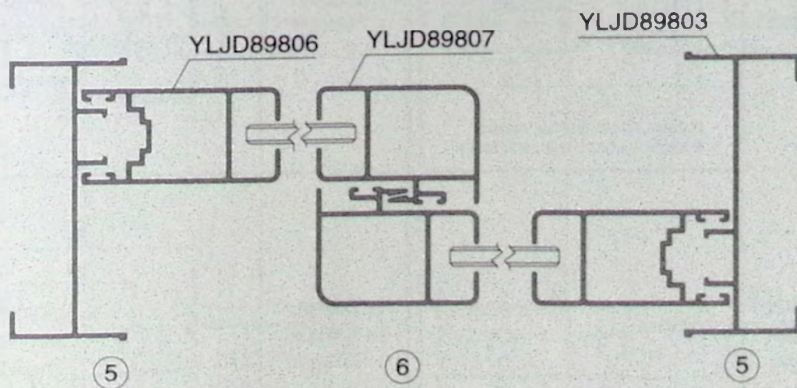
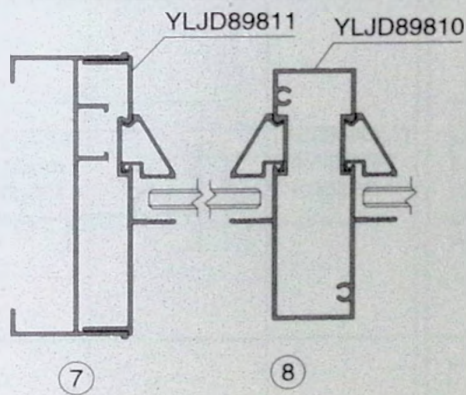
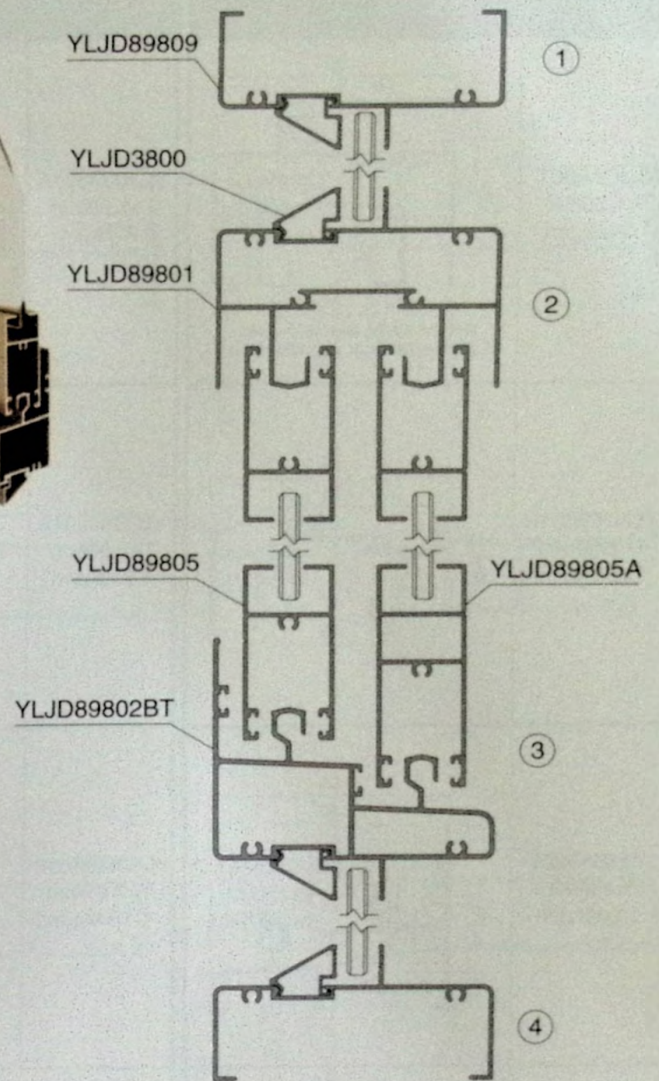
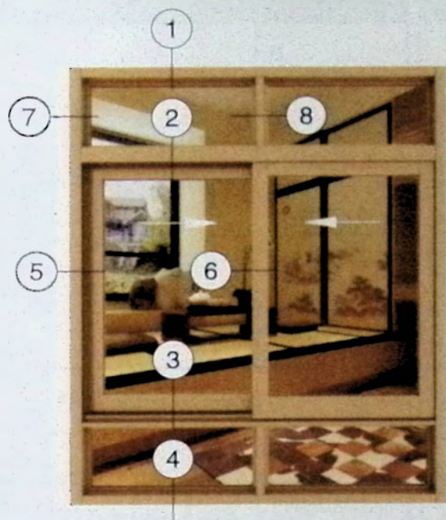



	产品图例		产品图例		产品图例
YLJD89801 T=1.20mm 1.345kg/m	<p>配压线YLJD3800 玻璃口宽13.00mm 配压线YLJD3800ZK 玻璃口宽21.00mm</p>	YLJD89801A T=1.20mm 0.877kg/m		YLJD89801AT T=1.40mm 1.012kg/m	
YLJD89801H T=2.00mm 1.381kg/m		YLJD89801S T=2.00mm 1.979kg/m	<p>配压线YLJD3800 玻璃口宽13.00mm 配压线YLJD3800ZK 玻璃口宽21.00mm</p>	YLJD89801T T=1.40mm 1.559kg/m	<p>配压线YLJD3800 玻璃口宽13.00mm 配压线YLJD3800ZK 玻璃口宽21.00mm</p>
YLJD89802 T=1.20mm 1.200kg/m		YLJD89802AH T=2.00mm 1.184kg/m		YLJD89802AT T=1.40mm 0.956kg/m	
YLJD89802BH T=2.00mm 1.940kg/m	<p>配压线YLJD3800 玻璃口宽13.00mm 配压线YLJD3800ZK 玻璃口宽21.00mm</p>	YLJD89802BT T=1.40mm 1.498kg/m	<p>配压线YLJD3800 玻璃口宽13.00mm 配压线YLJD3800ZK 玻璃口宽21.00mm</p>	YLJD89802H T=2.00mm 1.713kg/m	
YLJD89802LH T=2.00mm 1.041kg/m		YLJD89802LT T=1.40mm 0.824kg/m		YLJD89802T T=1.40mm 1.337kg/m	

898系列推拉窗型材图

Aluminium Profiles for Series 898 Sliding Window

永利坚铝材 YONGLIJIAN



型号厚度 米重/kgm	产品图例	型号厚度 米重/kgm	产品图例	型号厚度 米重/kgm	产品图例
YLJD89803 T=1.20mm 0.630kg/m		YLJD89803H T=2.00mm 0.964kg/m		YLJD89803T T=1.40mm 0.721kg/m	
YLJD89805 T=1.20mm 0.590kg/m		YLJD89805A T=1.20mm 0.770kg/m		YLJD89805AH T=2.00mm 1.128kg/m	
YLJD89805AT T=1.40mm 0.873kg/m		YLJD89805AZ T=1.20mm 0.735kg/m		YLJD89805AZH T=2.00mm 1.070kg/m	
YLJD89805AZT T=1.40mm 0.815kg/m		YLJD89805H T=2.00mm 0.838kg/m		YLJD89805T T=1.40mm 0.663kg/m	
YLJD89805Z T=1.20mm 0.555kg/m		YLJD89805ZH T=2.00mm 0.781kg/m		YLJD89805ZT T=1.40mm 0.621kg/m	

注：图中所示为标注厚度的理论重量，实际重量以过磅时的重量为准。



型号厚度 米重/kgm	产品图例	型号厚度 米重/kgm	产品图例	型号厚度 米重/kgm	产品图例
YLJD89806 T=1.20mm 0.710kg/m		YLJD89806AH T=2.00mm 1.255kg/m		YLJD89806BH T=2.00mm 1.763kg/m	
YLJD89806BZ T=2.00mm 1.706kg/m		YLJD89806KH T=2.00mm 1.198kg/m		YLJD89806T T=1.40mm 0.820kg/m	
YLJD89806Z T=1.20mm 0.665kg/m		YLJD89806ZT T=1.40mm 0.774kg/m		YLJD89807 T=1.20mm 0.681kg/m	
YLJD89807BH T=2.00mm 1.559kg/m		YLJD89807BZ T=2.00mm 1.504kg/m		YLJD89807H T=2.00mm 1.039kg/m	
YLJD89807T T=1.40mm 0.778kg/m		YLJD89807Z T=1.20mm 0.638kg/m		YLJD89807ZH T=2.00mm 0.986kg/m	

898系列推拉窗型材图

Aluminium Profiles for Series 898 Sliding Window

永利坚铝材 YONGLIJIAN



	产品图例		产品图例		产品图例
YLJD89807ZT T=1.40mm 0.731kg/m		YLJD89808 T=1.20mm 0.177kg/m		YLJD89809 T=1.20mm 0.631kg/m	 配压线YLJD3800 玻璃口宽13.00mm 配压线YLJD3800ZK 玻璃口宽21.00mm
YLJD89809H T=2.00mm 0.959kg/m	 配压线YLJD3800 玻璃口宽13.00mm 配压线YLJD3800ZK 玻璃口宽21.00mm	YLJD89809T T=1.40mm 0.727kg/m	 配压线YLJD3800 玻璃口宽13.00mm 配压线YLJD3800ZK 玻璃口宽21.00mm	YLJD89810 T=1.20mm 0.876kg/m	 配压线YLJD3800 玻璃口宽13.00mm 配压线YLJD3800ZK 玻璃口宽21.00mm
YLJD89811 T=1.20mm 0.447kg/m	 配压线YLJD3800 玻璃口宽13.00mm 配压线YLJD3800ZK 玻璃口宽21.00mm	YLJD89811A T=1.20mm 0.389kg/m	 配压线YLJD3800 玻璃口宽13.00mm 配压线YLJD3800ZK 玻璃口宽21.00mm	YLJD89813 T=1.20mm 0.727kg/m	
YLJD89873 T=1.20mm 0.454kg/m		YLJD89874 T=1.20mm 0.503kg/m		YLJD89875 T=1.20mm 0.465kg/m	

注：图中所示为标注厚度的理论重量，实际重量以过磅时的重量为准。

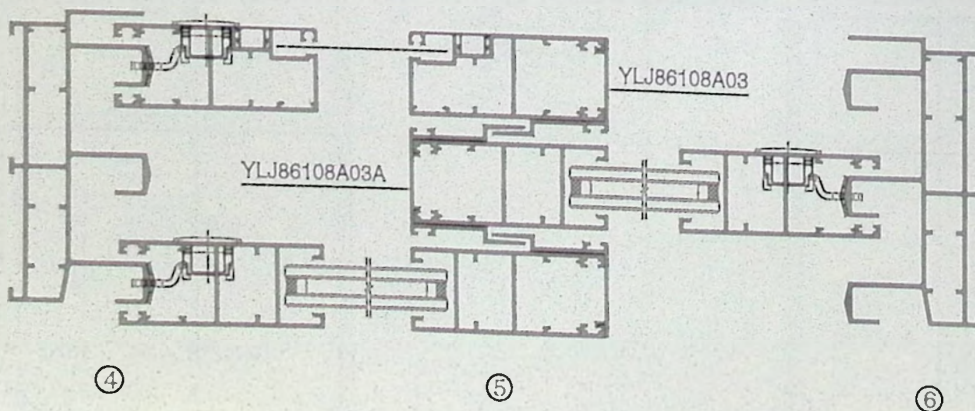
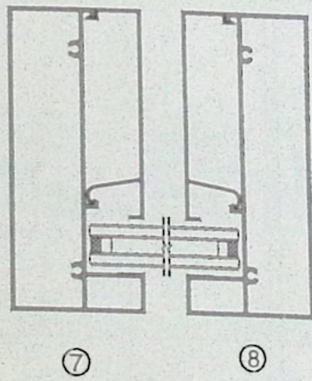
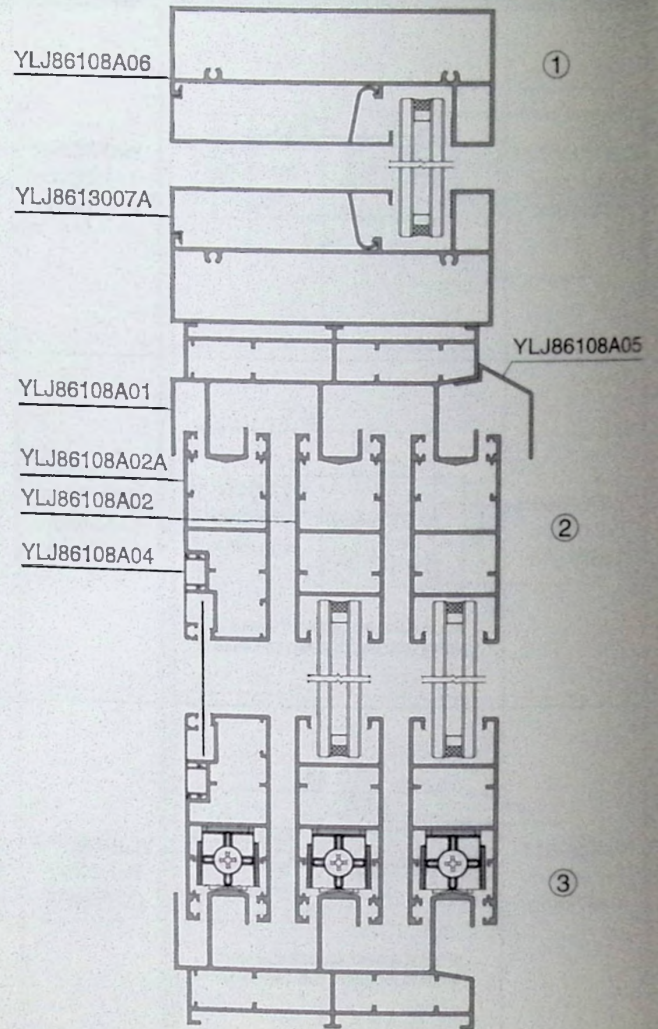
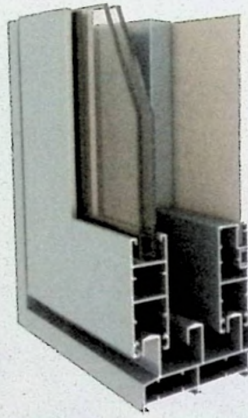
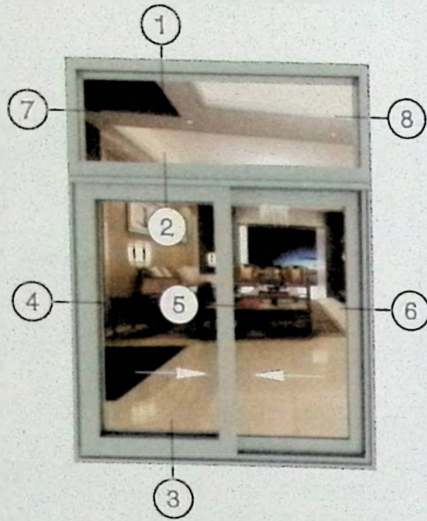

108A系列推拉窗型材图

Aluminium Profiles for Series 108A Sliding Window

永利坚铝材 YONGLIJIAN



	产品图例		产品图例		产品图例
YLJ86108A01 T=1.40mm 2.047kg/m		YLJ86108A02 T=1.40mm 1.029kg/m		YLJ86108A02A T=1.40mm 1.020kg/m	
YLJ86108A03 T=1.30mm 0.365kg/m		YLJ86108A03A T=1.30mm 0.601kg/m		YLJ86108A04 T=0.70mm 0.124kg/m	
YLJ86108A05 T=1.20mm 0.202kg/m		YLJ86108A06 T=1.40mm 1.470kg/m		YLJ8613007A T=1.20mm 0.425kg/m	
YLJ86108A08 T=1.00mm 0.275kg/m					

注：图中所示为标注厚度的理论重量，实际重量以过磅时的重量为准。

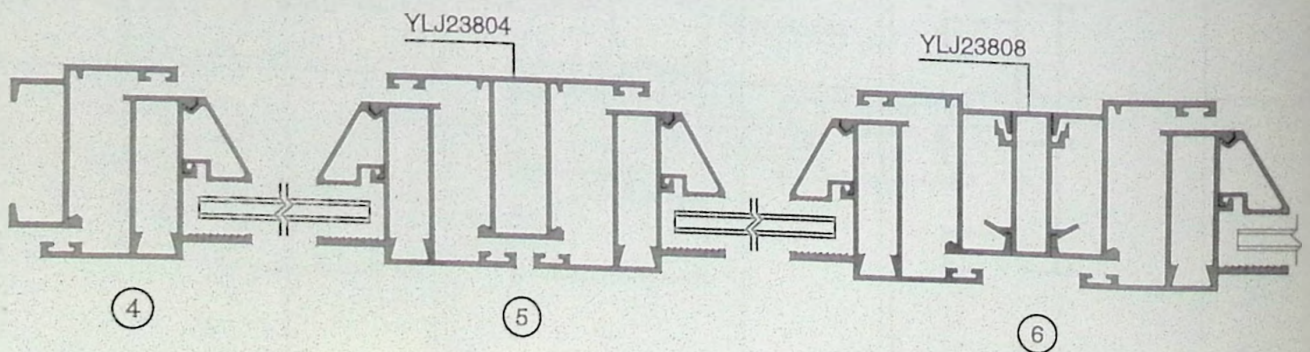
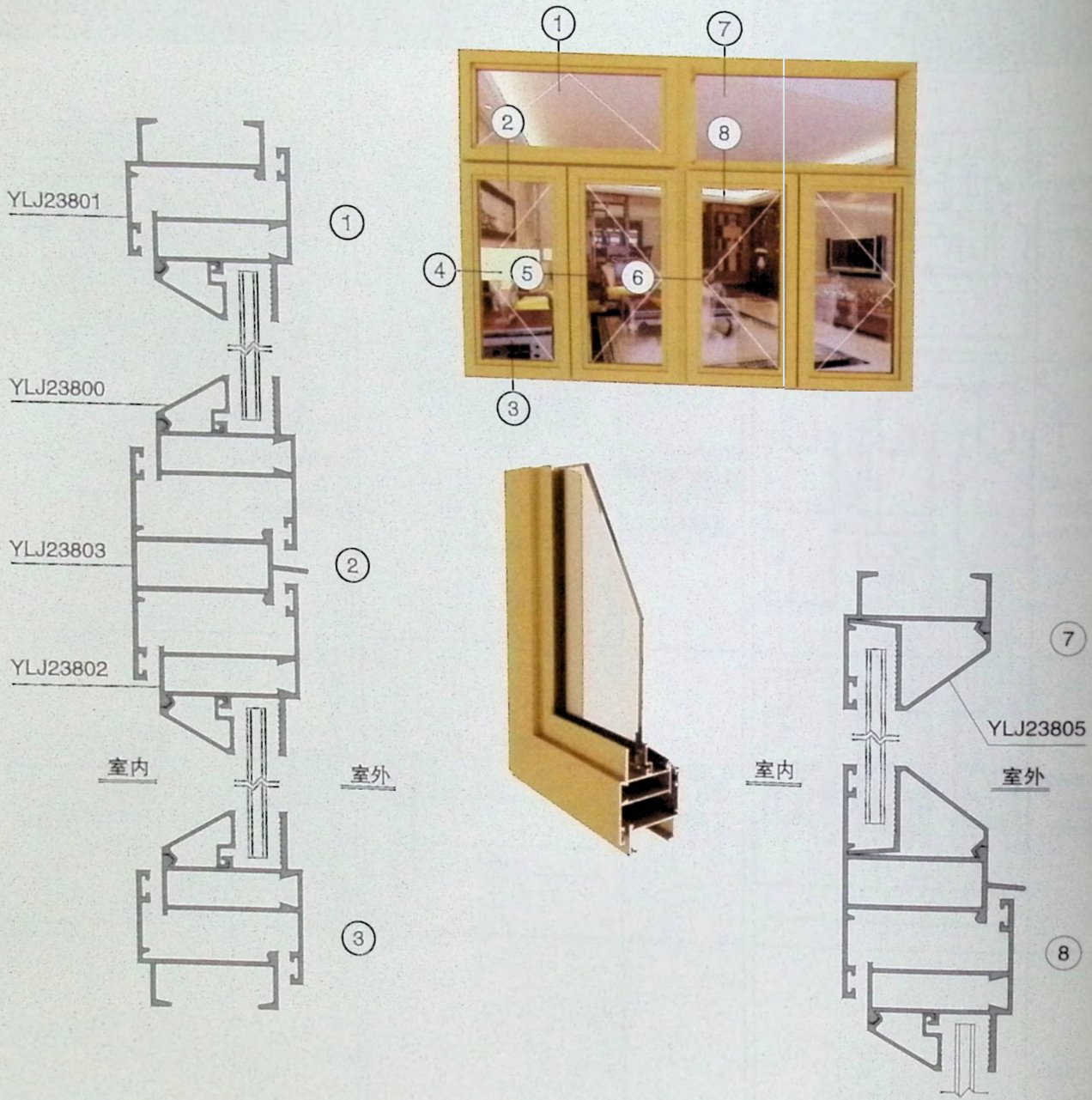

38系列平开窗(中空)结构图
Structure Diagram of Series 38 Casement Window(Hollow)

永利坚铝材 YONGLIJIAN

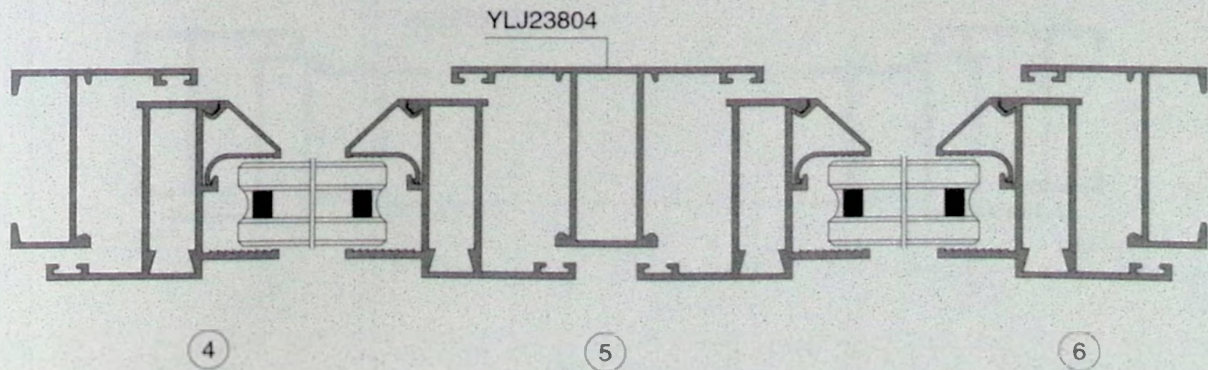
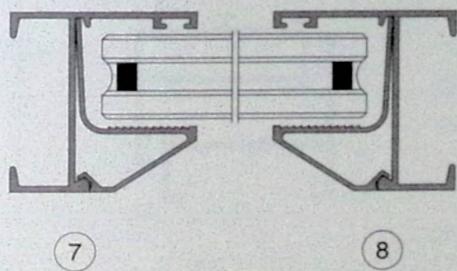
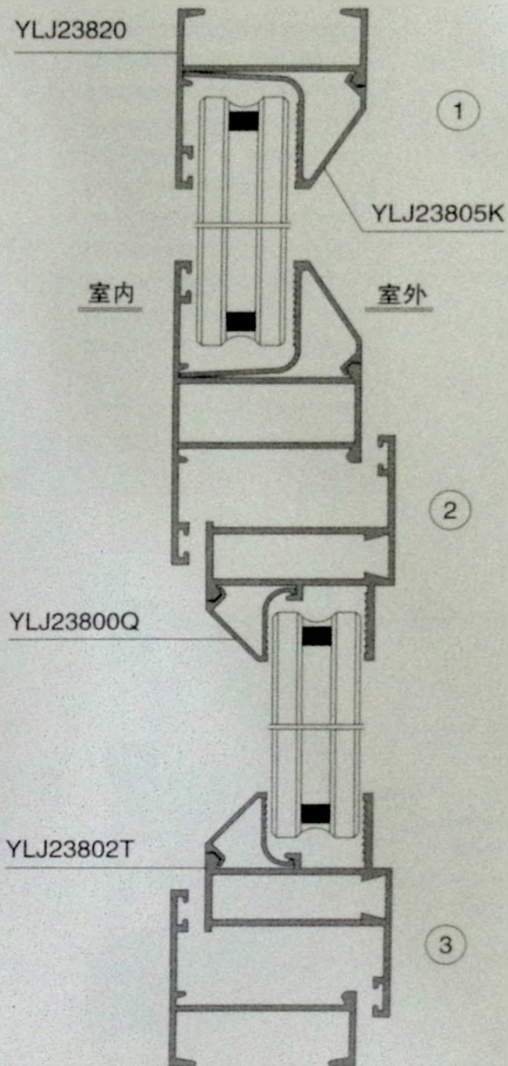
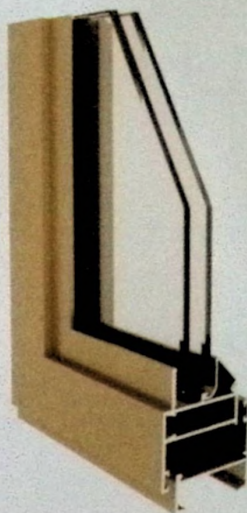
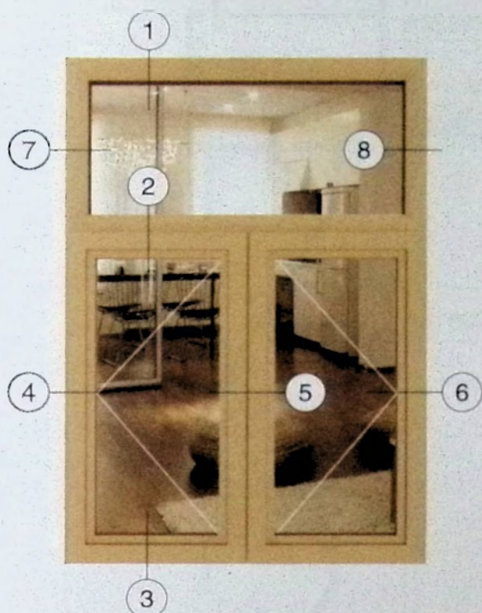

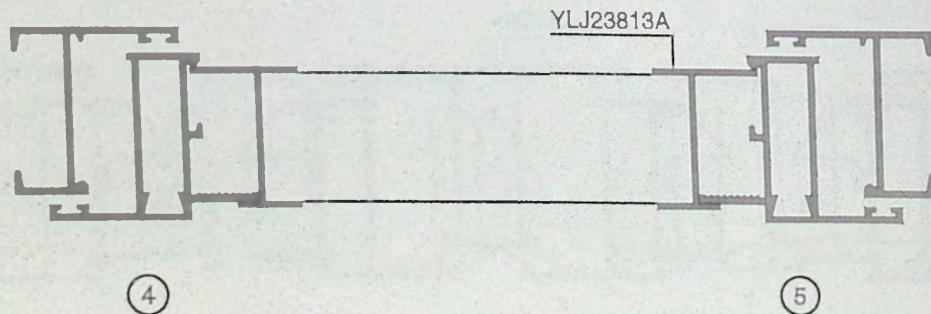
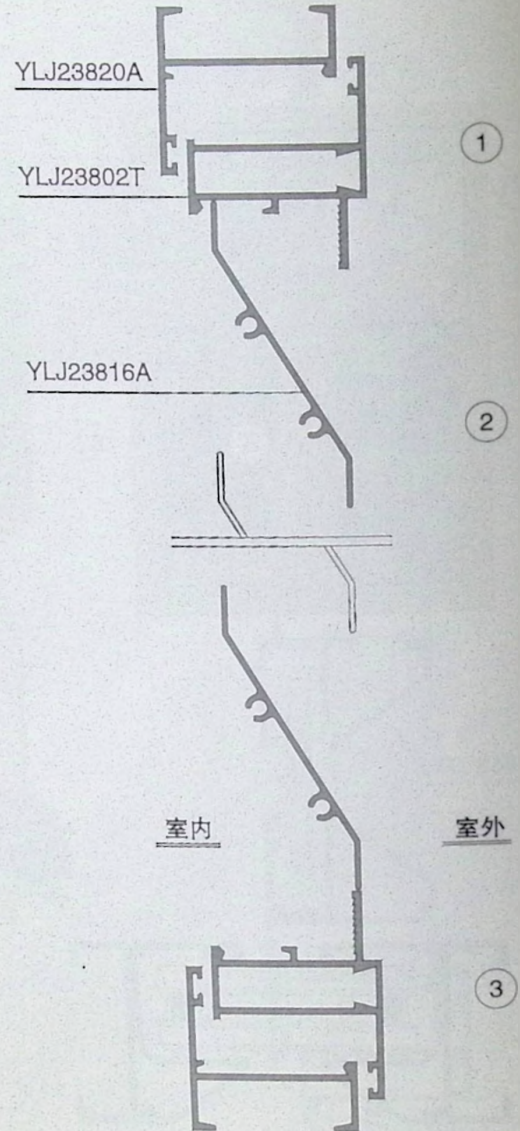
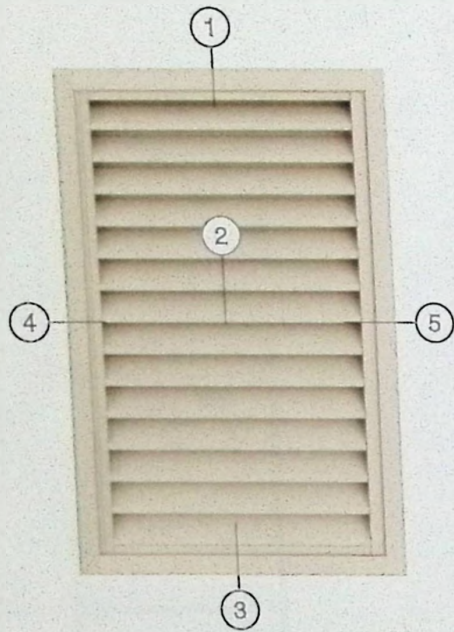

38系列平开窗型材图

Aluminium Profiles for Series 38 Casement Window

永利坚铝材 YONGLIJIAN



型号厚度 米重/kgm	产品图例	型号厚度 米重/kgm	产品图例	型号厚度 米重/kgm	产品图例
YLJ23800 T=0.90mm 0.128kg/m		YLJ23800A T=0.90mm 0.112kg/m		YLJ23800AB T=0.80mm 0.097kg/m	
YLJ23800F T=0.90mm 0.147kg/m		YLJ23800G T=0.90mm 0.112kg/m		YLJ23800H T=0.80mm 0.091kg/m	
YLJ23800J T=0.90mm 0.135kg/m		YLJ23800K T=0.90mm 0.130kg/m		YLJ23800L T=0.80mm 0.116kg/m	
YLJ23800N T=0.80mm 0.119kg/m		YLJ23800Q T=0.90mm 0.106kg/m		YLJ23800S T=0.80mm 0.112kg/m	
YLJ23800V T=0.80mm 0.099kg/m		YLJ23800W T=0.90mm 0.130kg/m		YLJ23800R T=0.80mm 0.095kg/m	

注：图中所示为标注厚度的理论重量，实际重量以过磅时的重量为准。



型号厚度 米重/kgm	产品图例	型号厚度 米重/kgm	产品图例	型号厚度 米重/kgm	产品图例
YLJ23800X T=1.00mm 0.140kg/m		YLJ23800Z T=0.90mm 0.107kg/m		YLJ23895 T=0.80mm 0.115kg/m	
YLJ23800U T=0.80mm 0.167kg/m		YLJ23800UA T=1.00mm 0.186kg/m		YLJ23800UB T=1.00mm 0.150kg/m	
YLJ23800UC T=0.90mm 0.179kg/m		YLJ23805 T=1.00mm 0.225kg/m		YLJ23805B T=1.06mm 0.193kg/m	
YLJ23805C T=1.00mm 0.253kg/m		YLJ23805K T=1.00mm 0.226kg/m		YLJ23805D T=1.00mm 0.175kg/m	
YLJ23893 T=1.10mm 0.221kg/m		YLJ23810 T=1.40mm 0.258kg/m		YLJ23810A T=1.40mm 0.304kg/m	

38系列平开窗型材图

Aluminium Profiles for Series 38 Casement Window

永利坚铝材 YONGLIJIAN



型号厚度 米重/kgm	产品图例	型号厚度 米重/kgm	产品图例	型号厚度 米重/kgm	产品图例
YLJ23810B T=1.00mm 0.242kg/m		YLJ23810C T=1.00mm 0.203kg/m		YLJ23810D T=0.80mm 0.164kg/m	
YLJ23810F T=1.00mm 0.160kg/m		YLJ23810P T=1.24mm 0.229kg/m		YLJ23810T T=1.40mm 0.239kg/m	
YLJ23896 T=0.80mm 0.142kg/m		YLJ23898 T=1.40mm 0.591kg/m		YLJ23883 T=0.90mm 0.112kg/m	
YLJ23884 T=0.80mm 0.089kg/m 喷涂专用		YLJ23892 T=2.00mm 0.524kg/m		YLJ23807 T=1.50mm 0.364kg/m	
YLJ23813 T=1.30mm 0.207kg/m		YLJ23813A T=1.30mm 0.252kg/m		YLJ23813B T=1.00mm 0.177kg/m	

注：图中所示为标注厚度的理论重量，实际重量以过磅时的重量为准。



型号厚度 米重/kgm	产品图例	型号厚度 米重/kgm	产品图例	型号厚度 米重/kgm	产品图例
YLJ23813C T=1.30mm 0.212kg/m		YLJ23813P T=0.80mm 0.146kg/m		YLJ23813F T=1.00mm 0.163kg/m	
YLJ23813L T=1.10mm 0.182kg/m		YLJ23814 T=1.00mm 0.248kg/m YLJ23814T T=1.40mm 0.314kg/m		YLJ23897 T=1.25mm 0.244kg/m	
YLJ23816 T=0.90mm 0.279kg/m YLJ23816A T=1.20mm 0.325kg/m YLJ23816C T=1.10mm 0.301kg/m YLJ23816P T=0.80mm 0.220kg/m		YLJ23816HT T=1.10mm 0.303kg/m		YLJ23816D T=1.10mm 0.316kg/m	
YLJ23801 T=1.20mm 0.374kg/m YLJ23801P* T=(1.20mm) 0.320kg/m YLJ23801T T=1.40mm 0.405kg/m		YLJ23801A T=1.40mm 0.419kg/m		YLJ23801B T=1.20mm 0.407kg/m	
YLJ23801CT T=1.40mm 0.457kg/m		YLJ23820 T=1.20mm 0.374kg/m YLJ23820A T=1.40mm 0.418kg/m YLJ23820P* T=(1.20mm) 0.365kg/m		YLJ23824 T=1.20mm 0.414kg/m	

38系列平开窗型材图

Aluminium Profiles for Series 38 Casement Window

永利坚铝材 YONGLIJIAN



型号厚度 米重/kgm	产品图例	型号厚度 米重/kgm	产品图例	型号厚度 米重/kgm	产品图例
YLJ23841 T=2.05mm 0.498kg/m		YLJ23802 T=1.20mm 0.553kg/m YLJ23802P* T=(1.20mm) 0.481kg/m YLJ23802T T=1.40mm 0.600kg/m		YLJ23832 T=1.20mm 0.536kg/m	
YLJ23832P* T=(1.20mm) 0.473kg/m		YLJ23832A T=1.80mm 0.692kg/m		YLJ23832B T=1.30mm 0.616kg/m	
YLJ23894 T=1.40mm 0.561kg/m		YLJ23833 T=1.80mm 0.653kg/m		YLJ23803 T=1.30mm 0.673kg/m YLJ23803P* T=(1.20mm) 0.599kg/m	
YLJ23804 T=1.20mm 0.606kg/m YLJ23804P* T=(1.20mm) 0.589kg/m YLJ23804T T=1.4mm 0.673kg/m		YLJ23844 T=2.05mm 0.803kg/m		YLJ23852 T=2.05mm 0.836kg/m	
YLJ23853 T=2.05mm 0.803kg/m		YLJ23818 T=1.30mm 1.061kg/m		YLJ23828 T=1.30mm 0.441kg/m	

注：图中所示为标注厚度的理论重量，实际重量以过磅时的重量为准。



型号厚度 米重/kgm	产品图例	型号厚度 米重/kgm	产品图例	型号厚度 米重/kgm	产品图例
YLJ23826A T=2.00mm 0.573kg/m YLJ23826B T=1.50mm 0.527kg/m		YLJ23860 T=1.50mm 0.233kg/m		YLJ23806 T=4.55mm 1.149kg/m	
YLJ23871A T=6.40mm 0.966kg/m		YLJ23879A T=7.80mm 1.587kg/m		YLJ23808 T=1.20mm 0.383kg/m	
YLJ23873A T=1.30mm 0.417kg/m		YLJ23815A T=1.40mm 0.742kg/m		YLJ23821P* T=(1.20mm) 0.436kg/m	
YLJ23822 T=1.50mm 0.765kg/m YLJ23822P* T=(1.20mm) 0.534kg/m		YLJ23822A T=1.20mm 0.453kg/m		YLJ23822B T=1.40mm 0.604kg/m	
YLJ23822C T=1.40mm 0.549kg/m		YLJ23825 T=1.20mm 0.661kg/m		YLJ23825A T=1.40mm 0.753kg/m	

38系列平开窗型材图

Aluminium Profiles for Series 38 Casement Window

永利坚铝材 YONGLIJIAN



型号厚度 米重/kgm	产品图例	型号厚度 米重/kgm	产品图例	型号厚度 米重/kgm	产品图例
YLJ238856P* T=(1.20mm) 0.482kg/m		YLJ23882P T=1.25mm 0.740kg/m		YLJ23885 T=1.40mm 0.742kg/m	
YLJ23887* T=(1.20mm) 0.538kg/m		YLJ23891 T=1.20mm 0.341kg/m		YLJ19123 T=1.40mm 0.314kg/m	

注：图中所示为标注厚度的理论重量，实际重量以过磅时的重量为准。

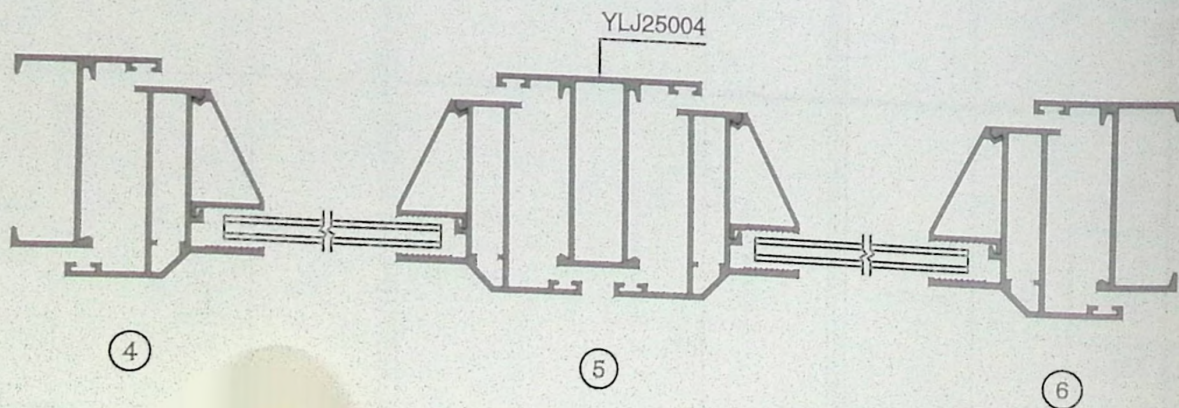
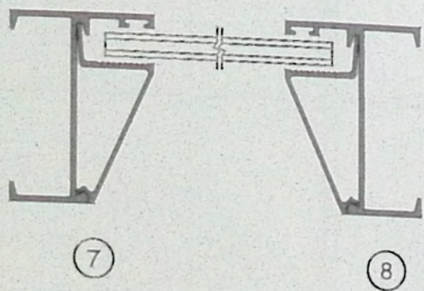
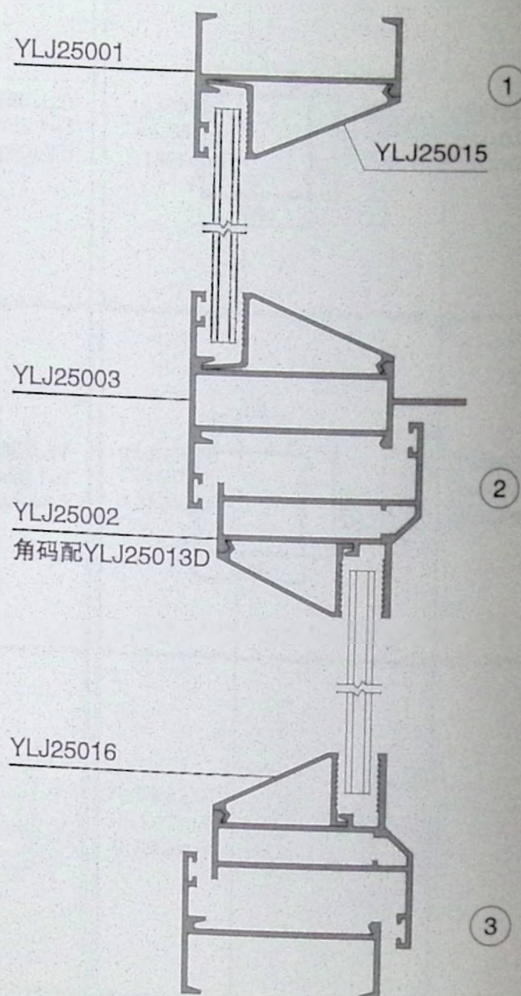
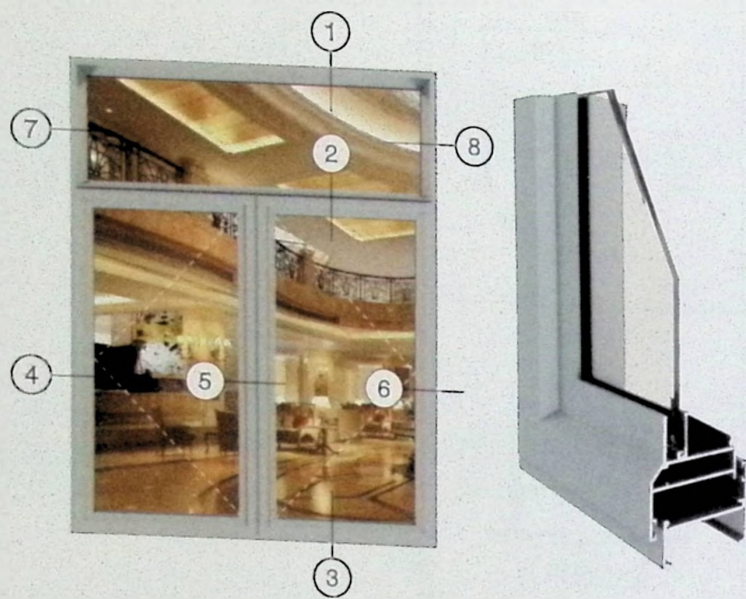

50平开窗(中空)系列结构图
Structure Diagram of Series 50 Casement Window(Hollow)

永利坚铝材 YONGLIJIAN

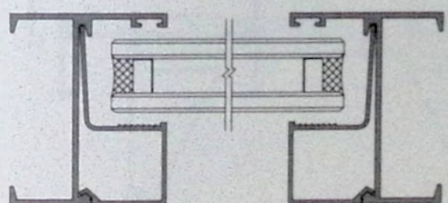
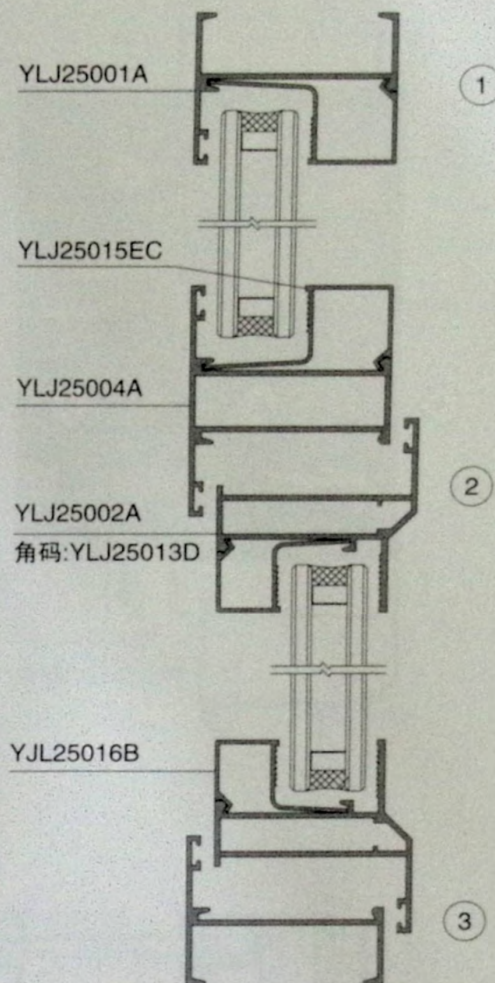
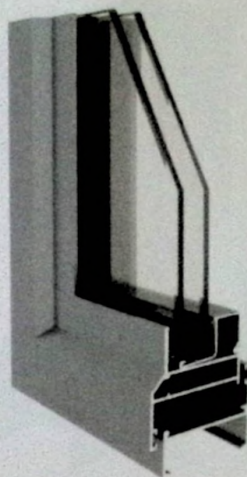
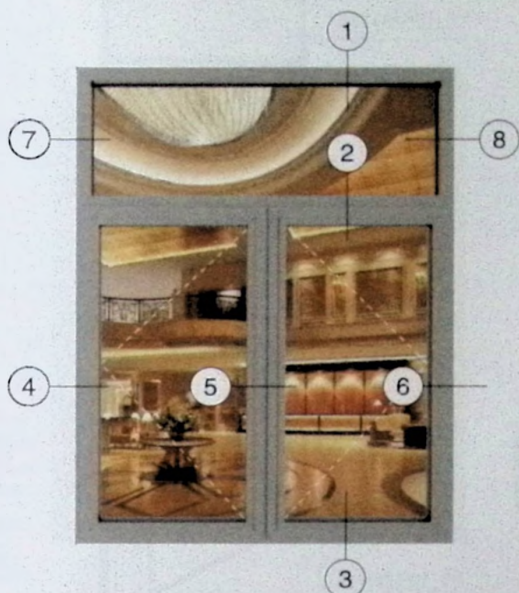

7

8



4

5

6

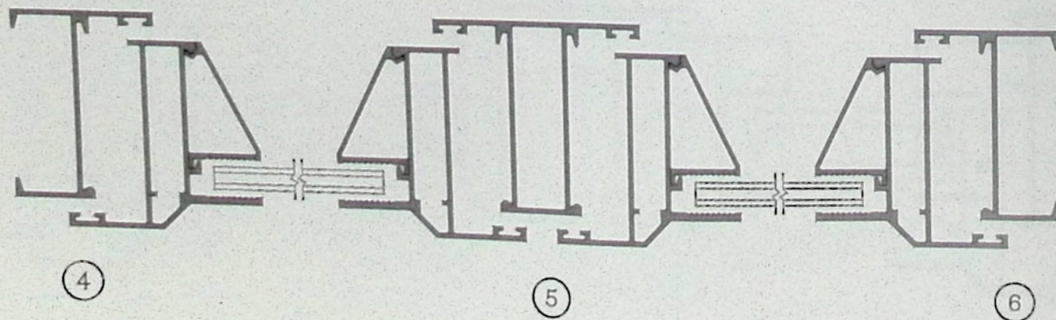
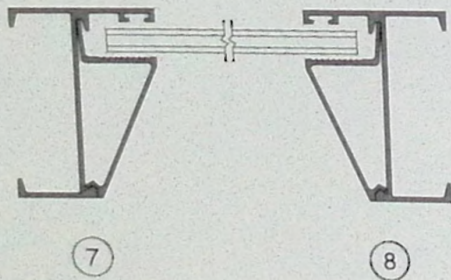
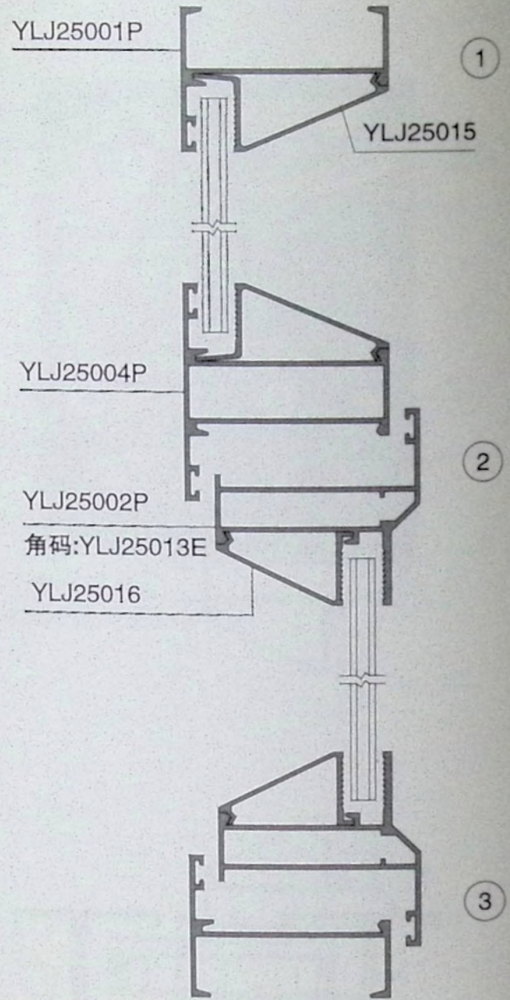
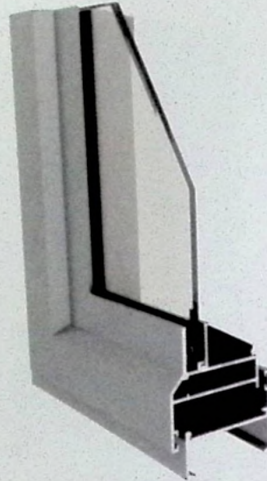
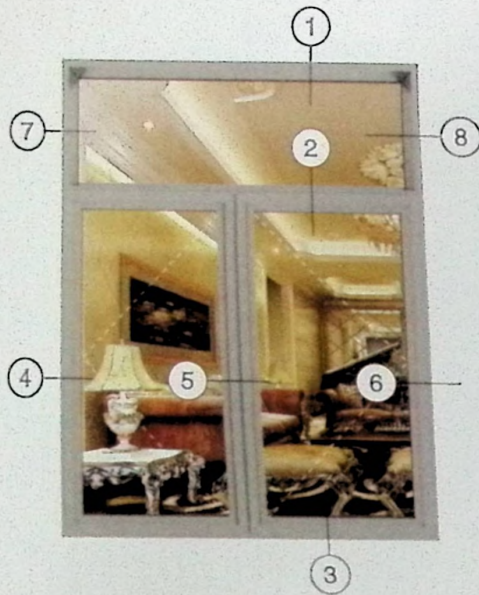

50平开窗系列结构图

Structure Diagram of Series 50 Casement Window

永利坚铝材 YONGLIJIAN

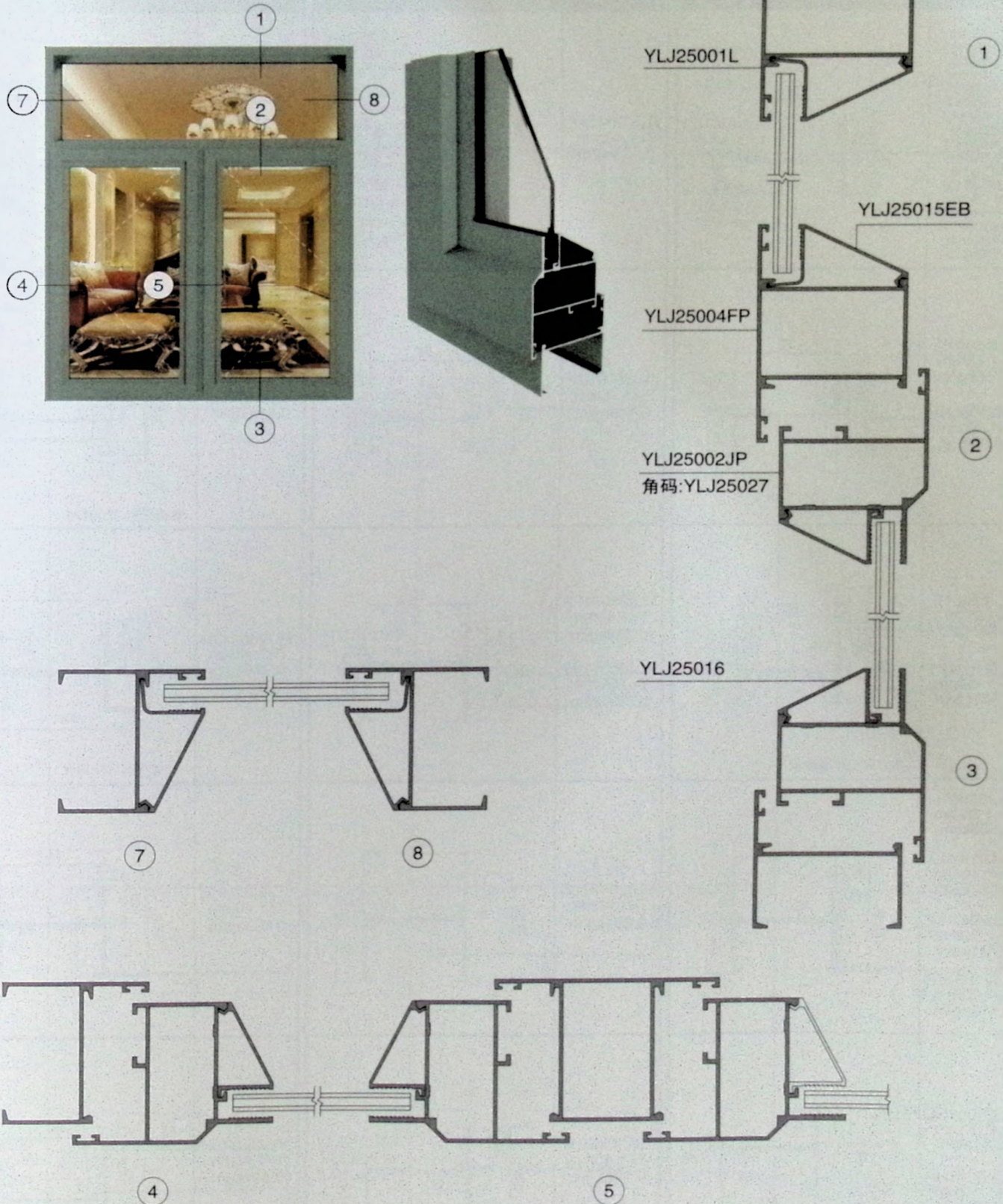



型号厚度 米重/kgm	产品图例	型号厚度 米重/kgm	产品图例	型号厚度 米重/kgm	产品图例
YLJ25001P T=1.20mm 0.435kg/m YLJ25001 T=1.40mm 0.480kg/m YLJ25001T T=1.60mm 0.525kg/m YLJ25001H T=2.00mm 0.611kg/m YLJ25001M T=1.25mm 0.446kg/m YLJ25001TA T=1.35mm 0.469kg/m		YLJ25001AE T=1.40mm 0.533kg/m		YLJ25001A T=1.40mm 0.487kg/m YLJ25001AP T=1.20mm 0.437kg/m YLJ25001AG T=1.40mm 0.487kg/m	
YLJ25001B T=1.40mm 0.510kg/m YLJ25001BP T=1.35mm 0.499kg/m		YLJ25001DP T=(1.15mm) 0.446kg/m		YLJ25001E T=1.40mm 0.668kg/m	
YLJ25001F T=1.20mm 0.493kg/m YLJ25001FT T=1.40mm 0.551kg/m		YLJ25001FA T=1.40mm 0.638kg/m YLJ25001FP T=1.20mm 0.577kg/m		YLJ25001JH T=2.00mm 0.726kg/m	
YLJ25001L T=1.20mm 0.505kg/m YLJ25001LT T=1.40mm 0.562kg/m YLJ25001LA T=2.00mm 0.731kg/m YLJ25001LB T=1.60mm 0.619kg/m		YLJ25001LC T=1.40mm 0.601kg/m		YLJ25001LD T=1.40mm 0.633kg/m	
YLJ25001HQ T=2.00mm 0.731kg/m YLJ25001HR T=1.40mm 0.562kg/m		YLJ25001R T=1.40mm 0.578kg/m		YLJ25001Y T=1.40mm 0.391kg/m	

角码配YLJ25013A

50系列平开窗型材图 (二)

Aluminium Profiles for Series 50 Casement Window

永利坚铝材 YONGLIJIAN



型号厚度 米重/kgm	产品图例	型号厚度 米重/kgm	产品图例	型号厚度 米重/kgm	产品图例
YLJ25005P T=1.20mm 0.408kg/m YLJ25005T T=1.60mm 0.489kg/m		YLJ25006P T=1.20mm 0.466kg/m YLJ25006C T=1.30mm 0.489kg/m YLJ25006 T=1.40mm 0.512kg/m YLJ25006T T=1.60mm 0.562kg/m		YLJ25006A T=1.40mm 0.519kg/m YLJ25006AP T=1.20mm 0.472kg/m YLJ25006AT T=1.60mm 0.565kg/m	
YLJ25007 T=1.35mm 0.501kg/m		YLJ25014 T=1.40mm 0.562kg/m		YLJ25030 T=1.70mm 0.719kg/m	 角码配YL5019TA
YLJ25030A T=1.40mm 0.664kg/m	 角码配YLJ25013A	YLJ25030P T=1.20mm 0.569kg/m		YLJ25030F T=1.40mm 0.913kg/m	 角码配YLJ250J13
YLJ25030M T=1.60mm 1.884kg/m		YLJ25030MA T=2.00mm 2.748kg/m		YLJ25073 T=1.40mm 1.039kg/m	
YLJ25090 T=1.40mm 1.331kg/m		YLJ250107 T=1.40mm 1.033kg/m		YLJ250110 T=2.00mm 0.713kg/m	

注：图中所示为标注厚度的理论重量，实际重量以过磅时的重量为准。



型号厚度 米重/kgm	产品图例	型号厚度 米重/kgm	产品图例	型号厚度 米重/kgm	产品图例
YLJ250116 T=1.40mm 0.847kg/m		YLJ25002 T=1.40mm 0.693kg/m YLJ25002P T=1.20mm 0.634kg/m YLJ25002T T=1.70mm 0.795kg/m	 YLJ25002T配角码YLJ25013A	YLJ25002A T=1.40mm 0.690kg/m YLJ25002H T=2.00mm 0.879kg/m YLJ25002AB T=1.30mm 0.657kg/m YLJ25002AP T=1.20mm 0.625kg/m YLJ25002E T=1.50mm 0.718kg/m	YLJ25002A配角码YLJ25013D YLJ25002H配角码YLJ25013E YLJ25002AB配角码YLJ25013F YLJ25002AP配角码YLJ25013G YLJ25002E配角码YLJ25013H
YLJ25002B T=1.40mm 0.697kg/m	 角码配YLJ25013D	YLJ25002C T=1.40mm 0.870kg/m	 角码配YLJ25027	YLJ25002CA T=1.40mm 0.853kg/m	 角码配YLJ25027
YLJ25002CAA T=1.35mm 0.794kg/m	 角码配YLJ25027	YLJ25002CB T=1.90mm 1.182kg/m	 角码配YLJ45025A	YLJ25002CD T=1.40mm 0.798kg/m	 角码配YLJ25027B
YLJ25002CDA T=1.40mm 0.844kg/m	 角码配YLJ455A25	YLJ25002CDB T=1.40mm 0.840kg/m	 角码配YLJ25027B	YLJ25002CDC T=1.35mm 0.763kg/m	 角码配YLJ460A07A
YLJ25002CDP T=1.35mm 0.780kg/m	 角码配YLJ25027B	YLJ25002CE T=1.90mm 1.004kg/m	 角码配YLJ25027B	YLJ25002CF T=1.90mm 1.019kg/m	 角码配YLJ25027B

50系列平开窗型材图 (四)

Aluminium Profiles for Series 50 Casement Window

永利坚铝材 YONGLIJIAN



型号厚度 米重/kgm	产品图例	型号厚度 米重/kgm	产品图例	型号厚度 米重/kgm	产品图例
YLJ25002CH T=2.00mm 1.099kg/m		YLJ25002CJ T=1.40mm 0.842kg/m		YLJ25002CP T=1.25mm 0.704kg/m	
	角码配YLJ25027		配角码YLJ25027		角码配YLJ25013D
YLJ25002D T=1.35mm 0.748kg/m		YLJ25002DA T=1.20mm 0.706kg/m		YLJ25002DP T=1.20mm 0.608kg/m	
	角码配YLJ25027B		配角码YLJ25027		角码配YLJ25013E
YLJ25002JP T=1.20mm 0.775kg/m		YLJ25002K T=1.35mm 0.648kg/m		YLJ25002W T=1.40mm 0.949kg/m	
	角码配YLJ25027		角码配YLJ25013F	YLJ25002WP T=1.20mm 0.880kg/m	YLJ25002WP配角码YLJ25027
YLJ25002WA T=1.40mm 0.923kg/m		YLJ25002WB T=1.40mm 0.870kg/m		YLJ25032 T=1.35mm 0.637kg/m	
	角码配YLJ25027		配角码YLJ460A07		角码配YLJ25013F
YLJ25034A T=1.40mm 0.774kg/m		YLJ25002L T=1.30mm 0.635kg/m		YLJ25002LA T=2.00mm 0.916kg/m	
	角码配YLJ25026		配YLJ25013L		角码配YLJ25013D

注：图中所示为标注厚度的理论重量，实际重量以过磅时的重量为准。



型号厚度 米重/kgm	产品图例	型号厚度 米重/kgm	产品图例	型号厚度 米重/kgm	产品图例
YLJ25002Q T=1.40mm 0.891kg/m	 角码配LMC60107	YLJ25002QH T=1.35mm 0.758kg/m	 角码配YLJ25013D	YLJ25002R T=2.00mm 1.318kg/m	
YLJ25002BA T=1.40mm 0.849kg/m	 角码配YLJ460A07A	YLJ25002VH T=2.00mm 1.268kg/m	 角码配YLJ455A26	YLJ25002TA T=1.50mm 0.769kg/m	
YLJ250119 T=1.40mm 0.755kg/m	 角码配YLJ25013D	YLJ25054 T=1.40mm 0.775kg/m	 配角码YLJ25013D	YLJ250109 T=1.35mm 0.827kg/m	
YLJ250112 T=2.00mm 0.923kg/m	 角码配YLJ25013D	YLJ25003 T=1.40mm 0.843kg/m YLJ25003P T=1.20mm 0.768kg/m YLJ25003T T=1.60mm 0.917kg/m	 角码配YLJ25013D	YLJ25003A T=1.40mm 0.873kg/m	
YLJ25003AH T=2.00mm 1.209kg/m	 角码配YLJ25013D	YLJ25004 T=1.40mm 0.769kg/m YLJ25004T T=1.60mm 0.849kg/m YLJ25004H T=2.00mm 0.989kg/m YLJ25004P T=1.20mm 0.694kg/m YLJ25004M T=1.25mm 0.713kg/m YLJ25004DP T=1.35mm 0.743kg/m	 角码配YLJ25013D	YLJ25004A T=1.40mm 0.786kg/m YLJ25004AT T=1.60mm 0.861kg/m YLJ25004AP T=1.20mm 0.707kg/m YLJ25004AG T=1.40mm 0.786kg/m	

注: 图中所示为标注厚度的理论重量, 实际重量以过磅时的重量为准。

50系列平开窗型材图 (六)

Aluminium Profiles for Series 50 Casement Window

永利坚铝材 YONGLIJIAN



型号厚度 米重/kgm	产品图例	型号厚度 米重/kgm	产品图例	型号厚度 米重/kgm	产品图例
YLJ25004HR T=1.40mm 0.783kg/m		YLJ25004AB T=2.00mm 1.024kg/m		YLJ25004AE T=1.40mm 0.804kg/m	
YLJ25004AD T=1.40mm 0.854kg/m		YLJ25004B T=1.40mm 0.840kg/m		YLJ25004F T=1.40mm 0.861kg/m	
YLJ25004FP T=1.20mm 0.812kg/m		YLJ25004FT T=1.40mm 0.831kg/m		YLJ25004G T=1.60mm 2.166kg/m	
YLJ25004K T=1.40mm 0.840kg/m		YLJ25004KP T=1.20mm 0.863kg/m		YLJ25004L T=1.35mm 1.027kg/m	
YLJ25004NP T=1.20mm 0.755kg/m		YLJ25004AH T=1.40mm 0.959kg/m		YLJ25004S T=1.30mm 1.093kg/m	
YLJ25004R T=1.40mm 0.914kg/m		YLJ25004RP T=1.35mm 0.892kg/m			

注：图中所示为标注厚度的理论重量，实际重量以过磅时的重量为准。



型号厚度 米重/kgm	产品图例	型号厚度 米重/kgm	产品图例	型号厚度 米重/kgm	产品图例
YLJ25004SA T=1.40mm 1.299kg/m		YLJ25004SB T=1.30mm 1.157kg/m		YLJ25034 T=1.35mm 0.752kg/m	
YLJ250113 T=2.00mm 1.088kg/m		YLJ25023 T=1.70mm 1.502kg/m		YLJ25023A T=1.40mm 1.439kg/m	
YLJ25023AB T=1.40mm 1.515kg/m		YLJ25023AC T=1.75mm 1.619kg/m		YLJ25023B T=1.10mm 0.879kg/m	
YLJ25023BA T=1.40mm 1.037kg/m		YLJ25023D T=2.20mm 2.078kg/m		YLJ25023DA T=1.40mm 1.453kg/m	
YLJ25023E T=1.40mm 1.197kg/m		YLJ25023F T=1.40mm 1.182kg/m		YLJ25023H T=1.50mm 1.286kg/m	

50系列平开窗型材图 (八)

Aluminium Profiles for Series 50 Casement Window

永利坚铝材 YONGLIJIAN



型号厚度 米重/kgm	产品图例	型号厚度 米重/kgm	产品图例	型号厚度 米重/kgm	产品图例
YLJ25023HA T=1.40mm 1.205kg/m		YLJ25023HR T=1.40mm 1.058kg/m		YLJ25023J T=2.20mm 3.140kg/m	
YLJ25023T T=1.40mm 1.060kg/m		YLJ25023TA T=1.40mm 1.128kg/m		YLJ25023X T=1.35mm 1.134kg/m	
YLJ25023K T=1.40mm 1.130kg/m		YLJ25023L T=1.60mm 1.490kg/m		YLJ25023M T=2.00mm 2.460kg/m	
YLJ25023MA T=2.00mm 2.900kg/m		YLJ25023QH T=1.35mm 1.149kg/m		YLJ25023Z T=2.00mm 2.147kg/m	
YLJ25061 T=1.80mm 1.152kg/m		YLJ25085 T=1.40mm 1.083kg/m		YLJ250118 T=1.40mm 0.977kg/m	

注：图中所示为标注厚度的理论重量，实际重量以过磅时的重量为准。



产品图例		产品图例		产品图例	
YLJ250108 T=1.35mm 1.792kg/m		YLJ25020 T=1.20mm 1.157kg/m YLJ25020D T=1.40mm 1.279kg/m		YLJ25020A T=1.40mm 1.272kg/m	
YLJ25020B T=1.60mm 1.488kg/m		YLJ250114 T=2.00mm 1.909kg/m		YLJ25033 T=1.40mm 0.796kg/m	
YLJ25009 T=1.40mm 0.444kg/m		YLJ25009AT T=1.40mm 0.458kg/m YLJ25009AP T=1.20mm 0.415kg/m		YLJ25009B T=1.40mm 0.452kg/m	
YLJ25009C T=1.20mm 0.399kg/m		YLJ25009T T=1.60mm 0.487kg/m		YLJ25009QH T=1.35mm 0.430kg/m	
YLJ25086 T=1.90mm 0.698kg/m	 配:YLJ25020CB	YLJ25022 T=1.60mm 0.450kg/m		YLJ25022P T=1.20mm 0.368kg/m	

图中所示为标注厚度的理论重量, 实际重量以过磅时的重量为准。

50系列平开窗型材图 (十)

Aluminium Profiles for Series 50 Casement Window

永利坚铝材 YONGLIJIAN



型号厚度 米重/kgm	产品图例	型号厚度 米重/kgm	产品图例	型号厚度 米重/kgm	产品图例
YLJ25022B T=1.40mm 0.411kg/m		YLJ25022T T=1.40mm 0.383kg/m		YLJ25051 T=1.40mm 0.922kg/m	
YLJ25053 T=1.20mm 0.739kg/m		YLJ25010 T=1.70mm 0.795kg/m		YLJ25010A T=1.60mm 0.952kg/m	
YLJ25010C T=1.40mm 0.848kg/m		YLJ25010T T=1.40mm 0.677kg/m		YLJ25010AH T=2.00mm 1.136kg/m	
YLJ25019 T=2.00mm 1.683kg/m		YLJ25011 T=1.40mm 0.848kg/m		YLJ25010BH T=1.80mm 0.999kg/m	
YLJ25011A T=1.40mm 0.920kg/m		YLJ25011P T=1.20mm 0.746kg/m		YLJ250111 T=2.00mm 0.979kg/m	
YLJ25011AT T=1.40mm 0.918kg/m			YLJ25011B T=1.70mm 0.906kg/m		YLJ25011A T=1.40mm 0.920kg/m
YLJ25011AT T=1.40mm 0.918kg/m		YLJ25011B T=1.70mm 0.906kg/m	YLJ25011H T=2.00mm 1.258kg/m		YLJ25011H T=2.00mm 1.258kg/m
YLJ25011AT T=1.40mm 0.918kg/m		YLJ25011B T=1.70mm 0.906kg/m		YLJ25011BT T=1.40mm 0.742kg/m	

注：图中所示为标注厚度的理论重量，实际重量以过磅时的重量为准。



	产品图例		产品图例		产品图例
YLJ250108 T=1.35mm 1.792kg/m		YLJ25020 T=1.20mm 1.157kg/m YLJ25020D T=1.40mm 1.279kg/m		YLJ25020A T=1.40mm 1.272kg/m	
YLJ25020B T=1.60mm 1.488kg/m		YLJ250114 T=2.00mm 1.909kg/m		YLJ25033 T=1.40mm 0.796kg/m	
YLJ25009 T=1.40mm 0.444kg/m		YLJ25009AT T=1.40mm 0.458kg/m YLJ25009AP T=1.20mm 0.415kg/m		YLJ25009B T=1.40mm 0.452kg/m	
YLJ25009C T=1.20mm 0.399kg/m		YLJ25009T T=1.60mm 0.487kg/m		YLJ25009QH T=1.35mm 0.430kg/m	
YLJ25086 T=1.90mm 0.698kg/m	 配:YLJ25002CB	YLJ25022 T=1.60mm 0.450kg/m		YLJ25022P T=1.20mm 0.368kg/m	

50系列平开窗型材图 (十)

Aluminium Profiles for Series 50 Casement Window

永利坚铝材 YONGLIJIAN



型号厚度 米重/kgm	产品图例	型号厚度 米重/kgm	产品图例	型号厚度 米重/kgm	产品图例
YLJ25022B T=1.40mm 0.411kg/m		YLJ25022T T=1.40mm 0.383kg/m		YLJ25051 T=1.40mm 0.922kg/m	
YLJ25053 T=1.20mm 0.739kg/m		YLJ25010 T=1.70mm 0.795kg/m		YLJ25010A T=1.60mm 0.952kg/m	
				YLJ25010AH T=2.00mm 1.136kg/m	
YLJ25010C T=1.40mm 0.848kg/m		YLJ25010T T=1.40mm 0.677kg/m		YLJ25010BH T=1.80mm 0.999kg/m	
				YLJ250111 T=2.00mm 0.979kg/m	
YLJ25019 T=2.00mm 1.683kg/m		YLJ25011 T=1.40mm 0.848kg/m		YLJ25011A T=1.40mm 0.920kg/m	
		YLJ25011P T=1.20mm 0.746kg/m		YLJ25011H T=2.00mm 1.258kg/m	
YLJ25011AT T=1.40mm 0.918kg/m		YLJ25011B T=1.70mm 0.906kg/m		YLJ25011BT T=1.40mm 0.742kg/m	

注：图中所示为标注厚度的理论重量，实际重量以过磅时的重量为准。



型号厚度 米重/kgm	产品图例	型号厚度 米重/kgm	产品图例	型号厚度 米重/kgm	产品图例
YLJ25011G T=1.40mm 0.863kg/m YLJ25011CP T=1.20mm 0.772kg/m		YLJ25011D T=2.00mm 1.154kg/m		YLJ25011F T=1.20mm 0.694kg/m YLJ25011FT T=1.40mm 0.795kg/m	
YLJ25011G T=1.40mm 0.957kg/m		YLJ25011GA T=1.40mm 0.956kg/m		YLJ25011L T=1.40mm 0.662kg/m	
YLJ25011M T=1.35mm 0.923kg/m		YLJ25011N T=1.35mm 0.930kg/m		YLJ25011S T=1.30mm 1.292kg/m	
YLJ25012 T=1.40mm 0.772kg/m		YLJ25012AT T=1.40mm 0.754kg/m		YLJ25012B T=1.40mm 0.786kg/m YLJ25012BP T=1.20mm 0.708kg/m	
YLJ25012CH T=2.00mm 1.176kg/m		YLJ25012EP T=1.20mm 0.818kg/m		YLJ25012F T=1.40mm 1.135kg/m YLJ25012FP T=1.20mm 1.008kg/m	

50系列平开窗型材图 (十二)

Aluminium Profiles for Series 50 Casement Window

永利坚铝材 YONGLIJIAN



型号厚度 米重/kgm	产品图例	型号厚度 米重/kgm	产品图例	型号厚度 米重/kgm	产品图例
YLJ25012FT T=1.40mm 1.022kg/m		YLJ25012L T=1.35mm 1.027kg/m		YLJ25024 T=2.00mm 1.340kg/m YLJ25024A T=1.20mm 0.906kg/m YLJ25024P T=1.50mm 1.088kg/m	
YLJ25024B T=1.20mm 0.906kg/m YLJ25024PA T=1.35mm 0.998kg/m		YLJ25024D T=1.35mm 0.865kg/m		YLJ25024G T=1.40mm 0.965kg/m	
YLJ25024E T=1.40mm 1.040kg/m		YLJ25024F T=1.20mm 1.266kg/m		YLJ25056 T=1.40mm 1.045kg/m	
YLJ25056P T=1.20mm 0.930kg/m		YLJ25057 T=1.40mm 1.045kg/m		YLJ25057P T=1.20mm 0.930kg/m	
YLJ25058T T=1.40mm 1.052kg/m		YLJ25059T T=1.40mm 1.442kg/m		YLJ25060T T=1.40mm 1.243kg/m	

注：图中所示为标注厚度的理论重量，实际重量以过磅时的重量为准。



型号 厚度 米重/kgm	产品图例	型号 厚度 米重/kgm	产品图例	型号 厚度 米重/kgm	产品图例
YLJ25018A T=1.70mm 0.895kg/m		YLJ25018T T=1.40mm 0.841kg/m YLJ25018H T=2.00mm 1.152kg/m		YLJ25055 T=1.40mm 0.827kg/m	
YLJ25055W T=1.40mm 1.224kg/m		YLJ25089 T=1.20mm 0.524kg/m		YLJ25098 T=1.35mm 0.919kg/m	
YLJ25013 T=7.40mm 1.307kg/m		YLJ25013A T=7.90mm 1.367kg/m		YLJ25013B T=8.10mm 1.400kg/m	
YLJ25013C T=8.00mm 1.202kg/m		YLJ25013D T=7.40mm 1.322kg/m		YLJ25013E T=8.90mm 1.405kg/m	
YLJ25013F T=6.70mm 1.024kg/m		YLJ25013G T=5.00mm 1.176kg/m		YLJ25013H T=4.00mm 1.023kg/m	

50系列平开窗型材图 (十四)

Aluminium Profiles for Series 50 Casement Window

永利坚铝材 YONGLIJIAN



型号厚度 米重/kgm	产品图例	型号厚度 米重/kgm	产品图例	型号厚度 米重/kgm	产品图例
YLJ25013L T=4.40mm 1.107kg/m		YLJ25026 T=8.70mm 3.293kg/m		YLJ25027 T=3.00mm 2.188kg/m	
YLJ25027A T=3.00mm 2.223kg/m		YLJ25027B T=3.00mm 2.339kg/m		YLJ25015 T=1.00mm 0.221kg/m	
YLJ25015A T=1.00mm 0.245kg/m		YLJ25015B T=1.00mm 0.244kg/m		YLJ25015C T=1.00mm 0.220kg/m	
YLJ25015D T=1.00mm 0.217kg/m		YLJ25015DA T=0.80mm 0.179kg/m		YLJ25015F T=1.00mm 0.220kg/m	
YLJ25015G T=1.00mm 0.192kg/m		YLJ25015H T=1.00mm 0.254kg/m		YLJ25015J T=1.00mm 0.243kg/m	

注：图中所示为标注厚度的理论重量，实际重量以过磅时的重量为准。



型号厚度 米重/kgm	产品图例	型号厚度 米重/kgm	产品图例	型号厚度 米重/kgm	产品图例
YLJ25015K T=1.00mm 0.257kg/m		YLJ25015M T=1.00mm 0.243kg/m		YLJ25015N T=1.00mm 0.219kg/m	
YLJ25015P T=0.80mm 0.183kg/m		YLJ25015PA T=0.80mm 0.182kg/m		YLJ25015Q T=1.00mm 0.217kg/m	
YLJ25015R T=1.00mm 0.245kg/m		YLJ25015S T=1.00mm 0.252kg/m		YLJ25015T T=1.10mm 0.260kg/m	
YLJ25015TA T=1.00mm 0.238kg/m		YLJ25015W T=1.00mm 0.216kg/m		YLJ25015Y T=1.00mm 0.237kg/m	
YLJ25015E T=1.00mm 0.226kg/m		YLJ25015EA T=1.00mm 0.221kg/m		YLJ25015EB T=1.00mm 0.215kg/m	

50系列平开窗型材图 (十六)

Aluminium Profiles for Series 50 Casement Window

永利坚铝材 YONGLIJIAN



型号厚度 米重/kgm	产品图例	型号厚度 米重/kgm	产品图例	型号厚度 米重/kgm	产品图例
YLJ25015EC T=1.00mm 0.254kg/m		YLJ25015EF T=1.00mm 0.248kg/m		YLJ25015HA T=0.90mm 0.235kg/m	
YLJ25015X T=0.90mm 0.195kg/m		YLJ25015XA T=1.10mm 0.261kg/m		YLJ25015NA T=1.00mm 0.229kg/m	
YLJ25015WA T=1.00mm 0.235kg/m		YLJ25015WB T=0.90mm 0.235kg/m		YLJ25015WC T=0.90mm 0.234kg/m	
YLJ250102 T=1.00mm 0.256kg/m		YLJ25016 T=1.00mm 0.185kg/m		YLJ25016A T=1.00mm 0.204kg/m	
YLJ25016B T=1.00mm 0.204kg/m		YLJ25016C T=1.00mm 0.187kg/m		YLJ25016D T=1.00mm 0.224kg/m	

注：图中所示为标注厚度的理论重量，实际重量以过磅时的重量为准。



型号厚度 米重/kgm	产品图例	型号厚度 米重/kgm	产品图例	型号厚度 米重/kgm	产品图例
YLJ25016E T=1.00mm 0.191kg/m		YLJ25016F T=1.00mm 0.186kg/m		YLJ25016G T=1.00mm 0.203kg/m	
YLJ25016J T=1.00mm 0.225kg/m		YLJ25016JA T=1.00mm 0.232kg/m 喷涂专用		YLJ25016K T=1.00mm 0.180kg/m	
YLJ25016M T=1.00mm 0.211kg/m		YLJ25016N T=1.00mm 0.195kg/m		YLJ25016P T=0.80mm 0.158kg/m	
YLJ25016R T=1.00mm 0.187kg/m		YLJ25016S T=1.00mm 0.207kg/m		YLJ25016U T=1.00mm 0.203kg/m	
YLJ25016UB T=0.90mm 0.185kg/m		YLJ25016UC T=0.90mm 0.187kg/m		YLJ25016V T=1.00mm 0.185kg/m	

50系列平开窗型材图 (十八)

Aluminium Profiles for Series 50 Casement Window

永利坚铝材 YONGLIJIAN



型号厚度 米重/kgm	产品图例	型号厚度 米重/kgm	产品图例	型号厚度 米重/kgm	产品图例
YLJ25016W T=1.00mm 0.179kg/m		YLJ25016WA T=1.00mm 0.183kg/m		YLJ25016X T=0.90mm 0.158kg/m	
YLJ25016Y T=1.00mm 0.194kg/m		YLJ25016JC T=0.90mm 0.198kg/m		YLJ25016T T=0.90mm 0.178kg/m	
YLJ25016Q T=1.10mm 0.219kg/m		YLJ25016MA T=1.00mm 0.231kg/m		YLJ25016MC T=1.00mm 0.235kg/m	
YLJ25050 T=3.00mm 0.318kg/m		YLJ25050A T=2.00mm 0.401kg/m			

注：图中所示为标注厚度的理论重量，实际重量以过磅时的重量为准。

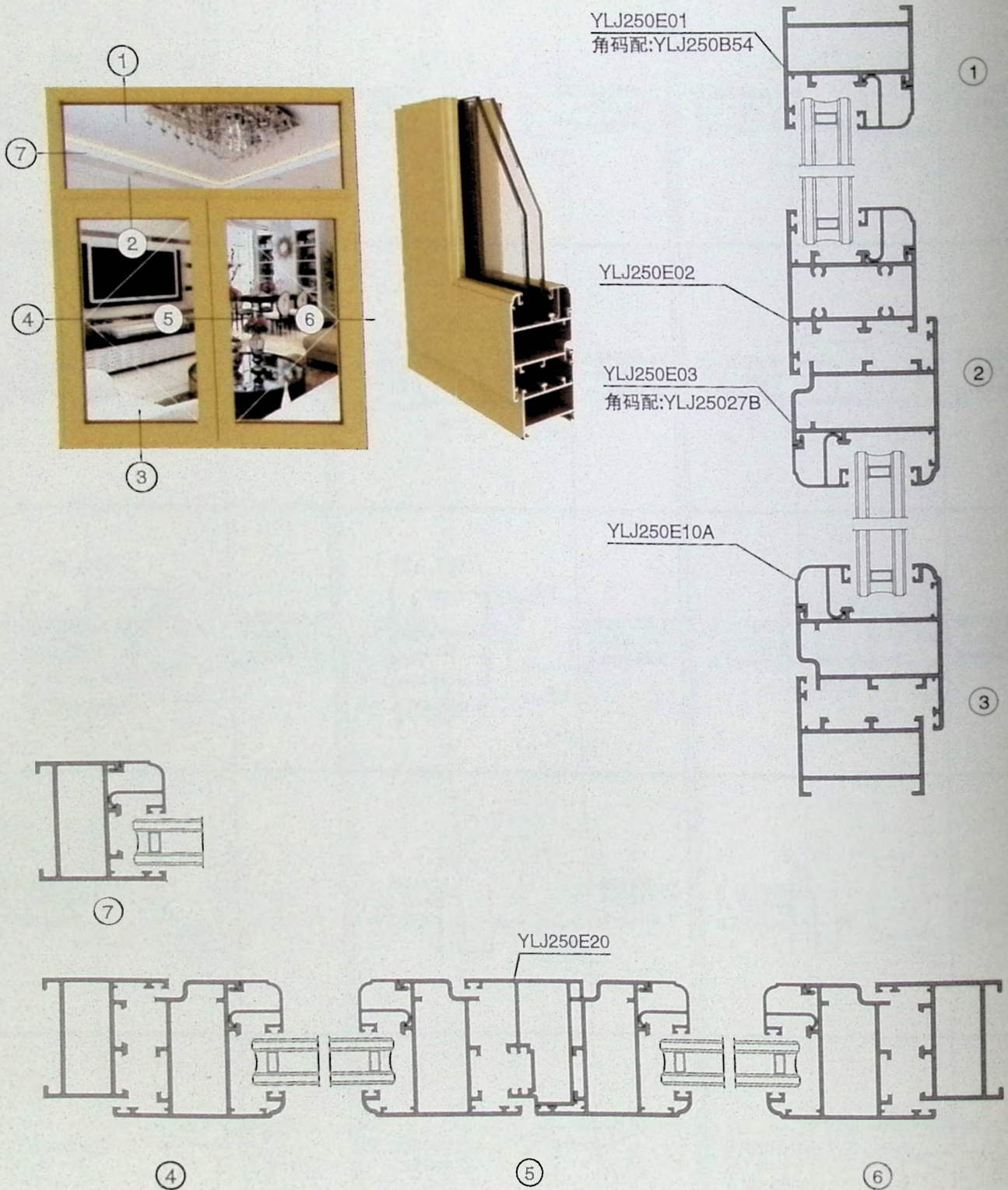

50E系列平开窗结构图
Structure Diagram of Series 50E Casement Window

永利坚铝材 YONGLIJIAN

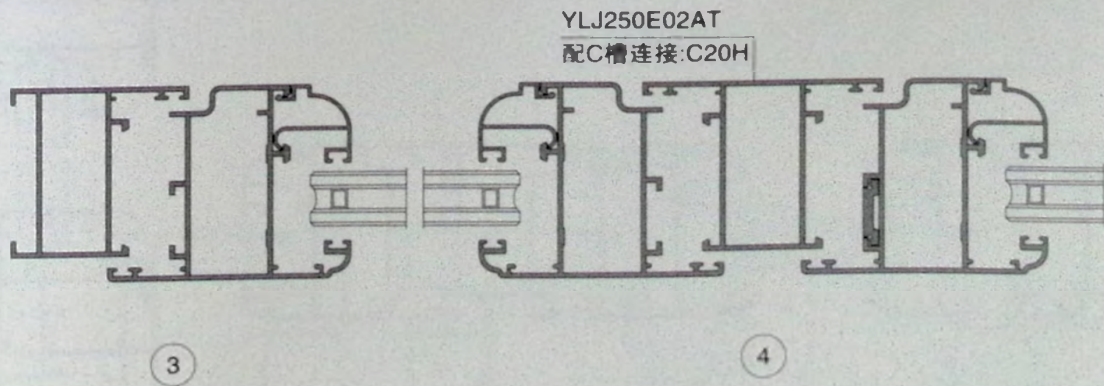
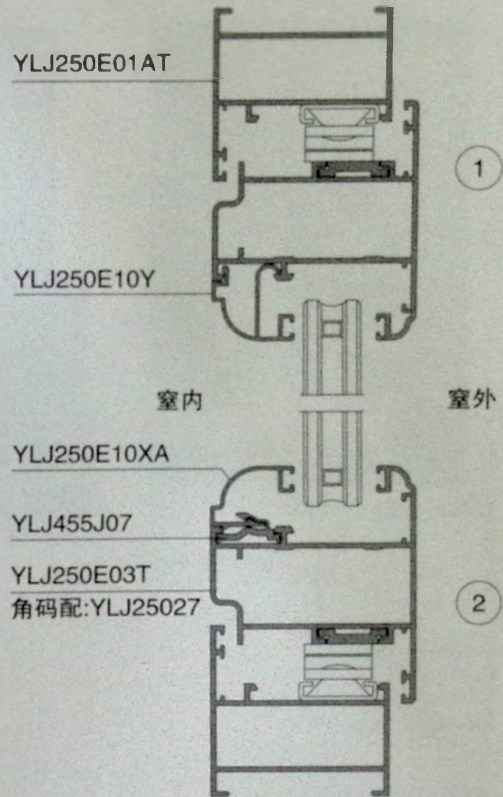
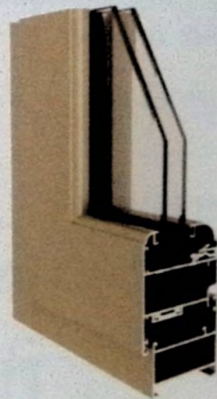
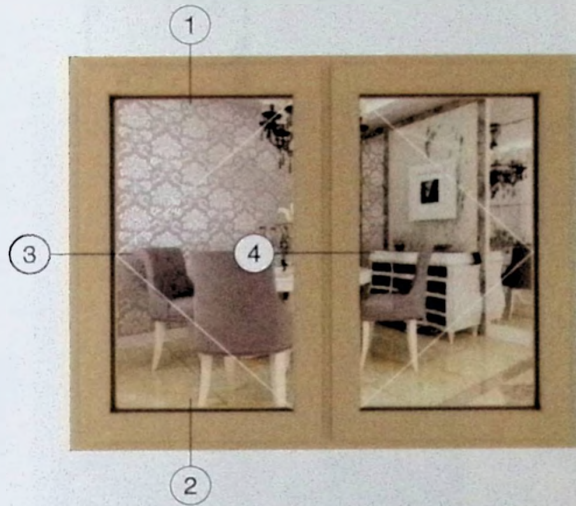

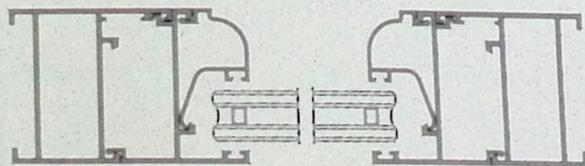
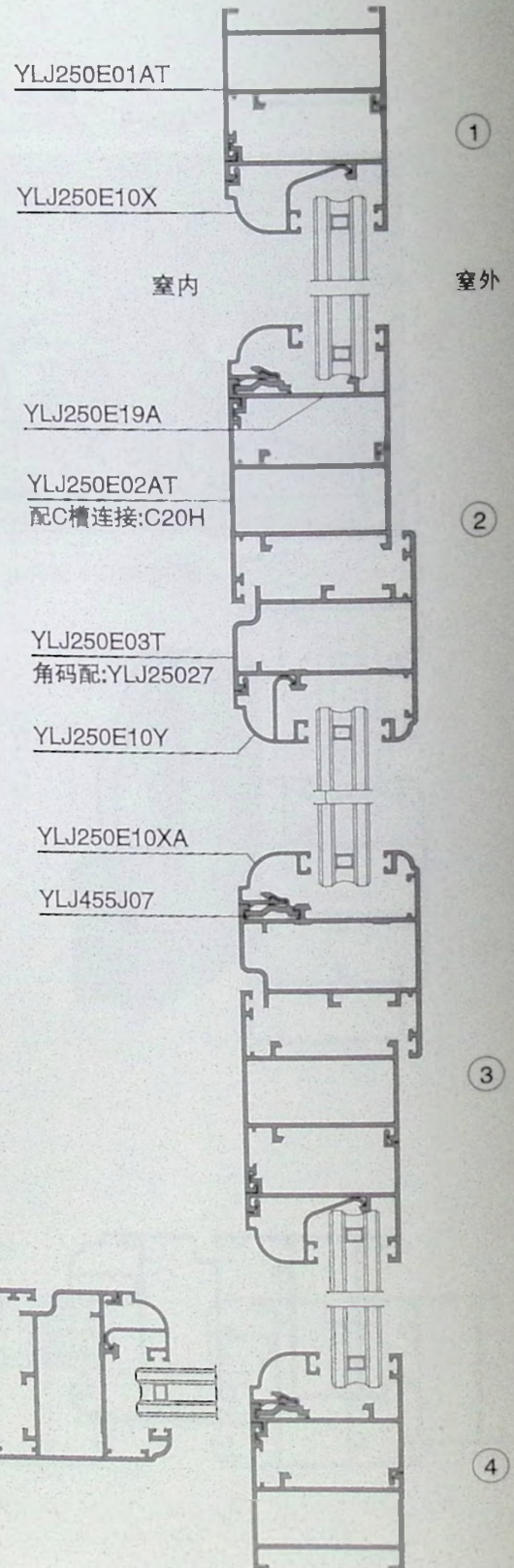
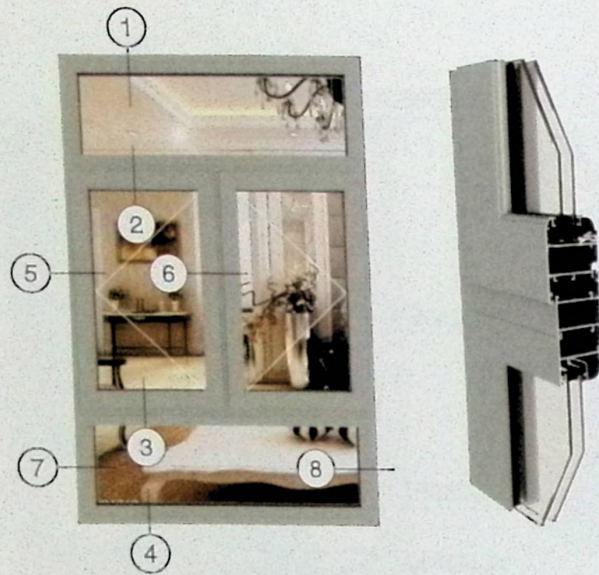

7

8

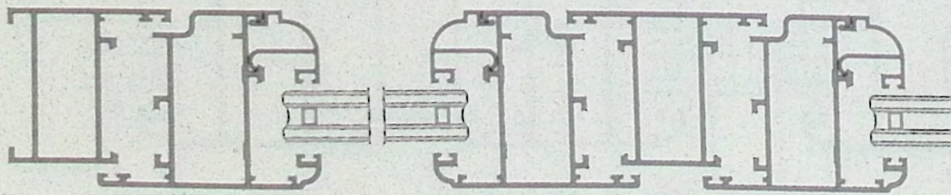

5

6

50E系列平开纱窗结构图
Structure Diagram of Series 50E Casement Window

永利坚铝材 YONGLIJIAN

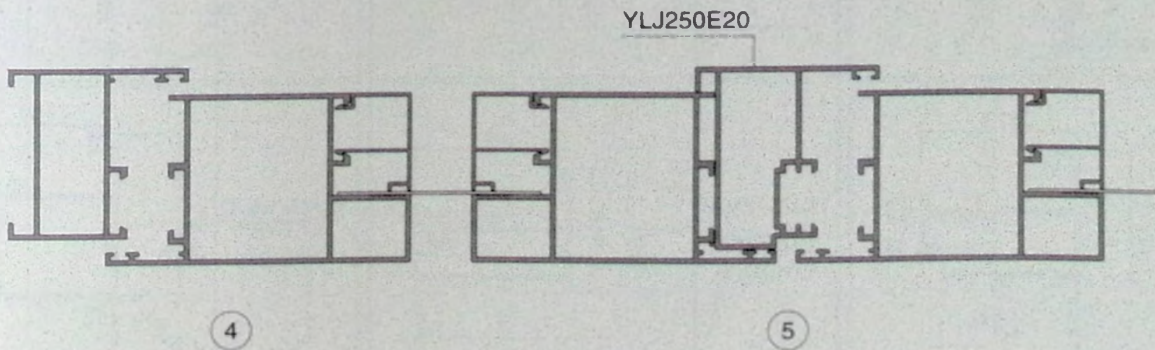
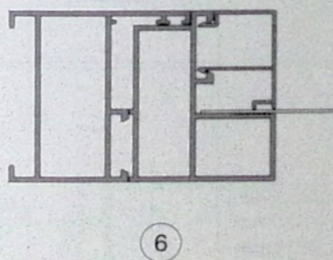
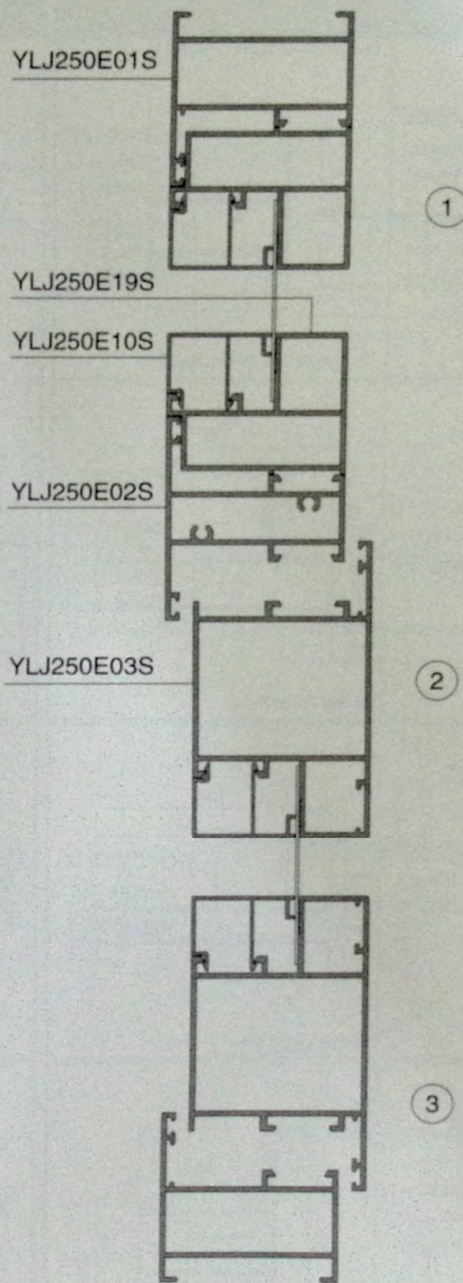



型号厚度 米重/kgm	产品图例	型号厚度 米重/kgm	产品图例	型号厚度 米重/kgm	产品图例
YLJ250E01 T=1.60mm 0.912kg/m YLJ250E01T T=1.40mm 0.812kg/m	YLJ250E01配角码YLJ250B54 	YLJ250E01AT+ T=1.40mm 0.775kg/m		YLJ250E01B T=1.50mm 0.970kg/m	
	YLJ250E017配角码YLJ250B54		角码配YLJ250B54		角码配YLJ455A10
YLJ250E01D T=1.60mm 1.274kg/m		YLJ250E01E T=1.60mm 1.220kg/m		YLJ250E01F T=1.60mm 1.656kg/m	
	角码配YLJ250B54		角码配YLJ250B54		角码配YLJ250B54
YLJ250E01FA T=1.60mm 1.852kg/m		YLJ250E01S T=1.40mm 0.775kg/m		YLJ250E02 T=1.60mm 1.195kg/m	
	角码配YLJ250B54		角码配YLJ250B54		
YLJ250E02AT+ T=1.40mm 0.898kg/m		YLJ250E02S T=1.40mm 0.887kg/m		YLJ250E02T T=1.40mm 1.081kg/m	
YLJ250E03 T=1.60mm 1.149kg/m		YLJ250E03B T=1.50mm 1.012kg/m		YLJ250E03D T=1.60mm 1.280kg/m	
	角码配YLJ25027		角码配YLJ455A10		角码配YLJ34511

50E系列平开窗型材图

Aluminium Profiles for Series 50E Casement Window

永利坚铝材 YONGLIJIAN



型号厚度 米重/kgm	产品图例	型号厚度 米重/kgm	产品图例	型号厚度 米重/kgm	产品图例
YLJ250E03S T=1.40mm 1.198kg/m	 角码配YLJ455A26	YLJ250E03T T=1.40mm 1.060kg/m	 角码配YLJ25027	YLJ250E04 T=1.60mm 1.248kg/m YLJ250E04T T=1.40mm 1.122kg/m	
YLJ250E05 T=1.60mm 1.422kg/m		YLJ250E05A T=1.40mm 1.693kg/m		YLJ250E06 T=1.60mm 1.424kg/m YLJ250E06T T=1.40mm 1.309kg/m	
YLJ250E06TA T=1.40mm 0.877kg/m		YLJ250E07 T=1.60mm 1.594kg/m		YLJ250E08 T=1.60mm 1.808kg/m	
YLJ250E08A T=1.60mm 1.607kg/m		YLJ250E08B T=1.40mm 1.192kg/m		YLJ250E08L T=3.00mm 3.534kg/m	
YLJ250E09 T=1.60mm 1.492kg/m		YLJ250E10 T=1.00mm 0.260kg/m		YLJ250E10A T=1.00mm 0.226kg/m	

注：图中所示为标注厚度的理论重量，实际重量以过磅时的重量为准。



型号厚度 米重/kgm	产品图例	型号厚度 米重/kgm	产品图例	型号厚度 米重/kgm	产品图例
YLJ250E10C T=1.00mm 0.179kg/m		YLJ250E10D T=1.00mm 0.339kg/m		YLJ250E10E T=1.00mm 0.241kg/m	
YLJ250E10F T=1.10mm 0.316kg/m		YLJ250E10G T=1.00mm 0.272kg/m		YLJ250E10L T=1.00mm 0.242kg/m	
YLJ250E10R T=1.10mm 0.267kg/m		YLJ250E10S T=1.00mm 0.217kg/m		YLJ250E10X T=1.00mm 0.234kg/m	
YLJ250E10XA T=1.00mm 0.182kg/m		YLJ250E10Q T=1.00mm 0.235kg/m		YLJ250E10N T=1.00mm 0.233kg/m	
YLJ250E10Y T=1.00mm 0.228kg/m		YLJ250E11 T=1.60mm 0.848kg/m		YLJ250E13 T=1.40mm 0.927kg/m	

角码见YLJ25027

50E系列平开窗型材图

Aluminium Profiles for Series 50E Casement Window

永利坚铝材 YONGLIJIAN



型号厚度 米重/kgm	产品图例	型号厚度 米重/kgm	产品图例	型号厚度 米重/kgm	产品图例
YLJ250E13B T=2.00mm 1.816kg/m		YLJ250E13BA T=2.00mm 2.028kg/m		YLJ250E14 T=1.40mm 1.325kg/m	
YLJ250E15 T=1.10mm 0.226kg/m		YLJ250E19 T=1.40mm 0.494kg/m		YLJ250E19A+ T=1.40mm 0.484kg/m	
YLJ250E19S T=1.40mm 0.786kg/m		YLJ250E20 T=1.40mm 0.826kg/m		YLJ250E21 T=1.40mm 0.273kg/m	
YLJ250E02B T=1.40mm 0.941kg/m		YLJ250E02G T=2.50mm 1.504kg/m		YLJ250E03G T=2.50mm 1.642kg/m	
YLJ250E03L T=1.40mm 1.061kg/m		YLJ250E03TA T=1.40mm 1.031kg/m		YLJ250E04G T=2.50mm 1.747kg/m	

注：图中所示为标注厚度的理论重量，实际重量以过磅时的重量为准。



型号厚度 米重/kgm	产品图例	型号厚度 米重/kgm	产品图例	型号厚度 米重/kgm	产品图例
YLJ250E10V T=1.00mm 0.170kg/m		YLJ250E10XL T=1.00mm 0.298kg/m		YLJ250E22S T=1.40mm 1.350kg/m	
YLJ250E23 T=2.00mm 2.198kg/m		YLJ250E24 T=1.60mm 1.327kg/m		YLJ250E25 T=1.60mm 1.327kg/m	
YLJ250E28 T=1.20mm 0.269kg/m		YLJ250E29 T=3.00mm 0.932kg/m			

50G平开窗结构图

Structure Diagram of Series 50G Casement Window

永利坚铝材 YONGLIJIAN

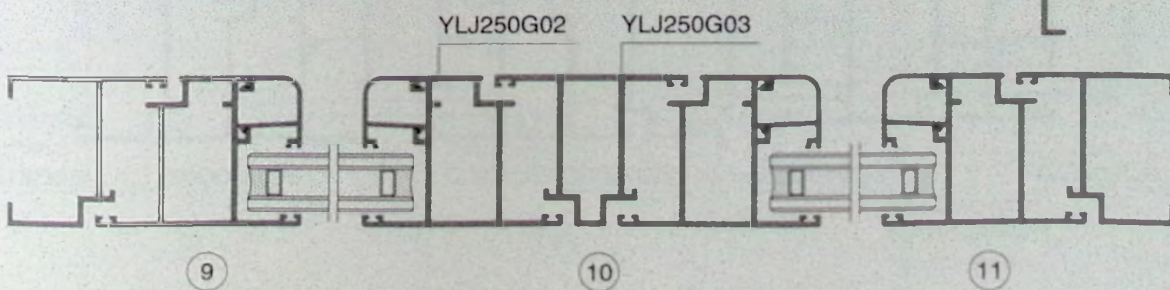
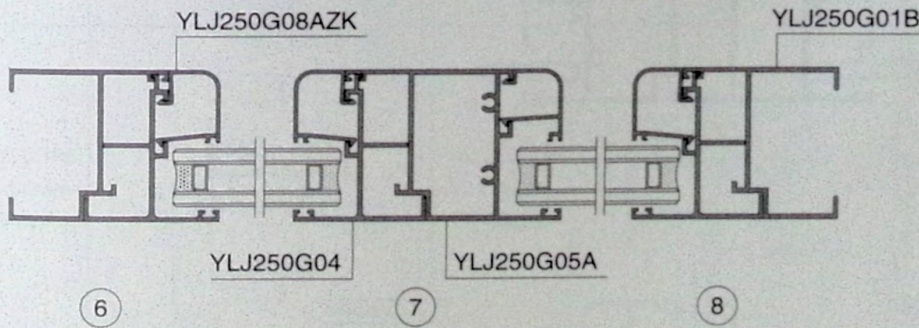
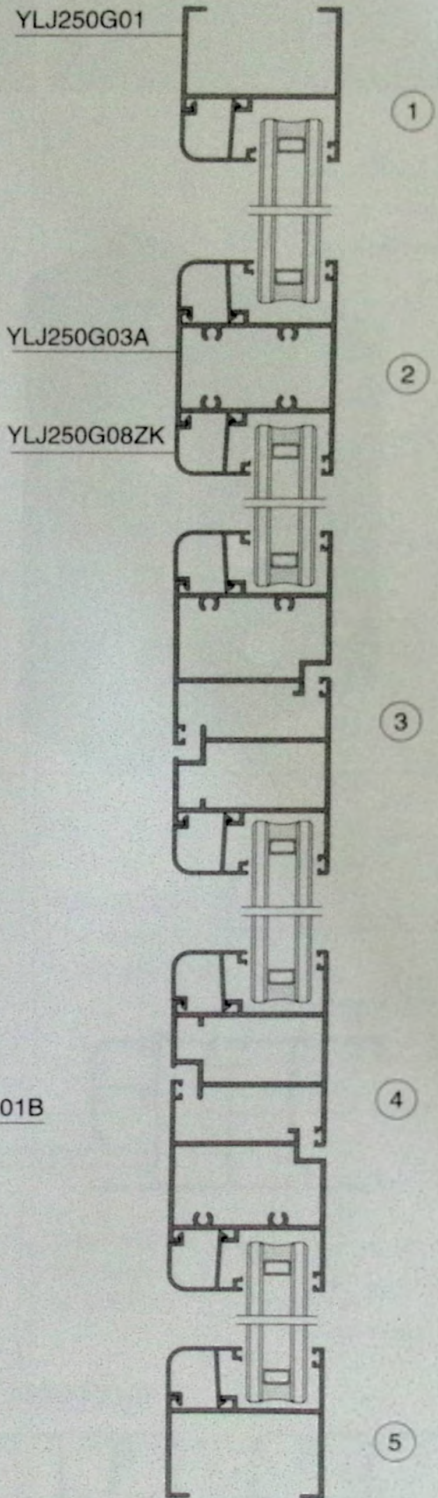
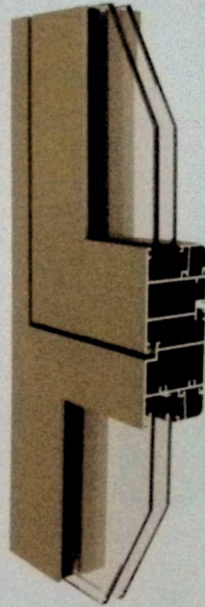
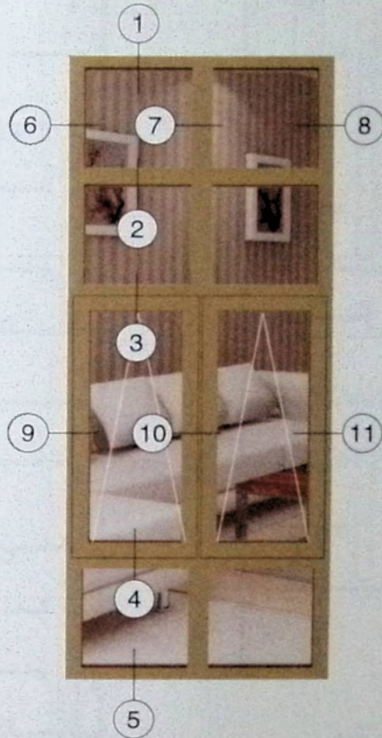

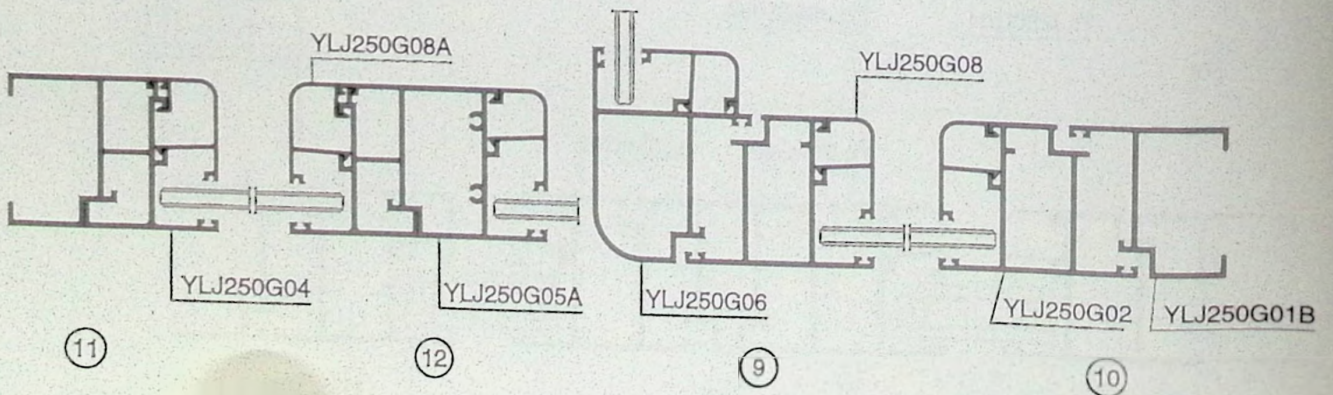
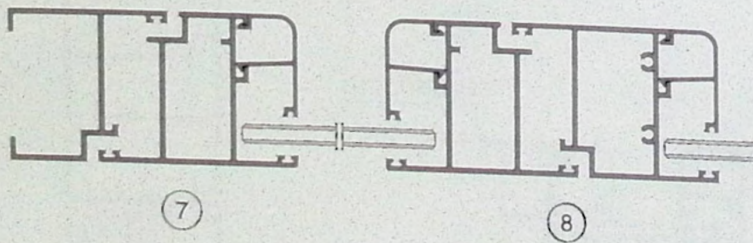
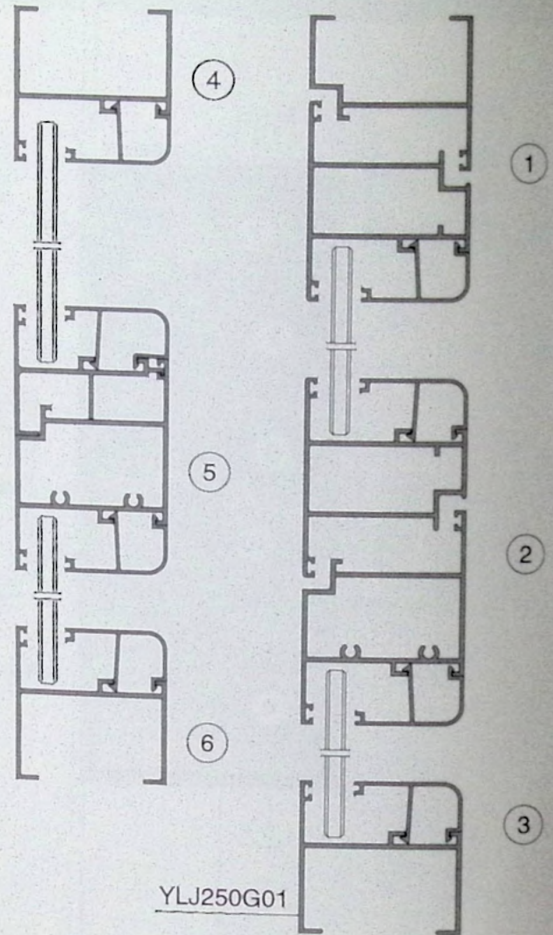
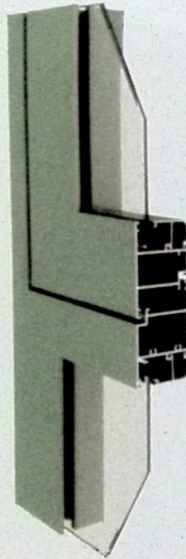

50G平开窗型材图

Aluminium Profiles for Series 50G Casement Window

永利坚铝材 YONGLIJIAN



型号厚度 米重/kgm	产品图例	型号厚度 米重/kgm	产品图例	型号厚度 米重/kgm	产品图例
YLJ250G01 T=1.50mm 0.615kg/m		YLJ250G01B T=1.60mm 0.633kg/m		YLJ250G02 T=1.50mm 0.858kg/m	 角码配YLJ250B54
YLJ250G03 T=1.40mm 0.755kg/m		YLJ250G03A T=1.40mm 0.885kg/m		YLJ250G04 T=1.50mm 0.499kg/m	
YLJ250G05 T=1.50mm 0.899kg/m		YLJ250G05A T=1.50mm 0.947kg/m		YLJ250G05B T=1.40mm 1.261kg/m	
YLJ250G06 T=1.50mm 0.894kg/m		YLJ250G08 T=1.00mm 0.217kg/m		YLJ250G08ZK T=1.00mm 0.191kg/m	
YLJ250G08BZK T=1.00mm 0.167kg/m		YLJ250G08A T=1.00mm 0.235kg/m		YLJ250G08AZK T=1.00mm 0.200kg/m	
				YLJ250G08CZK T=1.00mm 0.192kg/m	

注：图中所示为标注厚度的理论重量，实际重量以过磅时的重量为准。

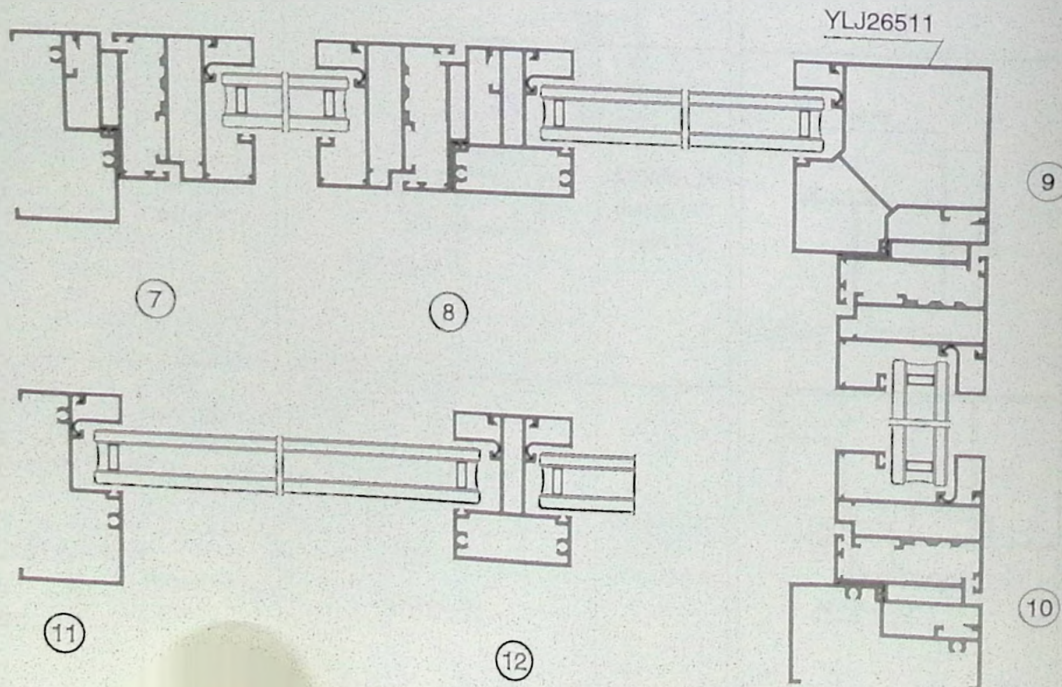
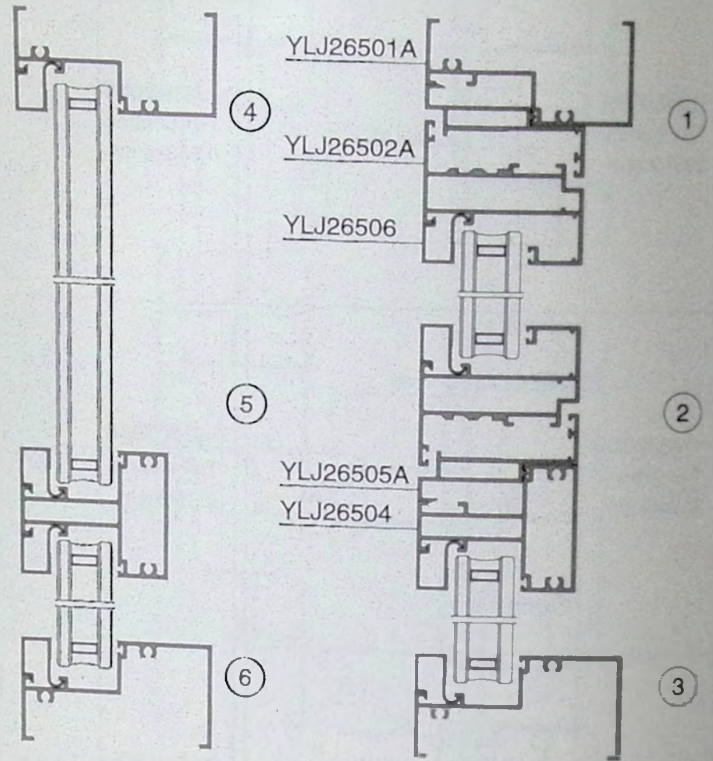
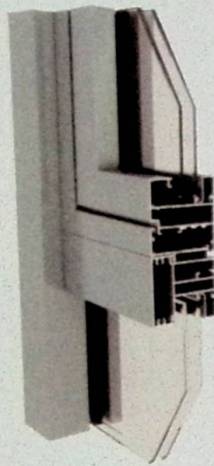
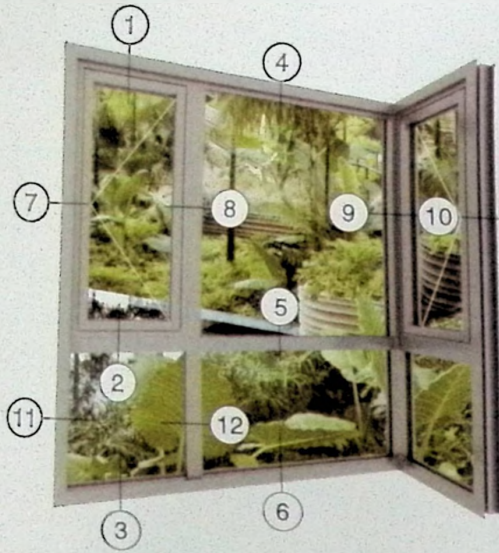

65系列平开窗结构图

Structure Diagram of Series 65 Casement Window

永利坚铝材 YONGLIJIAN

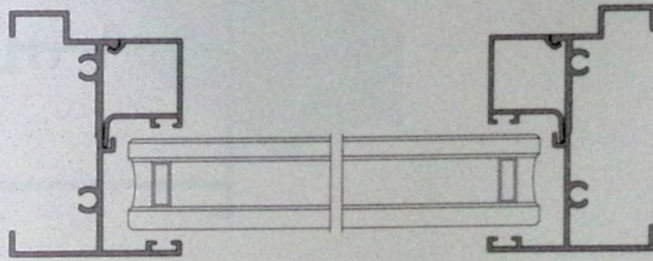
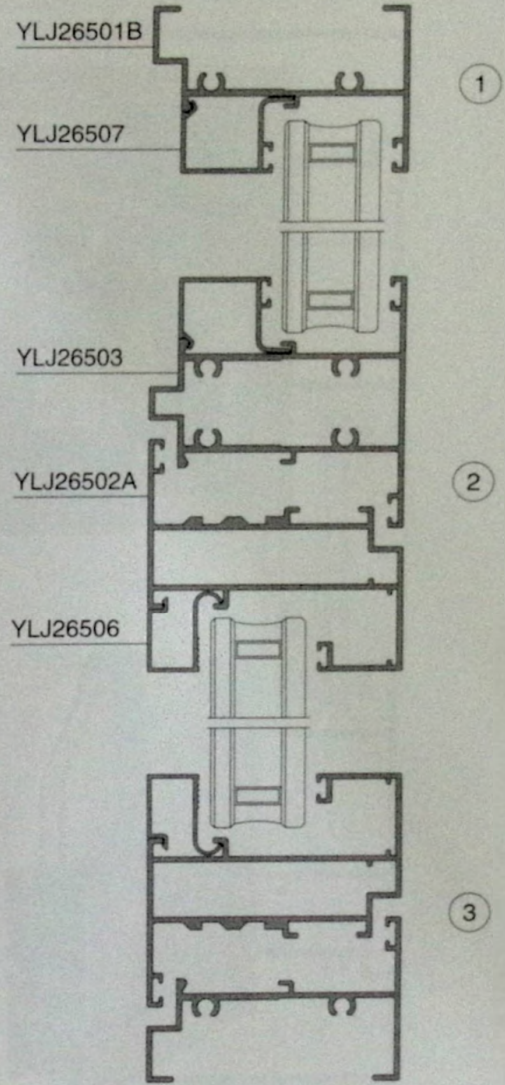
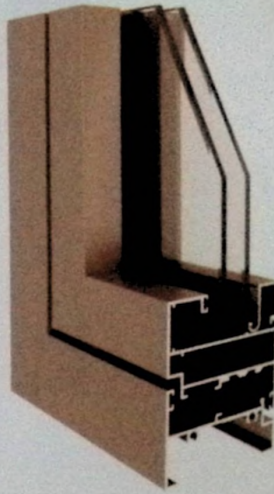
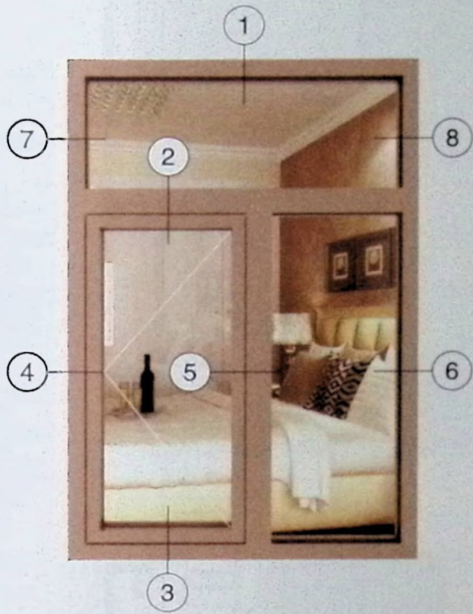

7

8

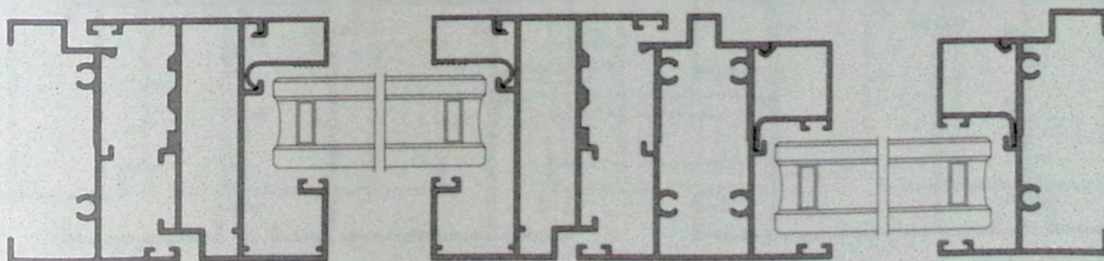

4

5

6

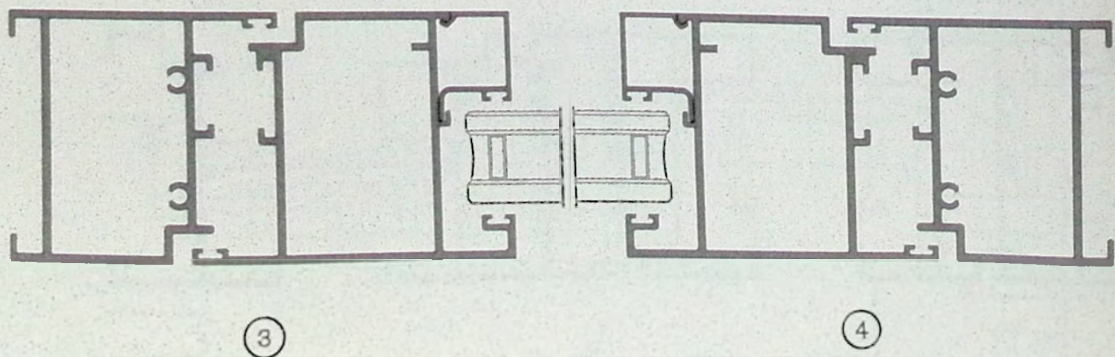
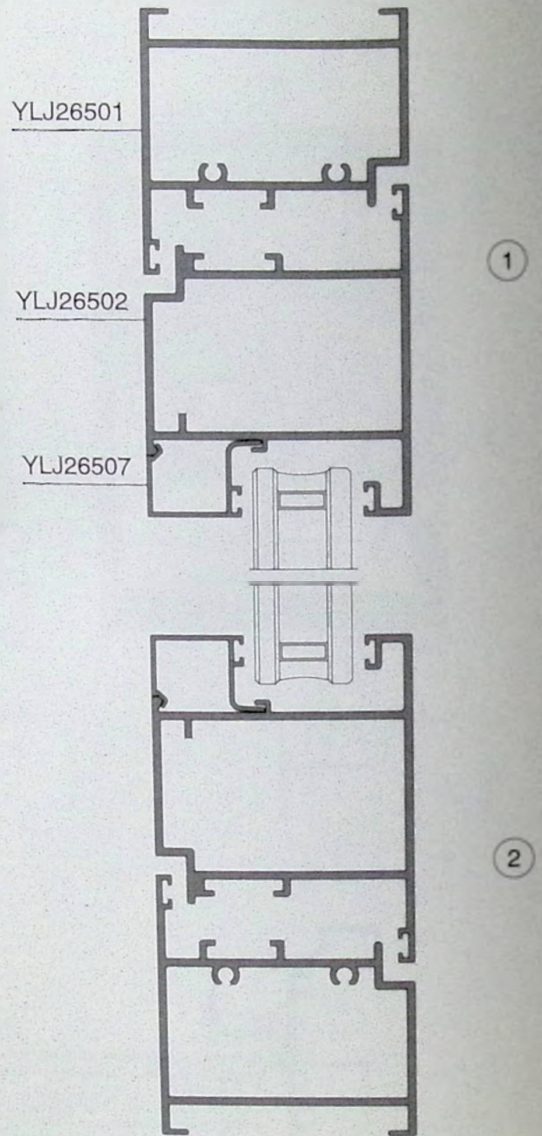
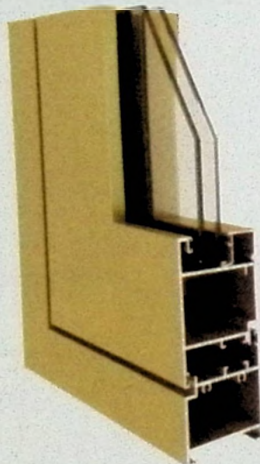
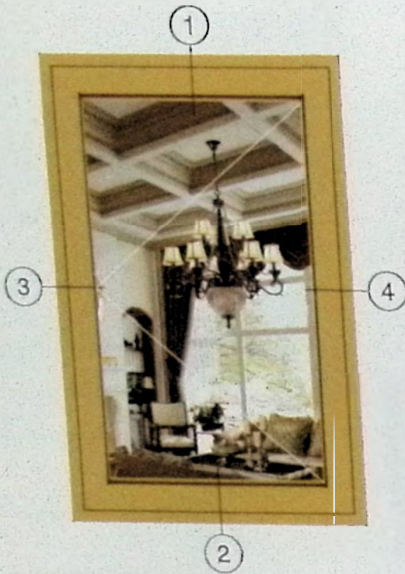

65系列平开门结构图

Structure Diagram of Series 65 Casement Window

永利坚铝材 YONGLIJIAN

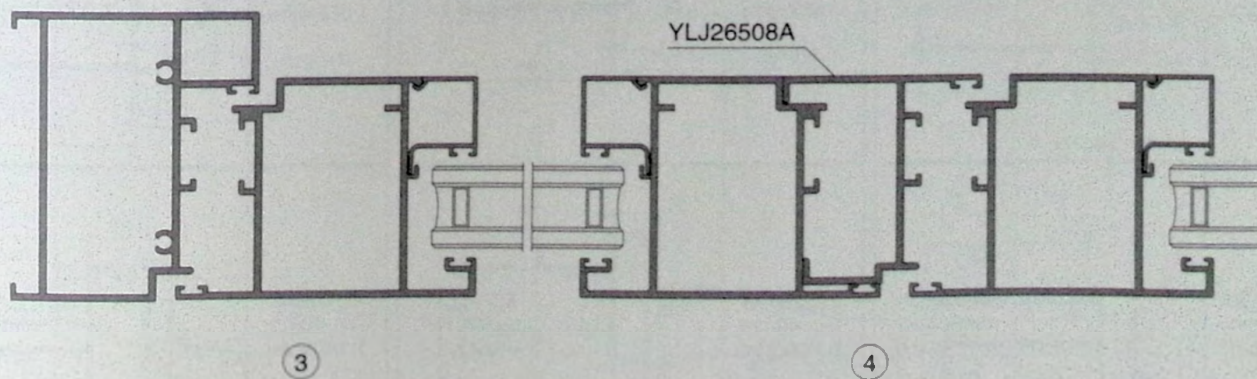
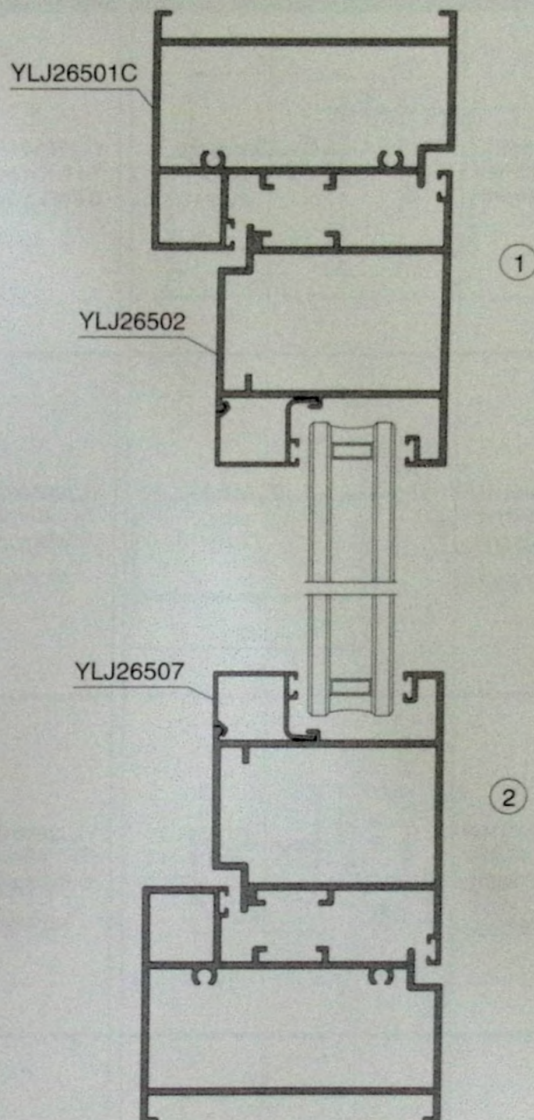
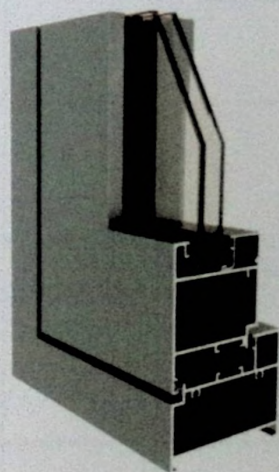
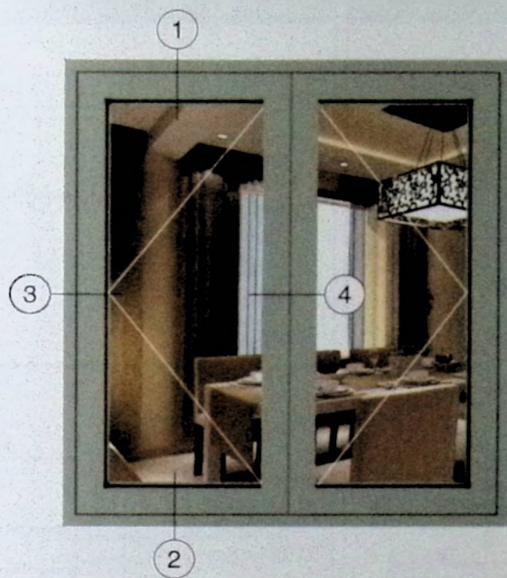



型材型号 米重/kgm	产品图例	型材型号 米重/kgm	产品图例	型材型号 米重/kgm	产品图例
YLJ26501 T=2.00mm 1.513kg/m		YLJ26501A T=1.40mm 0.845kg/m		YLJ26501B T=1.40mm 0.704kg/m	
YLJ26501C T=2.00mm 1.932kg/m		YLJ26501D T=1.40mm 1.006kg/m		YLJ26501E T=1.40mm 0.941kg/m	
YLJ26501F T=1.40mm 0.627kg/m		YLJ26501G T=1.40mm 0.883kg/m		YLJ26501J T=1.40mm 1.220kg/m	
YLJ26501K T=2.00mm 1.295kg/m	 角码配YLJ455A25	YLJ26501L T=2.00mm 0.859kg/m		YLJ26502 T=2.00mm 1.656kg/m	 角码配YLJ455A26
YLJ26502A T=1.40mm 1.125kg/m	 角码配YLJ250B27	YLJ26503 T=1.40mm 1.164kg/m		YLJ26504 T=1.40mm 1.162kg/m	

65系列平开窗型材图

Aluminium Profiles for Series 65 Casement Window

永利坚铝材 YONGLIJIAN



型材型号 米重/kgm	产品图例	型材型号 米重/kgm	产品图例	型材型号 米重/kgm	产品图例
YLJ26504A T=1.40mm 1.315kg/m		YLJ26504B T=1.40mm 0.604kg/m		YLJ26504C T=1.40mm 1.391kg/m	
YLJ26505A T=1.40mm 0.652kg/m		YLJ26506 T=1.00mm 0.170kg/m		YLJ26506A T=1.00mm 0.181kg/m	
YLJ26506B T=1.00mm 0.159kg/m		YLJ26506D T=1.00mm 0.233kg/m		YLJ26507 T=1.20mm 0.233kg/m	
YLJ26507A T=1.20mm 0.234kg/m		YLJ26507B T=1.20mm 0.231kg/m		YLJ26507D T=1.00mm 0.261kg/m	
YLJ26507E T=1.00mm 0.194kg/m		YLJ26508 T=1.40mm 0.870kg/m		YLJ26508A T=2.00mm 0.930kg/m	

注：图中所示为标注厚度的理论重量，实际重量以过磅时的重量为准。



型材型号 米重/kgm	产品图例	型材型号 米重/kgm	产品图例	型材型号 米重/kgm	产品图例
YLJ26509 T=1.20mm 0.243kg/m		YLJ26511 T=1.40mm 1.522kg/m		YLJ26514 T=1.40mm 0.898kg/m	
YLJ26514A T=1.40mm 0.919kg/m		YLJ26515 T=2.00mm 1.725kg/m		YLJ26516 T=2.00mm 1.594kg/m	
YLJ26520 T=1.60mm 0.899kg/m		YLJ26521 T=2.00mm 0.780kg/m			

70系列平开窗结构图

Structure Diagram of Series 70 Casement Window

永利坚铝材 YONGLIJIAN

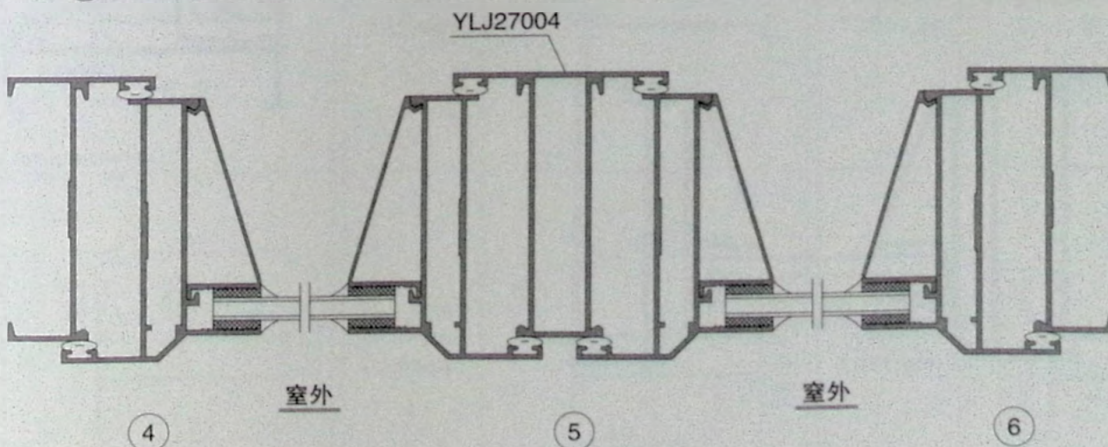
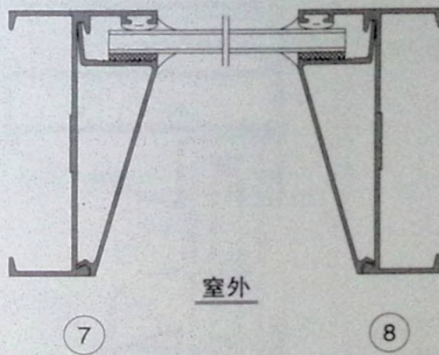
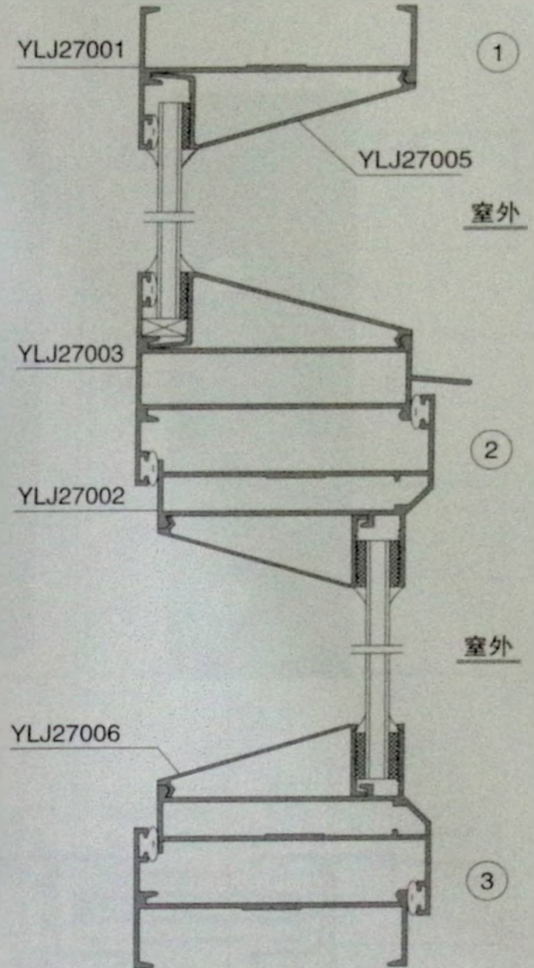
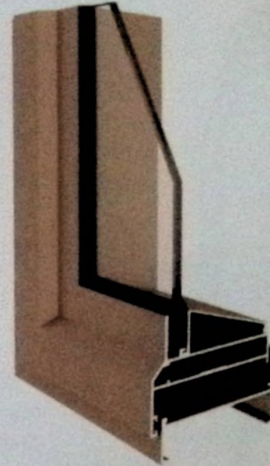
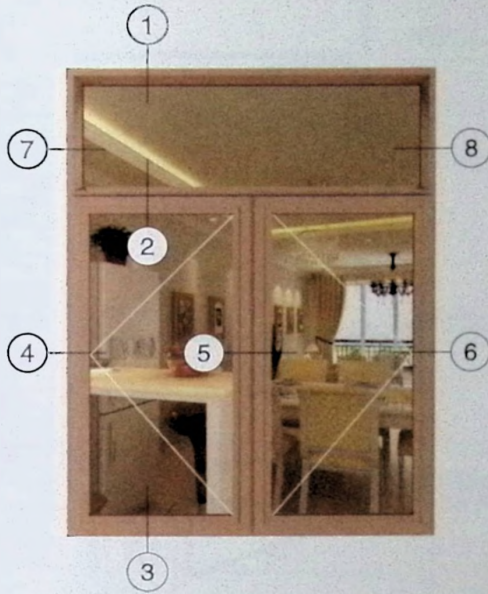

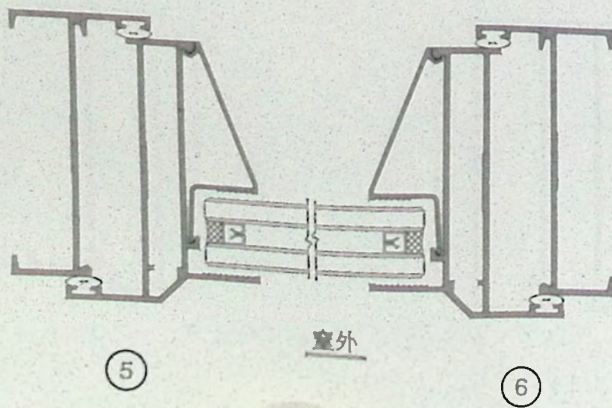
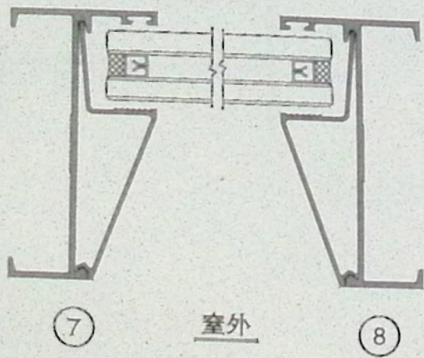
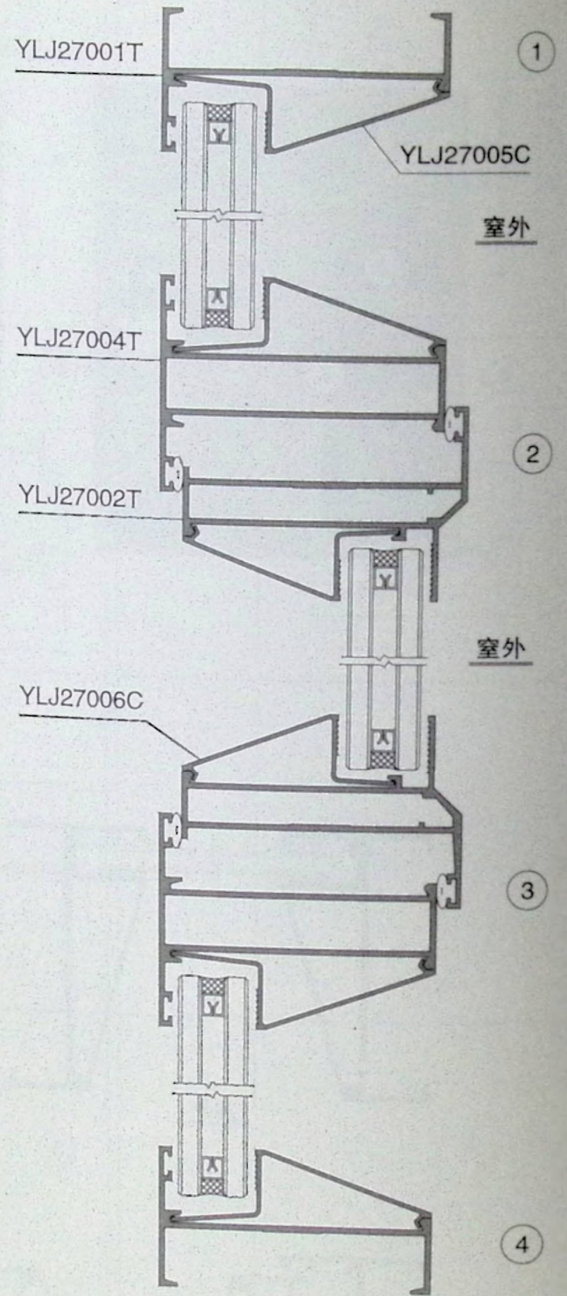
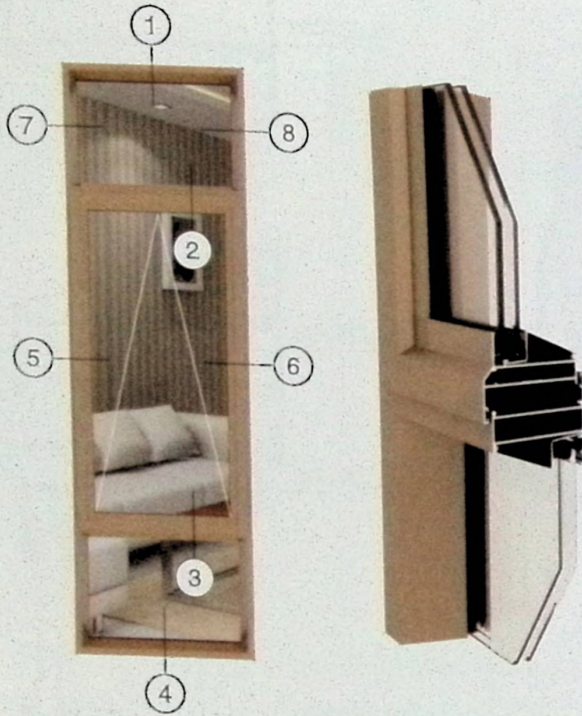

70系列平开窗型材图

Aluminium Profiles for Series 70 Sliding Window

永利坚铝材 YONGLIJIAN



型材型号 米重/kgm	产品图例	型材型号 米重/kgm	产品图例	型材型号 米重/kgm	产品图例
YLJ27001 T=1.26mm 0.533kg/m YLJ27001T T=1.45mm 0.577kg/m		YLJ27001AT T=1.45mm 0.654kg/m		YLJ27001E T=1.40mm 0.676kg/m	
YLJ27001F T=1.40mm 0.676kg/m		YLJ27001H T=2.00mm 1.380kg/m		YLJ27001S T=1.60mm 0.713kg/m	
YLJ27002 T=1.26mm 0.782kg/m YLJ27002T T=1.45mm 0.854kg/m	 角码配YLJ25013D	YLJ27002H T=2.00mm 1.327kg/m	 角码配GRD7210	YLJ27002P T=1.20mm 0.754kg/m	 角码配YLJ70017
YLJ27002S T=1.60mm 0.925kg/m	 角码配YLJ25013D	YLJ27018T T=1.45mm 0.530kg/m		YLJ27003 T=1.26mm 0.901kg/m	
YLJ27004 T=1.26mm 0.850kg/m YLJ27004T T=1.45mm 0.941kg/m		YLJ27004B T=1.20mm 0.820kg/m		YLJ27004H T=2.00mm 1.331kg/m	

注：图中所示为标注厚度的理论重量，实际重量以过磅时的重量为准。



型材型号 米重/kgm	产品图例	型材型号 米重/kgm	产品图例	型材型号 米重/kgm	产品图例
YLJ27004S T=1.60mm 1.013kg/m		YLJ27005 T=1.00mm 0.270kg/m		YLJ27005A T=0.80mm 0.230kg/m	
YLJ27005C T=1.00mm 0.259kg/m		YLJ27005E T=1.00mm 0.294kg/m		YLJ27005B T=1.00mm 0.309kg/m	
YLJ27006 T=0.80mm 0.206kg/m		YLJ27006A T=0.80mm 0.201kg/m		YLJ27006B T=1.00mm 0.271kg/m	
YLJ27006C T=1.00mm 0.221kg/m		YLJ27006E T=1.00mm 0.254kg/m		YLJ27015 T=1.00mm 0.243kg/m	
YLJ27021A T=0.90mm 0.258kg/m		YLJ27024 T=0.90mm 0.252kg/m		YLJ27014 T=1.00mm 0.268kg/m	

注：图中所示为标注厚度的理论重量，实际重量以过磅时的重量为准。

70系列平开窗型材图

Aluminium Profiles for Series 70 Sliding Window

永利坚铝材 YONGLIJIAN



型材型号 米重/kgm	产品图例	型材型号 米重/kgm	产品图例	型材型号 米重/kgm	产品图例
YLJ27021 T=0.90mm 0.301kg/m		YLJ27023 T=0.90mm 0.295kg/m		YLJ27007AT T=1.45mm 1.222kg/m	
YLJ27007S T=1.60mm 1.283kg/m		YLJ27007T T=1.45mm 1.175kg/m		YLJ27008 T=1.26mm 0.748kg/m	
YLJ27008AT T=3.00mm 0.687kg/m		YLJ27022 T=3.00mm 0.316kg/m			

注：图中所示为标注厚度的理论重量，实际重量以过磅时的重量为准。

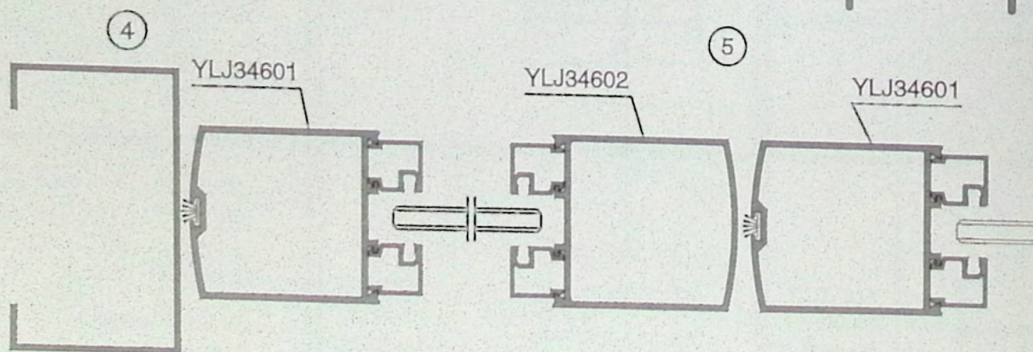
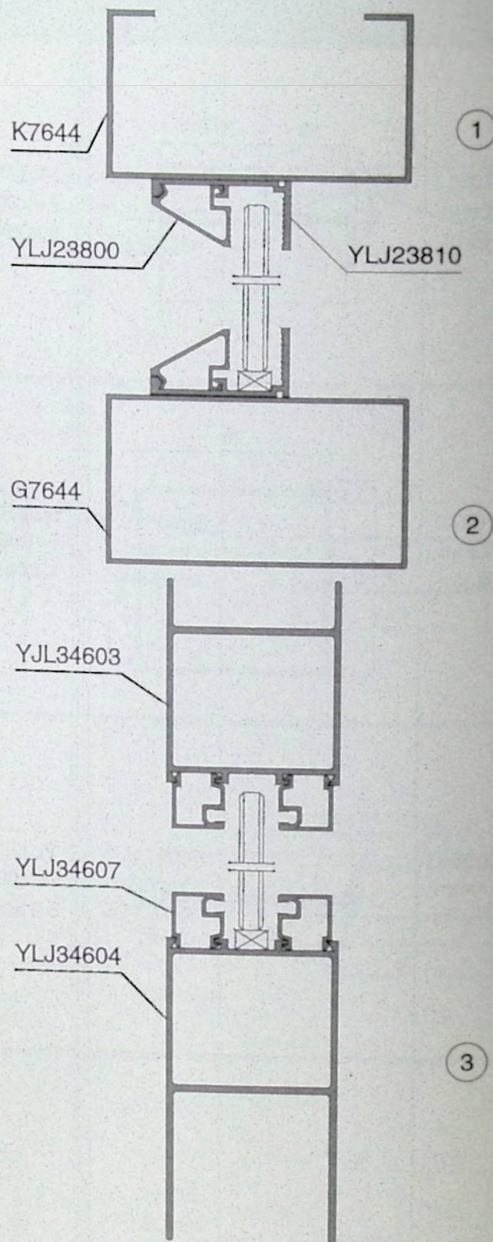
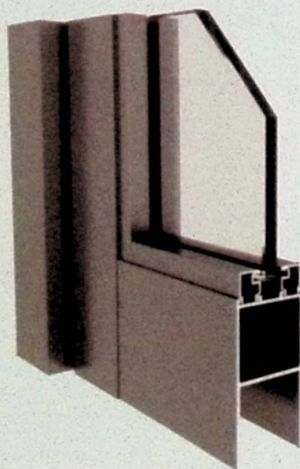
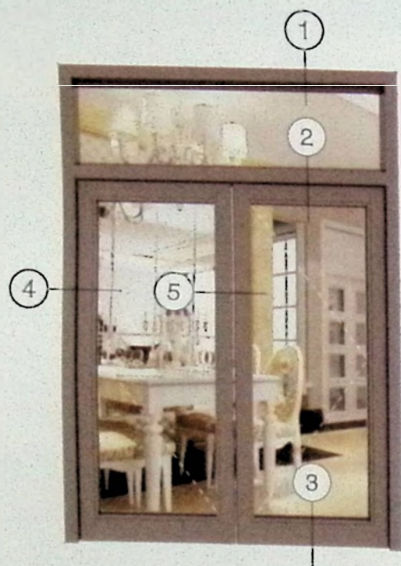

46系列地弹门型材图

Aluminium Profiles for Series 46 Spring Door

永利坚铝材 YONGLIJIAN



型号厚度 米重/kgm	产品图例	型号厚度 米重/kgm	产品图例	型号厚度 米重/kgm	产品图例
YLJ34601 T=1.50mm 0.832kg/m		YLJ34601E T=2.50mm 1.743kg/m		YLJ34602 T=1.50mm 0.802kg/m	
YLJ34601P T=1.20mm 0.694kg/m				YLJ34602P T=1.20mm 0.661kg/m	
YLJ34601H T=2.00mm 1.066kg/m				YLJ34602H T=2.00mm 1.033kg/m	
YLJ34603 T=1.50mm 0.844kg/m		YLJ34603B T=2.00mm 1.031kg/m		YLJ34603E T=2.50mm 1.608kg/m	
YLJ34603P T=1.20mm 0.708kg/m					
YLJ34603H T=2.00mm 1.061kg/m					
YLJ34604 T=1.50mm 1.064kg/m		YLJ34604B T=2.00mm 1.424kg/m		YLJ34604E T=2.50mm 1.642kg/m	
YLJ34604P T=1.30mm 0.981kg/m					
YLJ34605 T=2.50mm 1.426kg/m		YLJ34606 T=0.90mm 0.122kg/m		YLJ34606B T=0.90mm 0.136kg/m	
YLJ34607 T=0.90mm 0.140kg/m		YLJ34608 T=3.20mm 2.433kg/m		YLJ34609 T=1.30mm 1.020kg/m	

注：图中所示为标注厚度的理论重量，实际重量以过磅时的重量为准。



型号厚度 米重/kgm	产品图例	型号厚度 米重/kgm	产品图例	型号厚度 米重/kgm	产品图例
YLJ34609B T=2.00mm 1.404kg/m		YLJ34610 T=1.60mm 1.180kg/m YLJ34610A T=2.10mm 1.503kg/m YLJ34621 T=3.00mm 2.079kg/m		YLJ34611 T=1.60mm 1.577kg/m	
YLJ34611H T=2.00mm 1.970kg/m		YLJ34611A T=1.60mm 0.549kg/m		YLJ34612 T=1.00mm 0.110kg/m	
YLJ34613 T=1.60mm 1.141kg/m YLJ34613A T=2.10mm 1.468kg/m		YLJ34614 T=1.80mm 1.549kg/m		YLJ34615 T=1.80mm 1.215kg/m YLJ34615P T=1.60mm 1.092kg/m	
YLJ34617 T=1.80mm 0.400kg/m		YLJ34618A T=2.50mm 3.273kg/m		YLJ34620 T=0.80mm 0.132kg/m	
YLJ34622 T=3.00mm 2.042kg/m		YLJ34623 T=1.10mm 0.151kg/m		YLJ34623A T=1.10mm 0.138kg/m	

46系列地弹门型材图

Aluminium Profiles for Series 46 Spring Door

永利坚铝材 YONGLIJIAN



型号厚度 米重/kgm	产品图例	型号厚度 米重/kgm	产品图例	型号厚度 米重/kgm	产品图例
YLJ34624 T=3.00mm 2.031kg/m YLJ34624H T=2.00mm 1.399kg/m		YLJ34624A T=2.10mm 1.418kg/m		YLJ34625 T=1.00mm 0.123kg/m	
YLJ34625A T=1.00mm 0.129kg/m		YLJ34626 T=2.00mm 1.622kg/m		YLJ34627 T=2.00mm 1.57kg/m	
YLJ34628 T=0.90mm 0.114kg/m		YLJ34633 T=1.80mm 1.236kg/m		YLJ34652 T=2.00mm 1.781kg/m	
YLJ34653 T=2.00mm 1.126kg/m		YLJ34654 T=1.40mm 0.254kg/m		YLJ34655 T=2.00mm 1.303kg/m	
YLJ34656 T=1.60mm 0.684kg/m		YLJ34657 T=2.00mm 1.608kg/m		YLJ34657A T=2.00mm 1.608kg/m	

注：图中所示为标注厚度的理论重量，实际重量以过磅时的重量为准。



型号厚度 米重/kgm	产品图例	型号厚度 米重/kgm	产品图例	型号厚度 米重/kgm	产品图例
YLJ34659 T=2.00mm 1.595kg/m		YLJ34660 T=1.80mm 1.738kg/m		YLJ34661 T=1.20mm 0.225kg/m	
YLJ34662 T=1.00mm 0.130kg/m		YLJ34678 T=1.00mm 0.118kg/m		YLJ34682 T=1.50mm 0.397kg/m	
YLJ34686 T=1.10mm 0.148kg/m		YLJ34689 T=3.00mm 1.713kg/m		YLJ34690 T=3.00mm 1.661kg/m	
YLJ34691 T=2.00mm 1.080kg/m		YLJ34692 T=3.00mm 4.102kg/m		YLJ34693 T=1.60mm 0.989kg/m	
YLJ34694 T=1.60mm 0.980kg/m		YLJ34695 T=0.80mm 0.105kg/m		YLJ34699 T=0.90mm 0.142kg/m	

注：图中所示为标注厚度的理论重量，实际重量以过磅时的重量为准。

50系列平开门(窗)结构图

Structure Diagram of Series 50 Casement Door(Window)

永利坚铝材 YONGLIJIAN

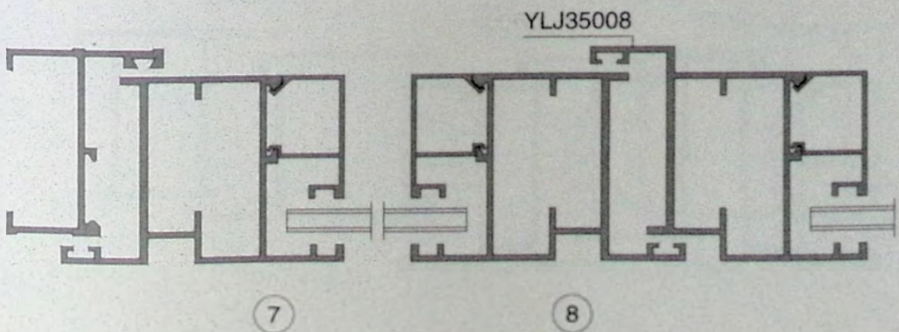
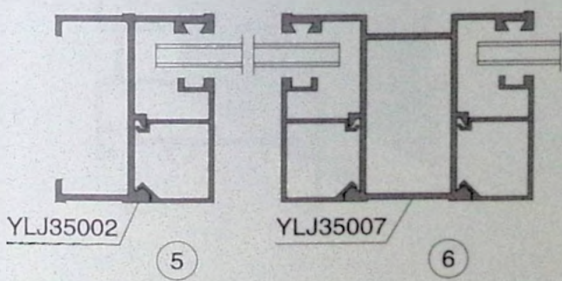
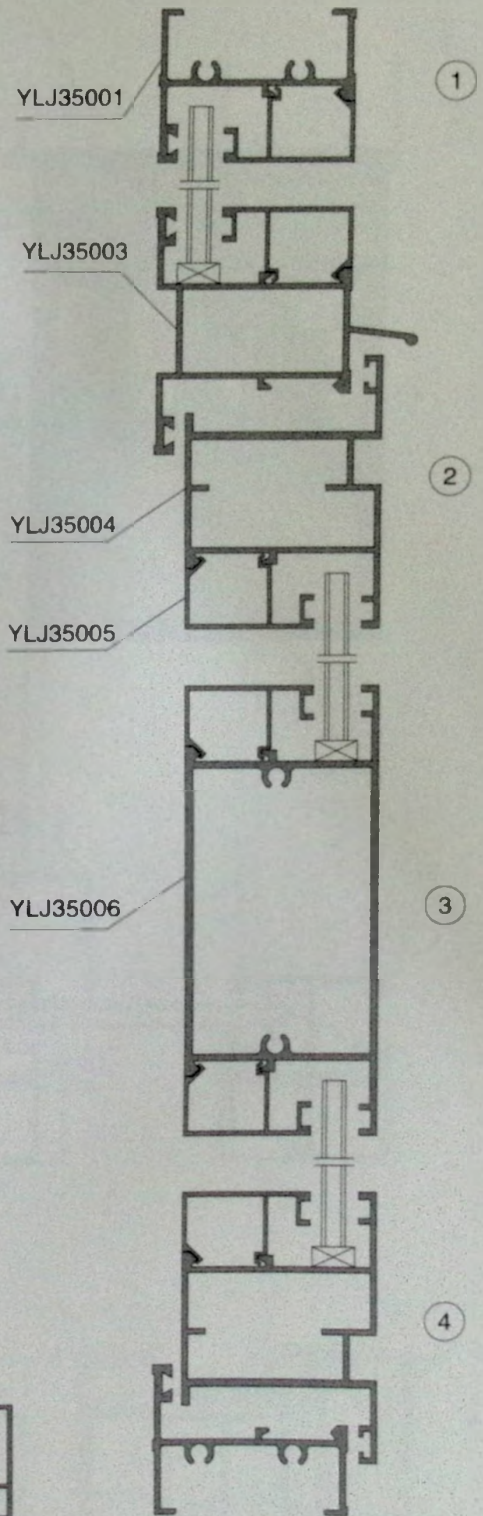
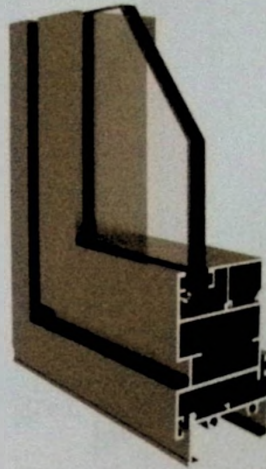
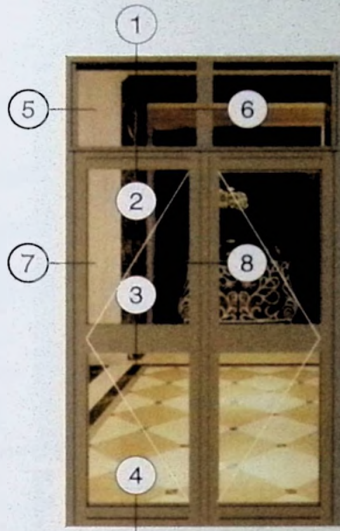

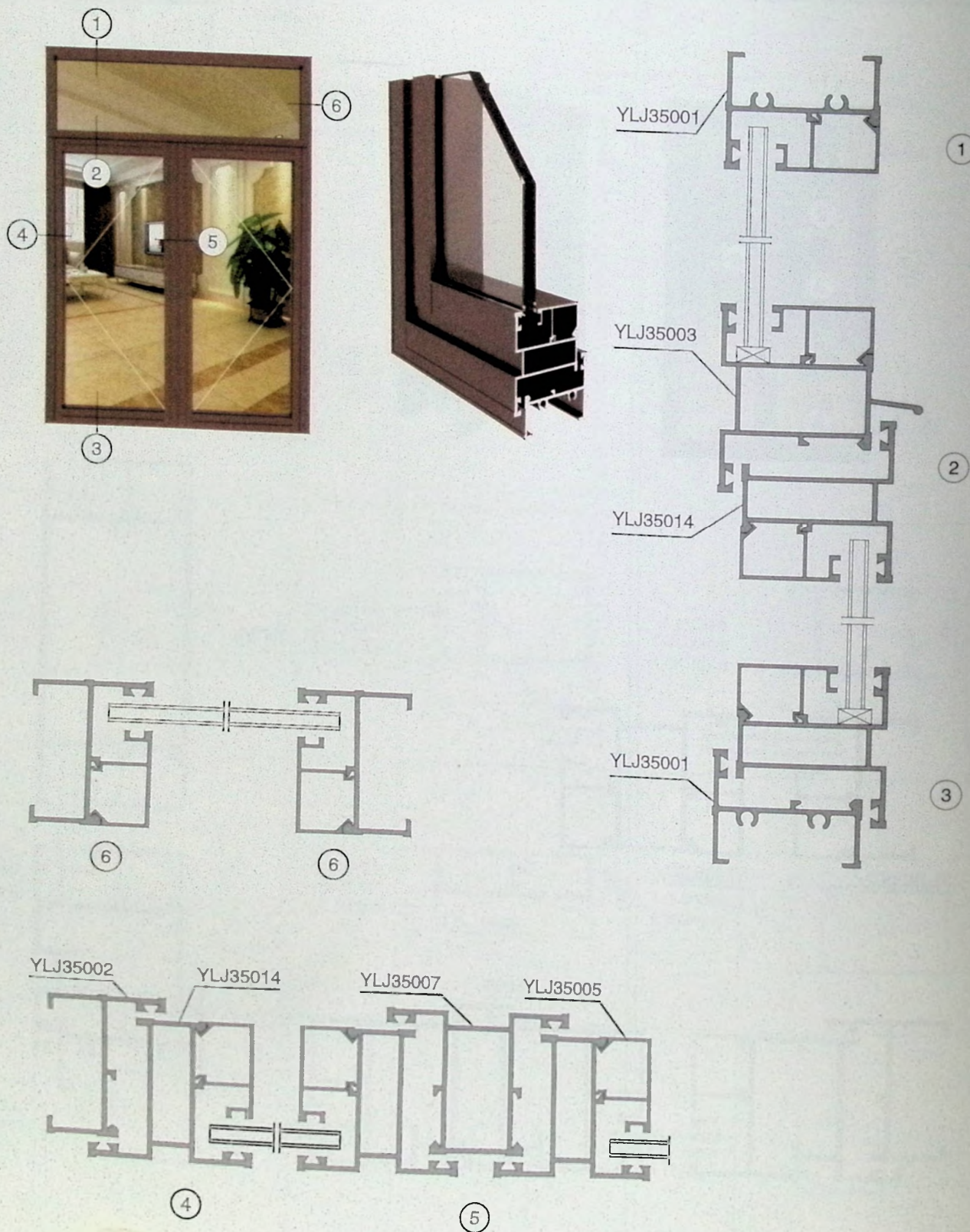

50系列平开门(窗)结构图

Structure Diagram of Series 50 Casement Door(Window)

永利坚铝材 YONGLIJIAN

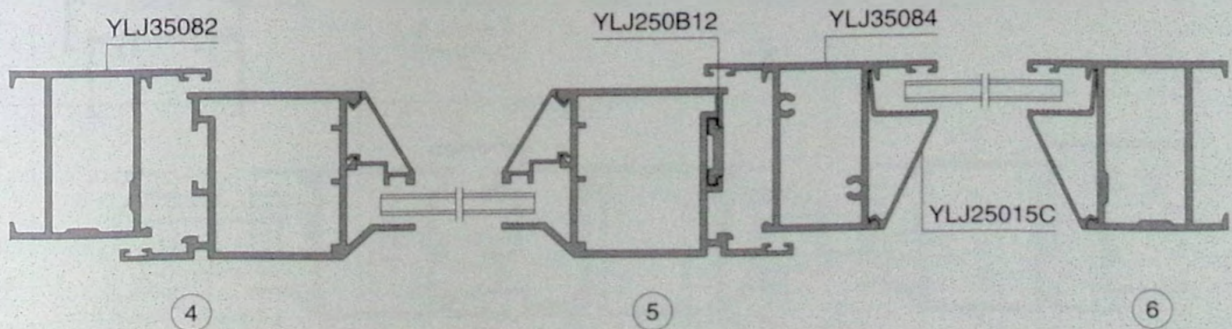
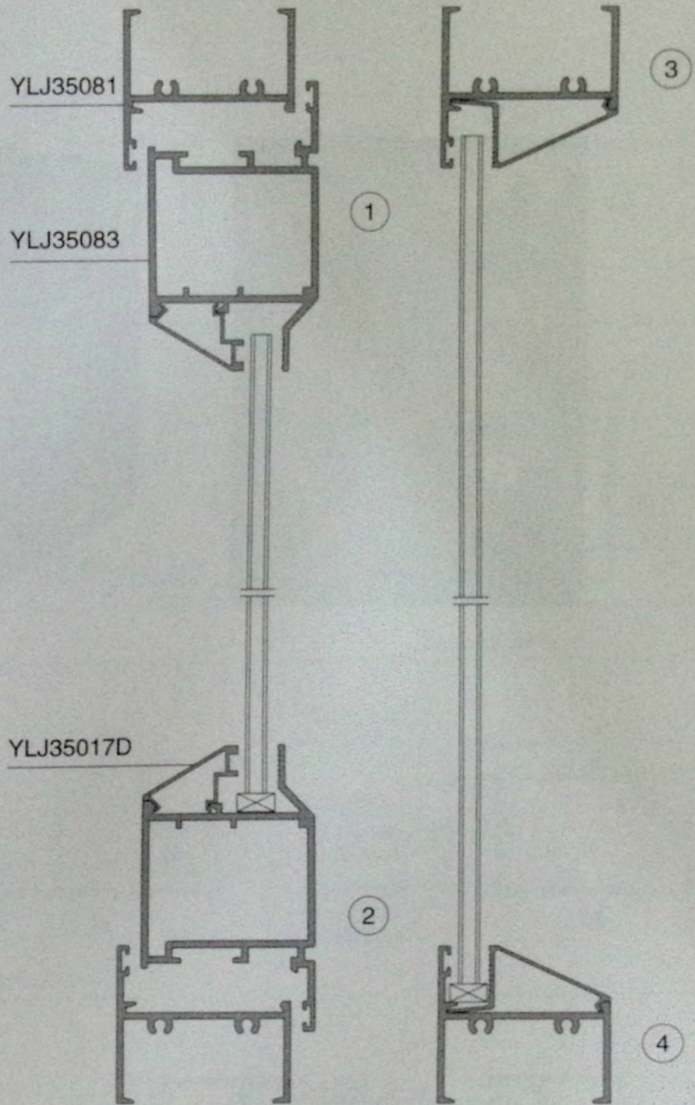
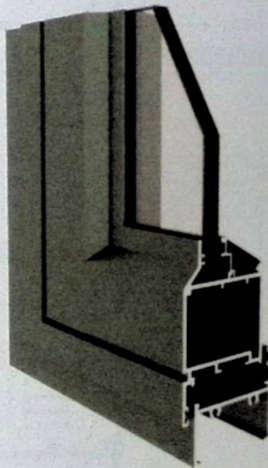
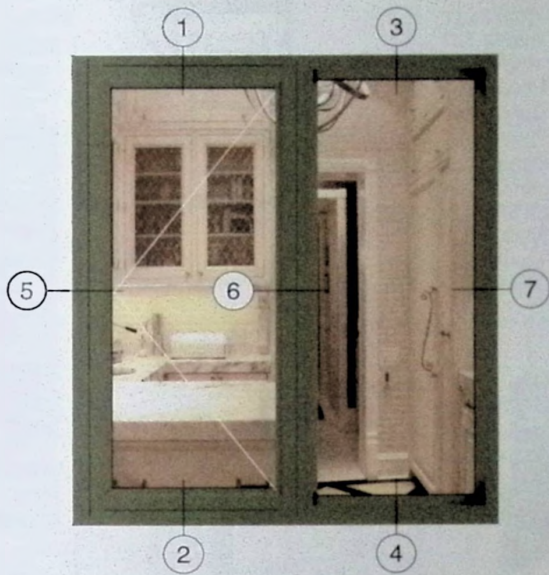
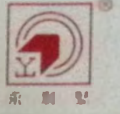

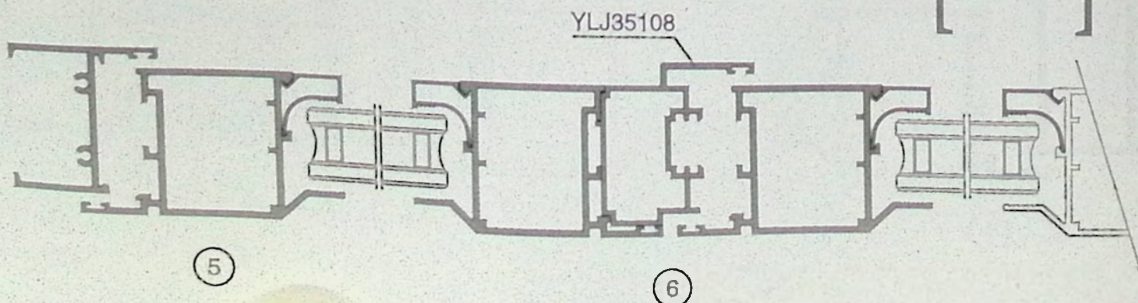
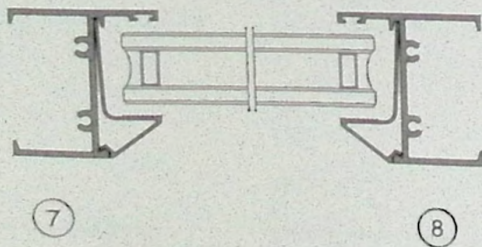
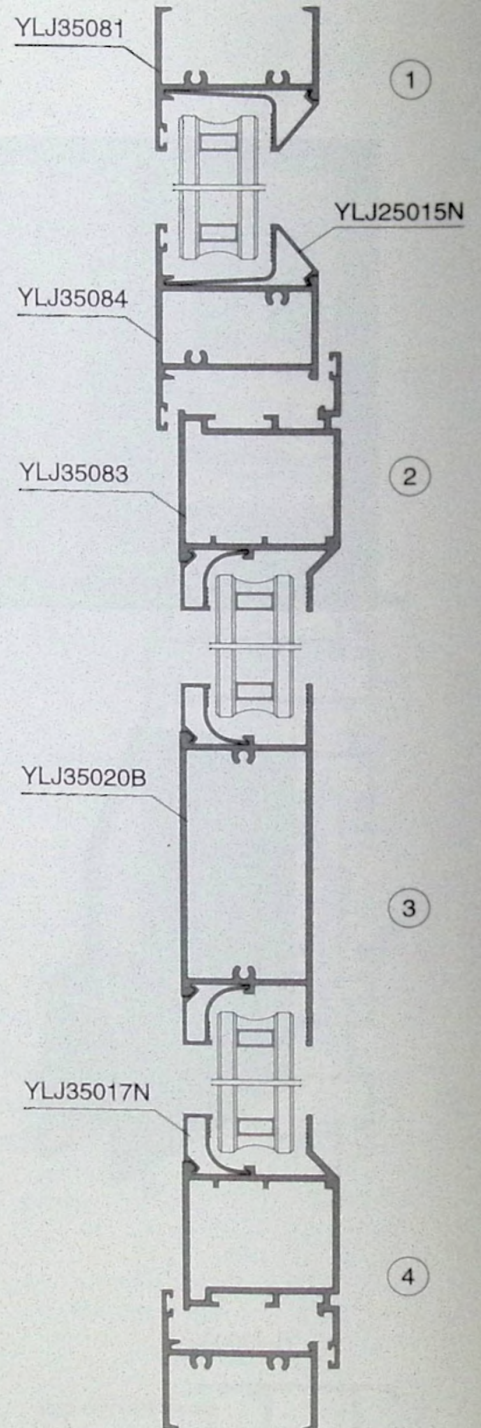
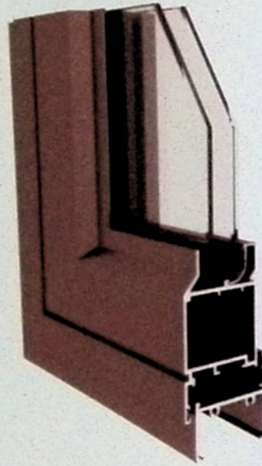
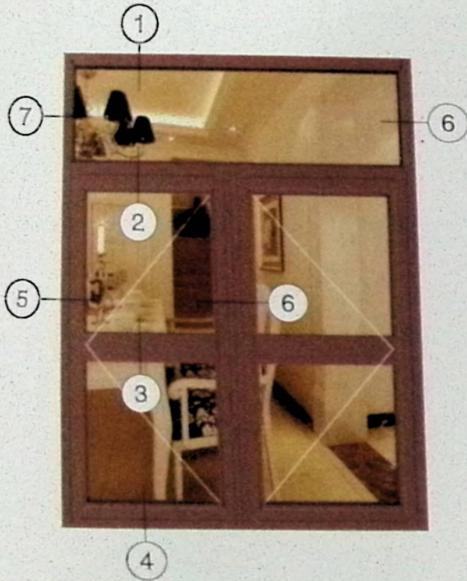

50系列平开门型材图

Aluminium Profiles for Series 50 Casement Door

永利坚铝材 YONGLIJIAN



型号厚度 米重/kgm	产品图例	型号厚度 米重/kgm	产品图例	型号厚度 米重/kgm	产品图例
YLJ35001 T=1.50mm 0.674kg/m YLJ35001P T=1.20mm 0.592kg/m YLJ35001T T=2.00mm 0.812kg/m		YLJ35002 T=1.50mm 0.578kg/m YLJ35002P T=1.20mm 0.496kg/m YLJ35002T T=2.00mm 0.717kg/m YLJ35002W T=1.35mm 0.549kg/m		YLJ35002A T=1.40mm 0.533kg/m	
YLJ35003 T=1.50mm 1.056kg/m YLJ35003H T=2.00mm 1.284kg/m		YLJ35003AH T=2.00mm 1.362kg/m		YLJ35004 T=1.50mm 1.096kg/m YLJ35004H T=2.00mm 1.278kg/m	
YLJ35004A T=1.50mm 1.135kg/m		YLJ35004B T=1.40mm 1.021kg/m		YLJ35006 T=2.00mm 1.721kg/m YLJ35006T T=1.40mm 1.402kg/m YLJ35006P T=1.20mm 1.259kg/m	
YLJ35007 T=1.50mm 0.970kg/m YLJ35007H T=2.00mm 1.195kg/m YLJ35007T T=1.40mm 0.934kg/m YLJ35007P T=1.20mm 0.856kg/m YLJ35007W T=1.35mm 0.912kg/m		YLJ35007A T=1.20mm 0.967kg/m YLJ35007AT T=1.40mm 1.039kg/m YLJ35007AH T=2.00mm 1.258kg/m		YLJ35008 T=1.50mm 1.090kg/m YLJ35008H T=2.00mm 1.278kg/m	
YLJ35014 T=1.50mm 0.884kg/m YLJ35014T T=2.00mm 1.053kg/m YLJ35014P T=1.20mm 0.734kg/m YLJ35014W T=1.35mm 0.810kg/m		YLJ35014AP T=1.20mm 0.829kg/m		YLJ35020 T=1.80mm 1.623kg/m	

注：图中所示为标注厚度的理论重量，实际重量以过磅时的重量为准。



型号厚度 米重/kgm	产品图例	型号厚度 米重/kgm	产品图例	型号厚度 米重/kgm	产品图例
YLJ35020B T=1.90mm 1.626kg/m		YLJ35022 T=1.40mm 0.486kg/m		YLJ35081 T=1.90mm 0.785kg/m	
YLJ35081A T=2.00mm 1.279kg/m		YLJ35082 T=1.90mm 1.089kg/m		YLJ35083 T=2.00mm 1.395kg/m	 角码配YLJ455M09
YLJ35083D T=2.00mm 1.420kg/m	 角码配YLJ455M09	YLJ35084 T=1.90mm 1.160kg/m		YLJ35084A T=2.00mm 1.501kg/m	
YLJ35086 T=2.00mm 1.506kg/m		YLJ35091 T=2.00mm 0.937kg/m		YLJ35092 T=2.00mm 1.686kg/m	
YLJ35086A T=1.40mm 1.164kg/m		YLJ35095 T=2.00mm 1.201kg/m		YLJ35098 T=2.00mm 1.805kg/m	
YLJ35093 T=2.00mm 1.124kg/m					

50系列平开门型材图

Aluminium Profiles for Series 50 Casement Door

永利坚铝材 YONGLIJIAN



型号厚度 米重/kgm	产品图例	型号厚度 米重/kgm	产品图例	型号厚度 米重/kgm	产品图例
YLJ35099 T=2.00mm 1.122kg/m		YLJ350113W T=1.35mm 0.373kg/m		YLJ350120 T=1.40mm 0.310kg/m	
YLJ35005 T=1.00mm 0.263kg/m		YLJ35012 T=1.00mm 0.214kg/m		YLJ35017 T=0.90mm 0.175kg/m	
YLJ35017A T=0.80mm 0.157kg/m		YLJ35017B T=1.00mm 0.178kg/m		YLJ35017C T=1.00mm 0.218kg/m	
YLJ35017D T=1.00mm 0.187kg/m		YLJ35017E T=0.80mm 0.157kg/m		YLJ35017F T=0.80mm 0.139kg/m	
YLJ35017G T=0.90mm 0.168kg/m		YLJ35017K T=1.00mm 0.170kg/m		YLJ35017N T=1.00mm 0.162kg/m	

注：图中所示为标注厚度的理论重量，实际重量以过磅时的重量为准。



型号厚度 米重/kgm	产品图例	型号厚度 米重/kgm	产品图例	型号厚度 米重/kgm	产品图例
YLJ35085 T=1.00mm 0.178kg/m		YLJ35085A T=1.00mm 0.167kg/m		YLJ35090 T=0.90mm 0.163kg/m	
YLJ35104A T=1.10mm 0.219kg/m		YLJ35104B T=1.10mm 0.174kg/m		YLJ35105 T=2.00mm 1.697kg/m	
YLJ35106 T=2.00mm 0.453kg/m		YLJ35108 T=1.60mm 0.998kg/m		YLJ35108A T=1.40mm 0.779kg/m	
YLJ350119 T=1.00mm 0.221kg/m		YLJ350122 T=1.60mm 1.240kg/m		YLJ350123 T=1.60mm 0.978kg/m	
YLJ350124 T=3.00mm 2.587kg/m		YLJ350125 T=1.40mm 0.375kg/m		YLJ350127 T=0.90mm 0.181kg/m	

50系列平开门型材图

Aluminium Profiles for Series 50 Casement Door

永利坚铝材 YONGLIJIAN



型号厚度 米重/kgm	产品图例	型号厚度 米重/kgm	产品图例	型号厚度 米重/kgm	产品图例
YLJ350128 T=1.00mm 0.203kg/m		YLJ35017H T=1.00mm 0.174kg/m		YLJ35081G T=3.00mm 0.994kg/m	
YLJ35082B T=2.00mm 0.728kg/m		YLJ35083E T=2.00mm 1.400kg/m	 角码配YLJ455M09	YLJ35083F T=2.00mm 1.280kg/m	 角码配YLJ455A26
YLJ35083G T=3.00mm 1.778kg/m	 角码配LMC68115				

注：图中所示为标注厚度的理论重量，实际重量以过磅时的重量为准。

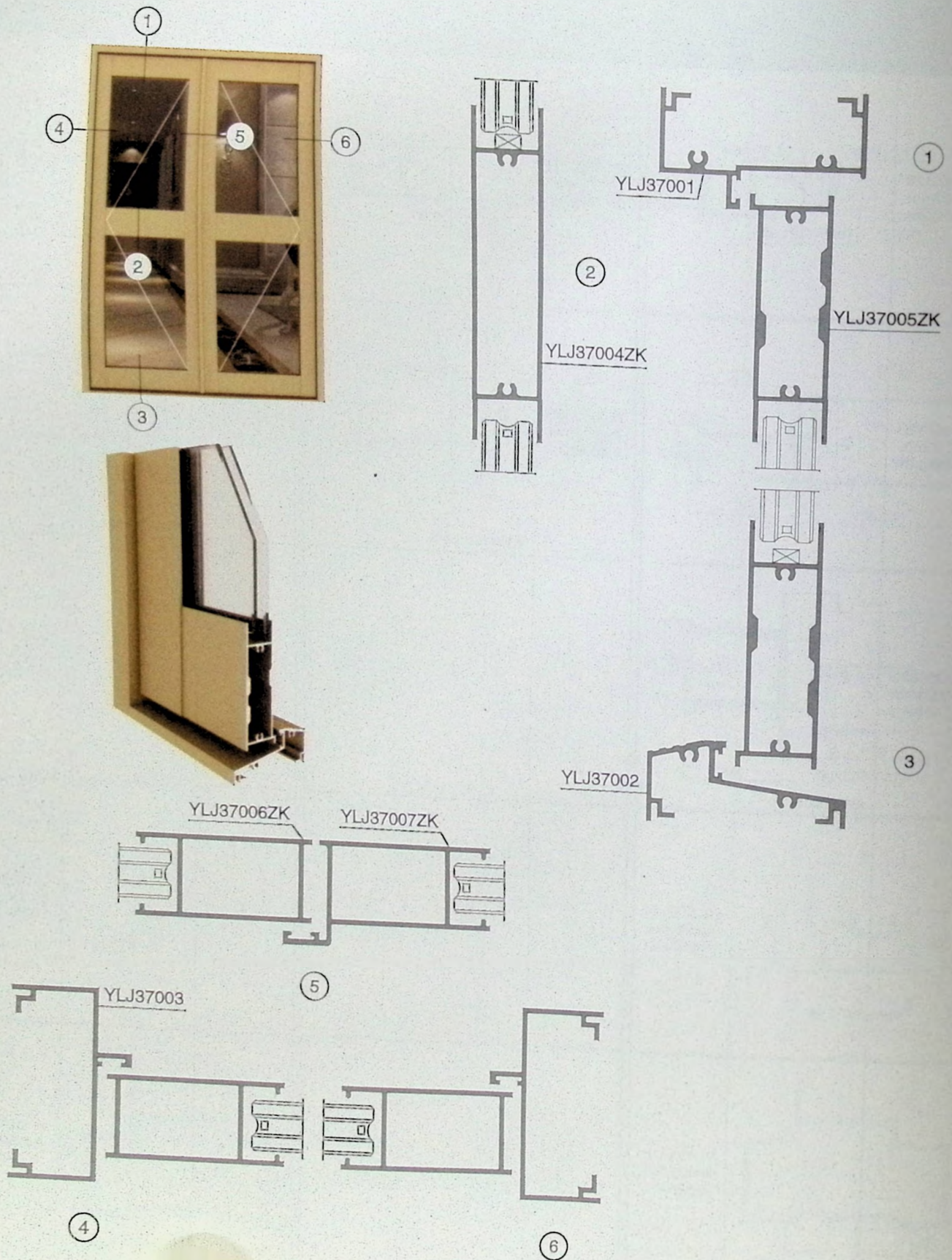

70系列平开门结构图(中空)
Structure Diagram of Series 70 Casement Door(Hollow)

永利坚铝材 YONGLIJIAN

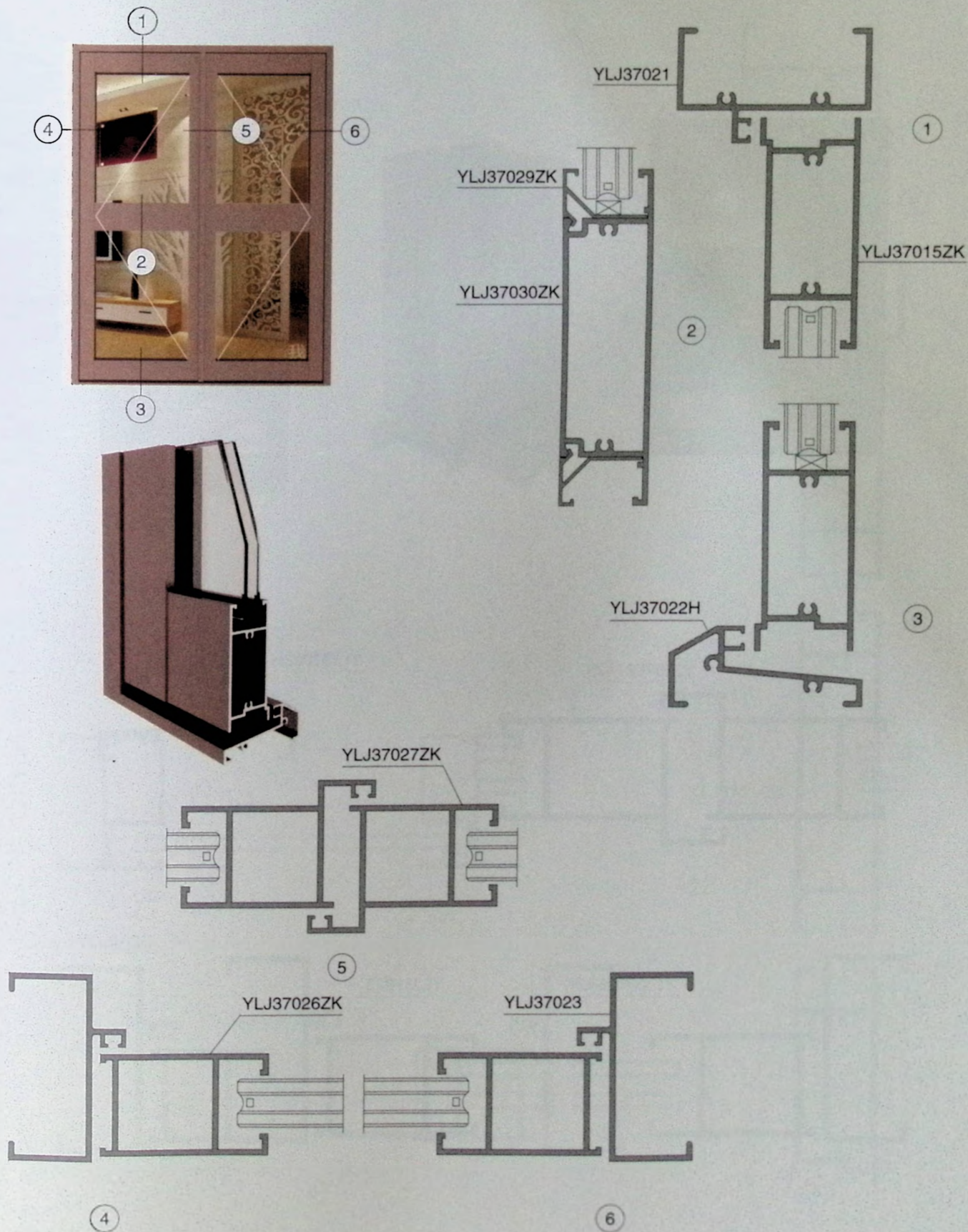

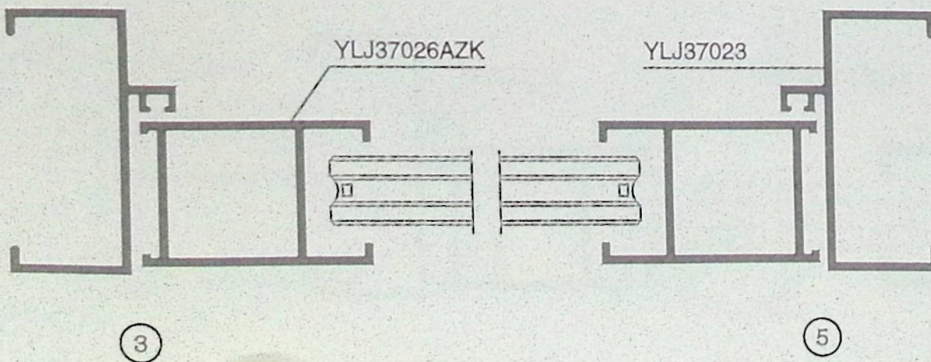
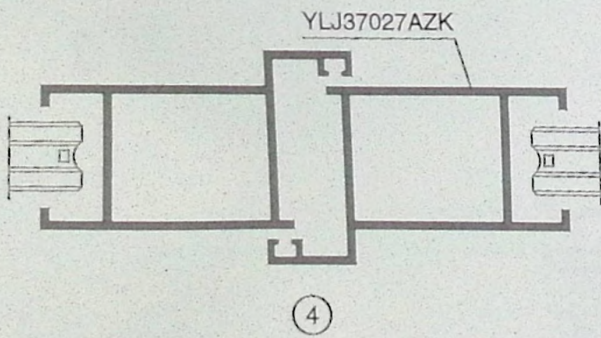
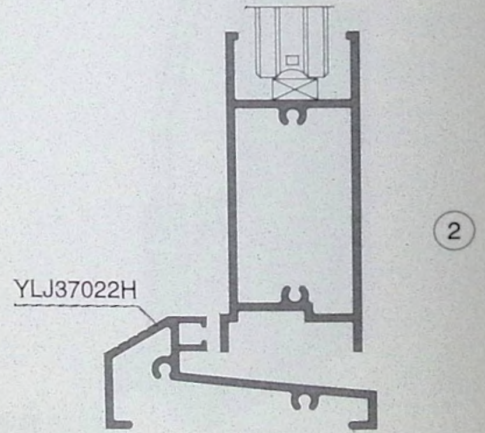
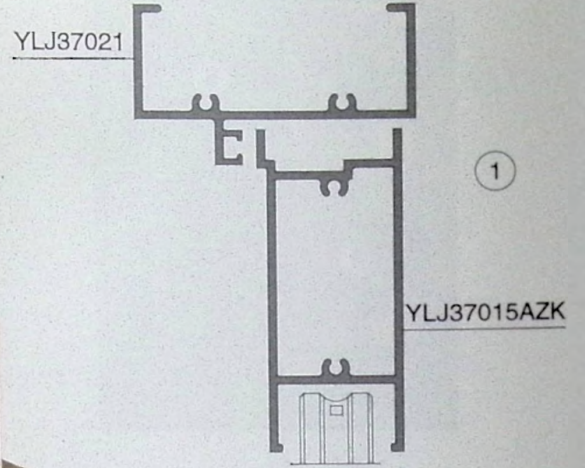
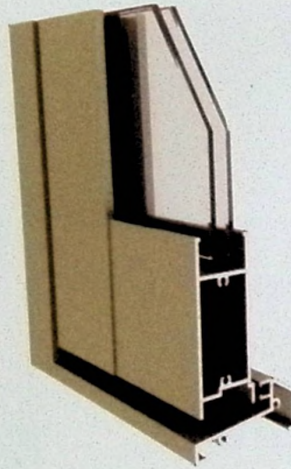

70系列平开门结构图

Structure Diagram of Series 70 Casement Door

永利坚铝材 YONGLIJIAN

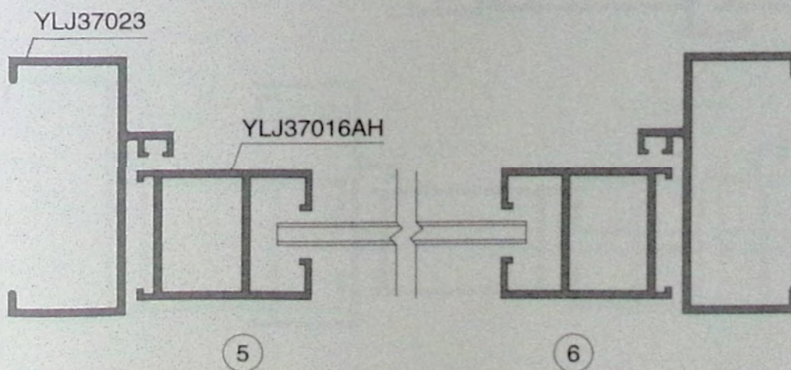
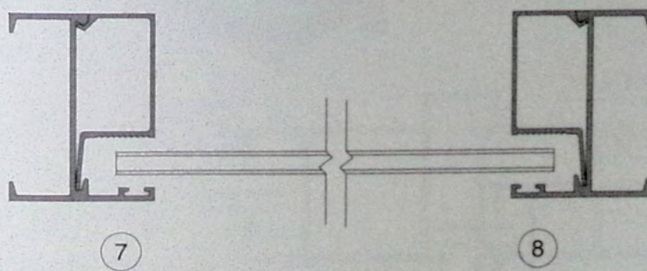
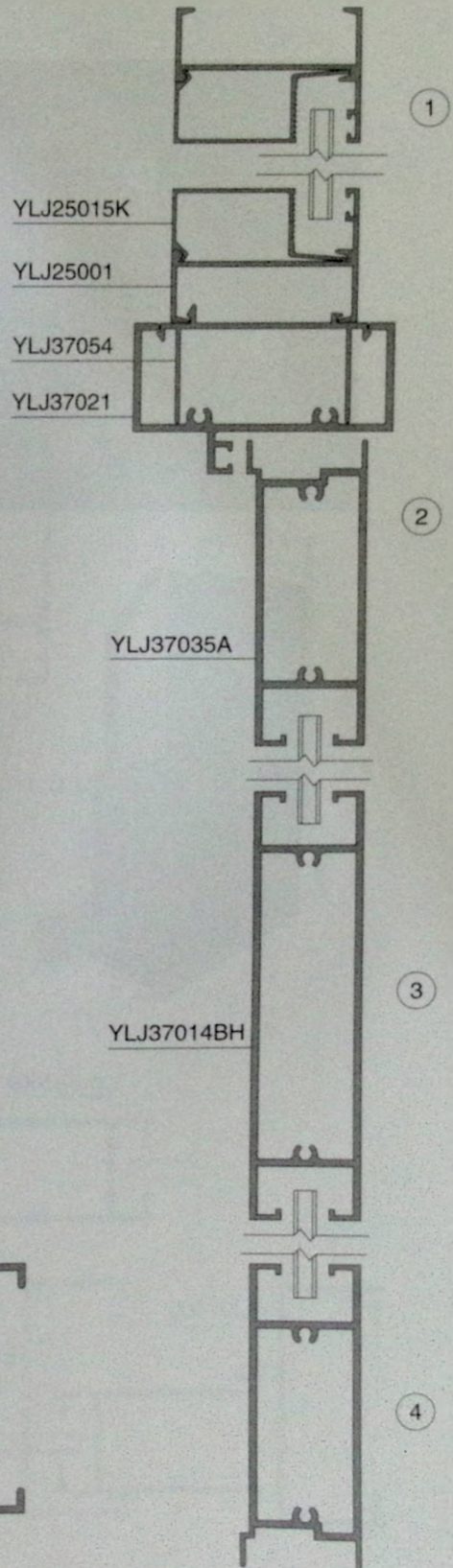
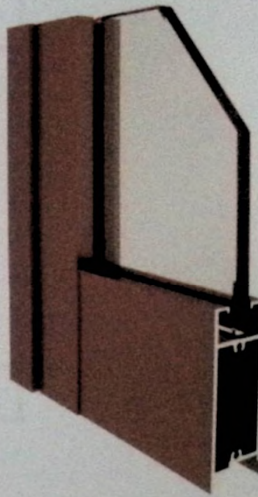
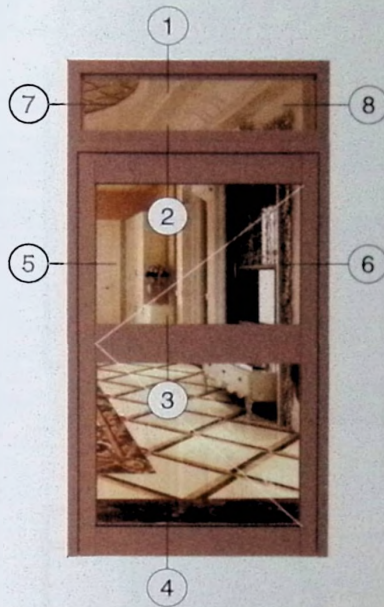

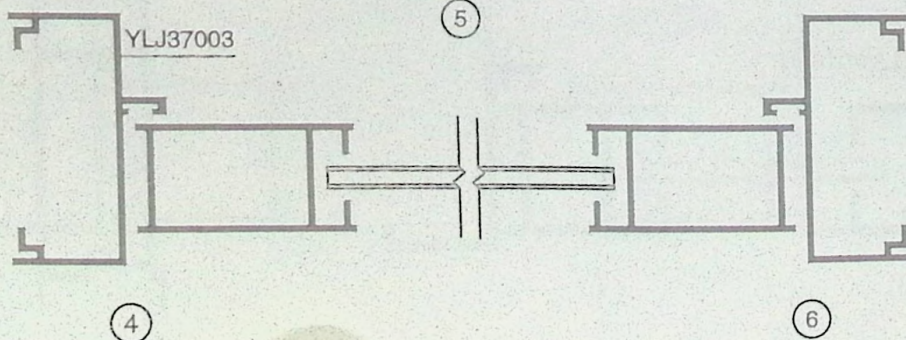
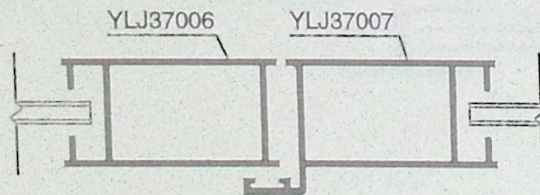
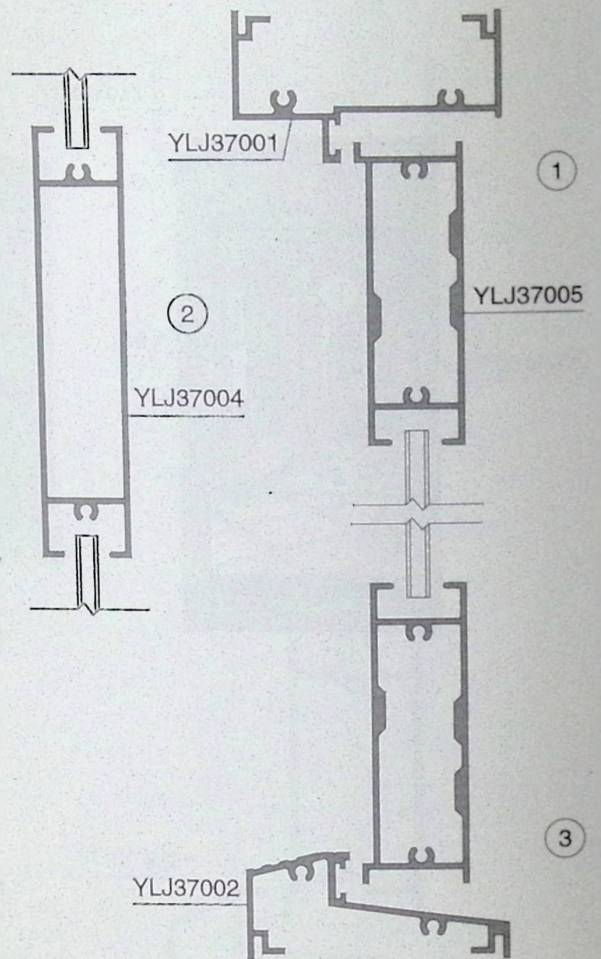
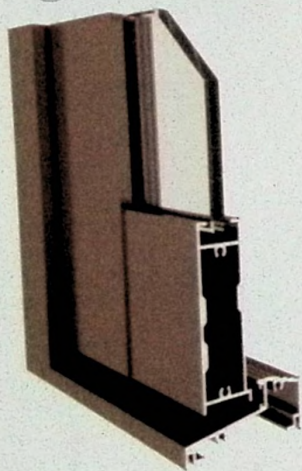
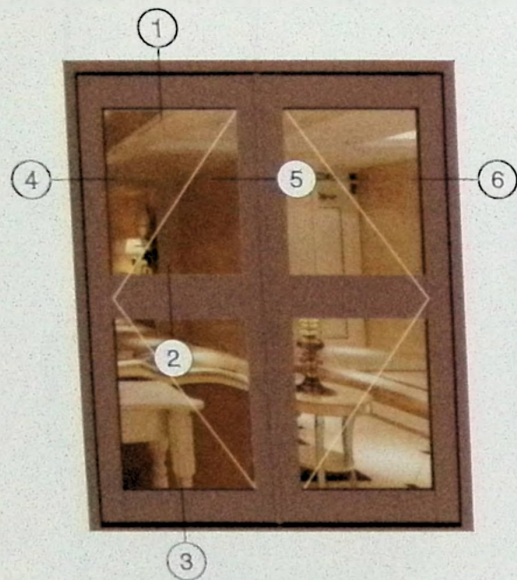

70系列平开门结构图

Structure Diagram of Series 70 Casement Door

永利坚铝材 YONGLIJIAN

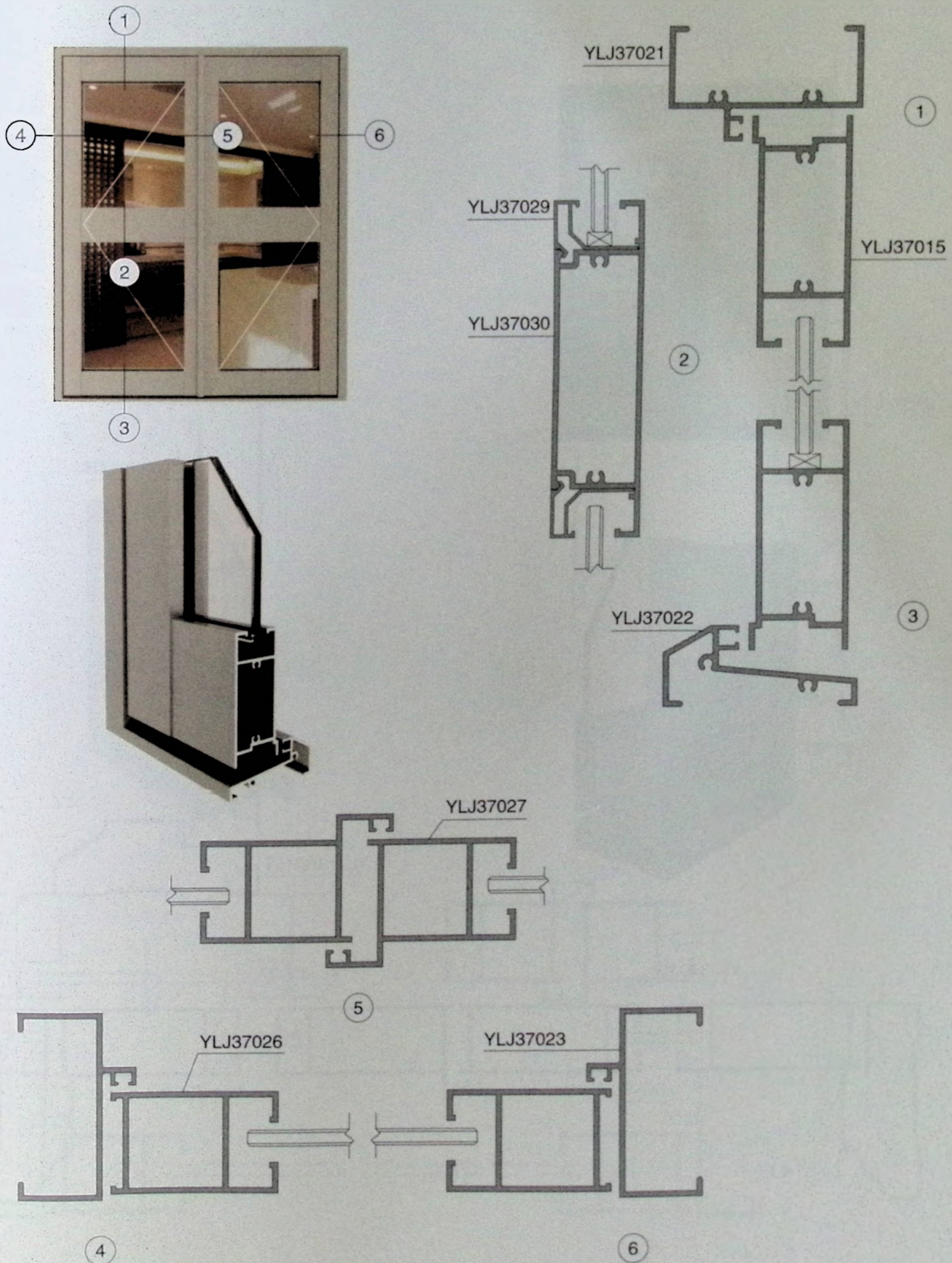

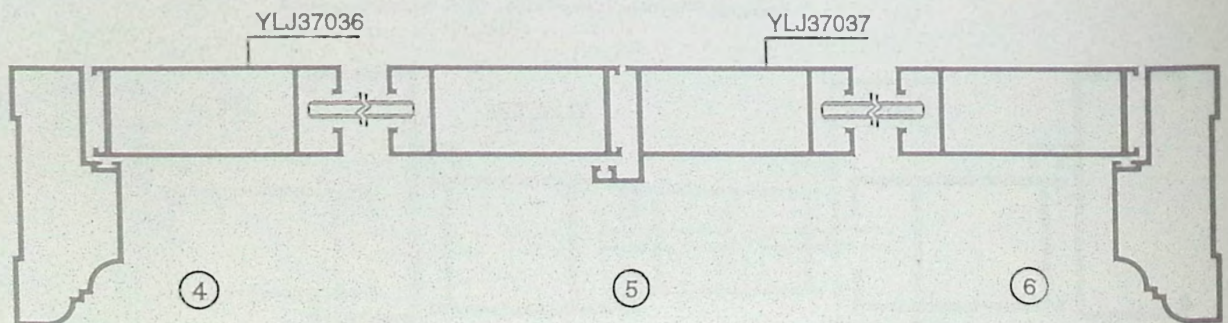
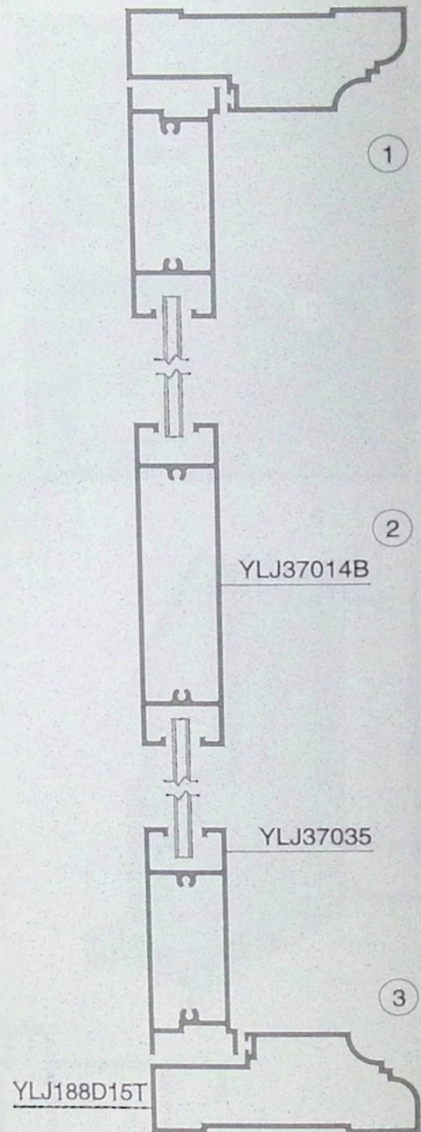
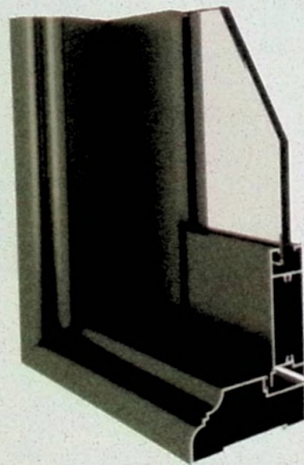
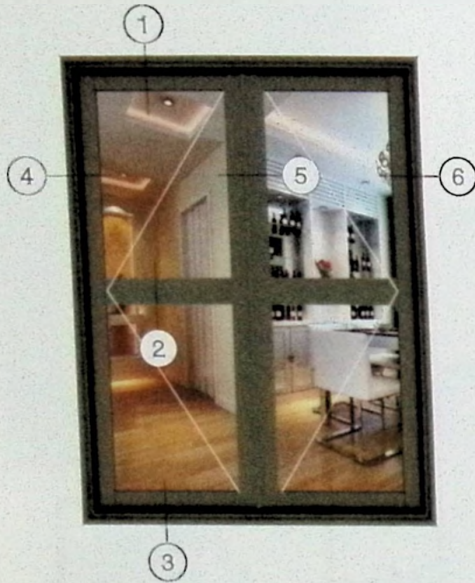

70系列平开门结构图

Structure Diagram of Series 70 Casement Door

永利坚铝材 YONGLIJIAN

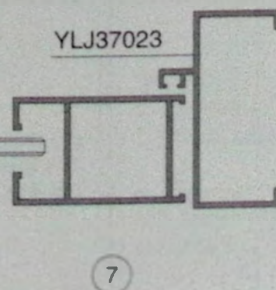
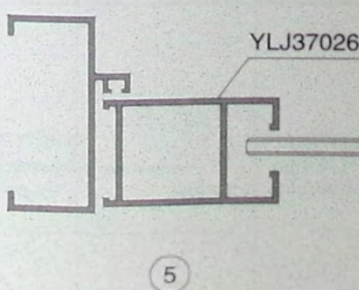
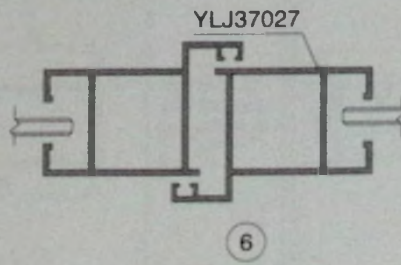
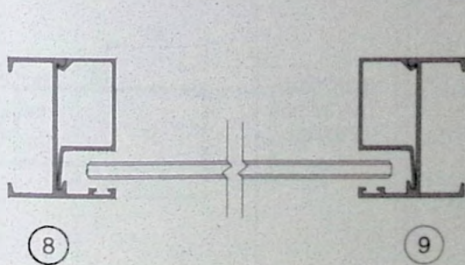
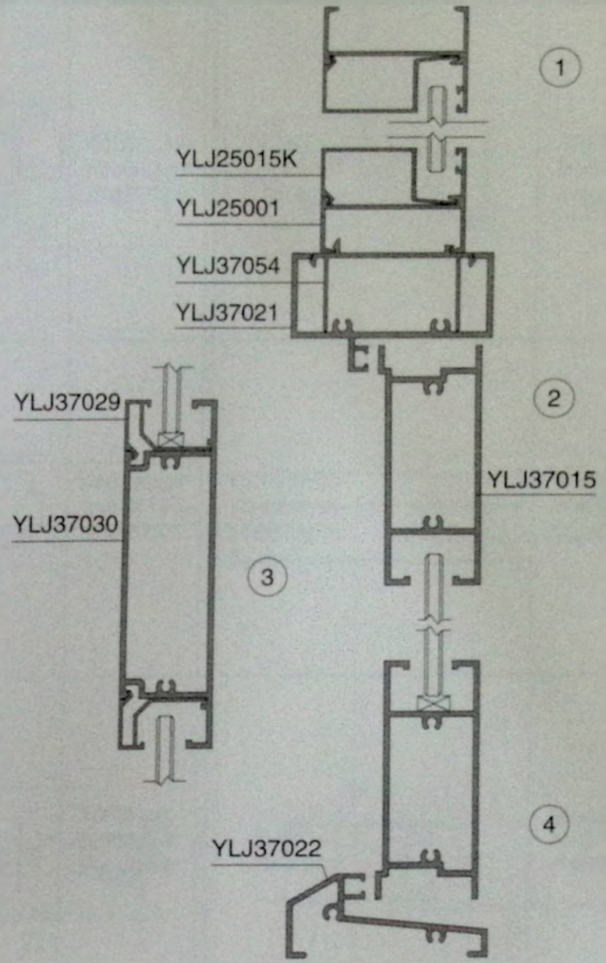
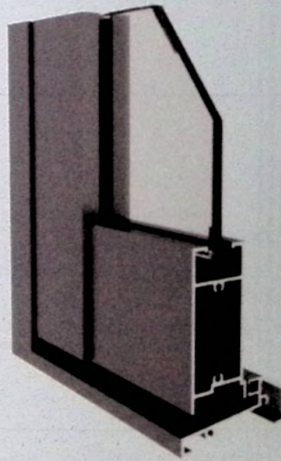
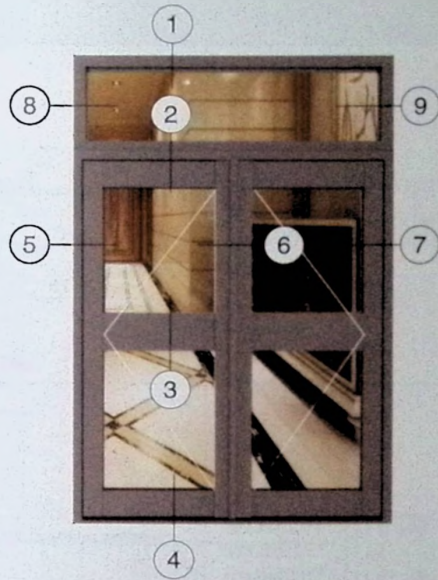



型号厚度 米重/kgm	产品图例	型号厚度 米重/kgm	产品图例	型号厚度 米重/kgm	产品图例
YLJ37001 T=1.50mm 0.832kg/m		YLJ37002 T=1.50mm 0.759kg/m		YLJ37003 T=1.50mm 0.709kg/m	
YLJ37004 T=1.50mm 1.353kg/m		YLJ37004A T=1.40mm 1.217kg/m		YLJ37005 T=1.50mm 1.198kg/m	
YLJ37006 T=1.50mm 0.720kg/m		YLJ37007 T=1.50mm 0.895kg/m		YLJ37011 T=1.60mm 1.025kg/m	
YLJ37011A T=1.80mm 1.398kg/m		YLJ37012 T=1.30mm 0.781kg/m		YLJ37012A T=1.30mm 0.781kg/m	
YLJ37012C T=1.40mm 0.833kg/m		YLJ37012E T=1.20mm 0.815kg/m		YLJ37012F T=1.40mm 0.458kg/m	

70系列平开门型材图

Aluminium Profiles for Series 70 Casement Door

永利坚铝材 YONGLIJIAN



型号厚度 米重/kgm	产品图例	型号厚度 米重/kgm	产品图例	型号厚度 米重/kgm	产品图例
YLJ37012K T=2.00mm 1.161kg/m		YLJ37013 T=1.50mm 0.879kg/m		YLJ37014 T=1.40mm 1.231kg/m	
YLJ37014B T=1.40mm 1.346kg/m		YLJ37014C T=1.20mm 1.222kg/m		YLJ37014ZK T=1.40mm 1.185kg/m	
YLJ37014BH T=2.00mm 1.786kg/m		YLJ37015 T=2.00mm 1.462kg/m		YLJ37015AZK T=2.00mm 1.385kg/m	
YLJ37015C T=1.60mm 1.202kg/m		YLJ37015ZK T=2.00mm 1.424kg/m			
YLJ37016 T=1.60mm 0.738kg/m		YLJ37016A T=1.60mm 0.735kg/m		YLJ37017 T=1.30mm 0.773kg/m	
		YLJ37016B T=1.40mm 0.688kg/m			
		YLJ37016AH T=2.00mm 0.924kg/m			
YLJ37018 T=1.00mm 0.176kg/m		YLJ37019ZK T=1.00mm 0.147kg/m		YLJ37021 T=2.00mm 0.946kg/m	
				YLJ37021A T=1.40mm 0.734kg/m	

注：图中所示为标注厚度的理论重量，实际重量以过磅时的重量为准。



型号厚度 米重/kgm	产品图例	型号厚度 米重/kgm	产品图例	型号厚度 米重/kgm	产品图例
YLJ37021B T=1.60mm 0.930kg/m		YLJ37021C T=2.00mm 1.039kg/m		YLJ37022 T=1.40mm 0.655kg/m YLJ37022H T=2.00mm 0.828kg/m	
YLJ37022A T=1.40mm 0.679kg/m		YLJ37023 T=2.00mm 0.853kg/m YLJ37023A T=1.40mm 0.640kg/m		YLJ37023B T=1.20mm 0.526kg/m	
YLJ37026 T=2.00mm 1.147kg/m YLJ37026C T=1.60mm 0.939kg/m		YLJ37026AZK T=2.00mm 1.074kg/m		YLJ37026KZK T=2.00mm 1.134kg/m	
YLJ37026ZK T=2.00mm 1.113kg/m		YLJ37026D T=1.40mm 1.094kg/m		YLJ37026E T=1.20mm 0.717kg/m	
YLJ37027 T=2.00mm 1.261kg/m YLJ37027C T=1.60mm 1.031kg/m		YLJ37027D T=1.40mm 0.293kg/m		YLJ37027AZK T=2.00mm 1.184kg/m	

70系列平开门型材图

Aluminium Profiles for Series 70 Casement Door

永利坚铝材 YONGLIJIAN



型号 厚度 米重/kgm	产品图例	型号 厚度 米重/kgm	产品图例	型号 厚度 米重/kgm	产品图例
YLJ37027KZK T=2.00mm 1.272kg/m		YLJ37027ZK T=2.00mm 1.223kg/m		YLJ37029 T=1.20mm 0.232kg/m	
YLJ37029ZK T=1.20mm 0.210kg/m		YLJ37030 T=2.00mm 1.739kg/m		YLJ37030ZK T=2.00mm 1.707kg/m	
YLJ37031 T=1.20mm 0.924kg/m		YLJ37033 T=1.20mm 1.079kg/m		YLJ37035 T=1.40mm 1.036kg/m	
YLJ37035ZK T=1.40mm 0.982kg/m		YLJ37036 T=1.30mm 0.997kg/m		YLJ37035A T=2.00mm 1.340kg/m	
YLJ37037 T=1.40mm 1.136kg/m		YLJ37036ZK T=1.40mm 1.007kg/m		YLJ37035H T=1.60mm 1.149kg/m	
YLJ37037AZK T=1.90mm 1.436kg/m		YLJ37037ZK T=1.40mm 1.102kg/m		YLJ37039 T=1.00mm 0.190kg/m	

注：图中所示为标注厚度的理论重量，实际重量以过磅时的重量为准。



型号厚度 米重/kgm	产品图例	型号厚度 米重/kgm	产品图例	型号厚度 米重/kgm	产品图例
YLJ37039ZK T=1.00mm 0.191kg/m		YLJ37042 T=2.00mm 1.238kg/m		YLJ37044 T=2.00mm 2.251kg/m	
YLJ37054 T=1.20mm 0.443kg/m		YLJ37055 T=1.20mm 0.606kg/m		YLJ37056 T=1.20mm 0.829kg/m	
YLJ37057 T=1.20mm 1.051kg/m		YLJ37058 T=1.20mm 0.609kg/m		YLJ37063 T=1.40mm 1.062kg/m	
YLJ37064 T=1.20mm 0.756kg/m		YLJ37068 T=1.40mm 0.827kg/m		YLJ37069 T=1.40mm 0.353kg/m	
YLJ37070 T=2.00mm 1.388kg/m		YLJ37071 T=2.00mm 1.084kg/m		YLJ37072 T=2.00mm 1.216kg/m	

70系列平开门型材图

Aluminium Profiles for Series 70 Casement Door

永利坚铝材 YONGLIJIAN



型号厚度 米重/kgm	产品图例	型号厚度 米重/kgm	产品图例	型号厚度 米重/kgm	产品图例
YLJ37073 T=1.60mm 0.753kg/m		YLJ37074 T=1.60mm 1.136kg/m		YLJ37075 T=1.60mm 0.971kg/m	
YLJ37076 T=1.60mm 0.956kg/m		YLJ37077 T=1.60mm 1.147kg/m		YLJ37078 T=1.60mm 1.334kg/m	

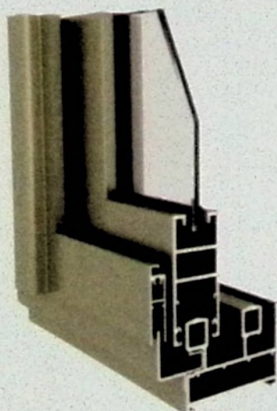
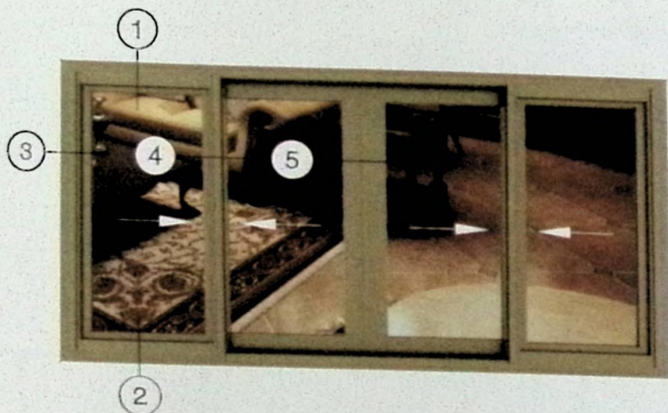

YLJ37201
角码配:GRD7210

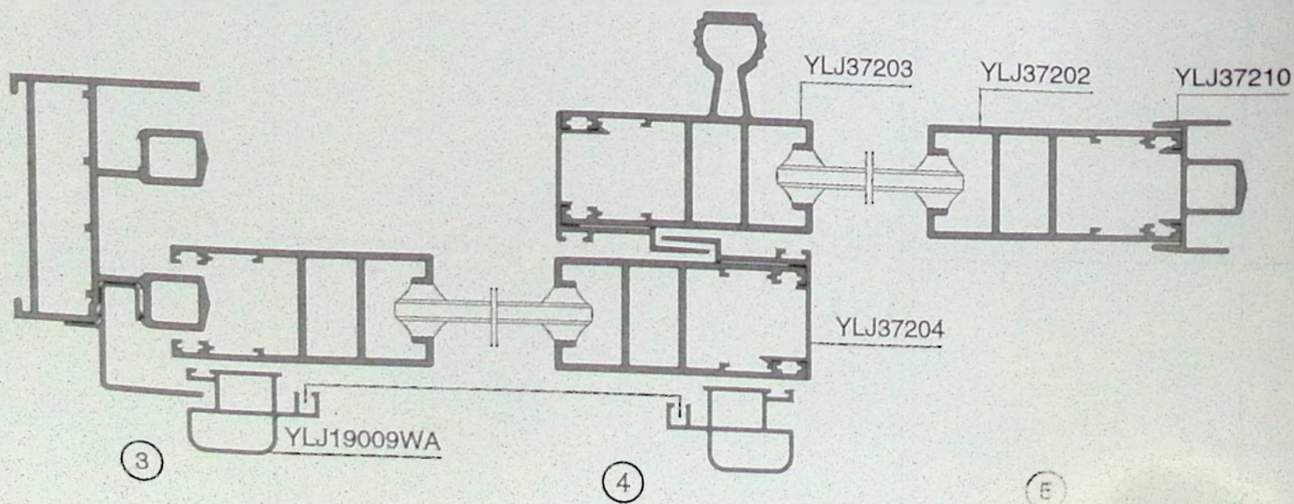
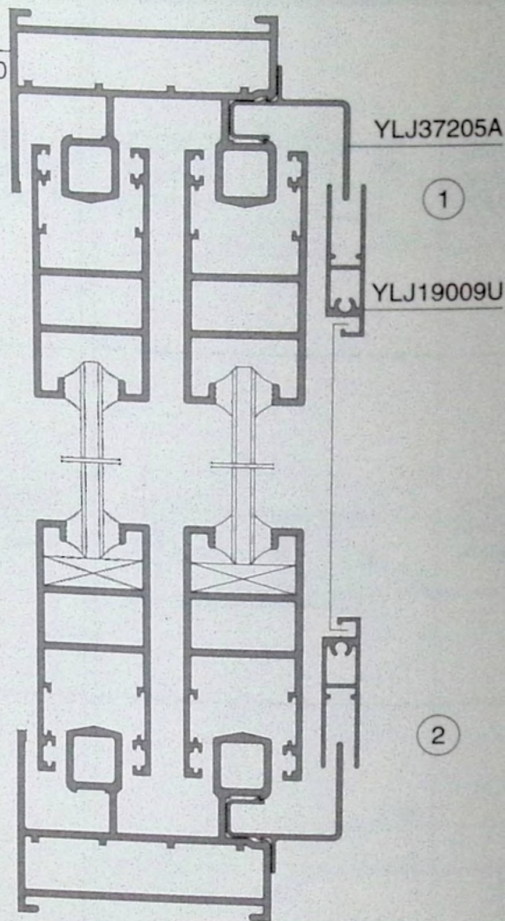

72系列推拉门结构图

Structure Diagram of Series 72 Sliding Door

永利坚铝材 YONGLIJIAN

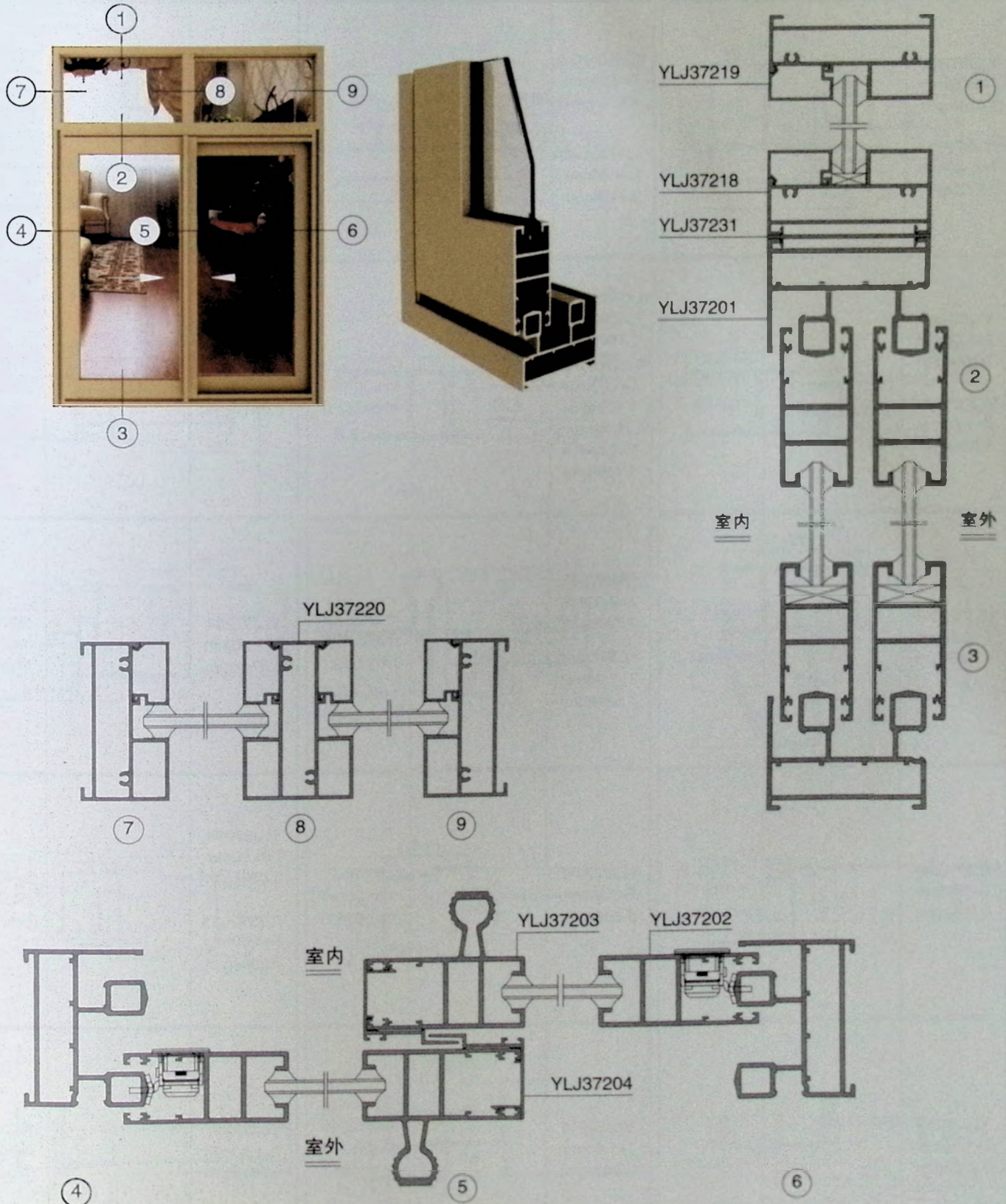



型号厚度 米重/kgm	产品图例	型号厚度 米重/kgm	产品图例	型号厚度 米重/kgm	产品图例
YLJ37201 T=2.00mm 2.034kg/m YLJ37201A T=1.40mm 1.573kg/m		YLJ37201-3 T=2.00mm 2.974kg/m YLJ37201-3A T=1.60mm 2.442kg/m		YLJ37201JA T=2.00mm 2.210kg/m	
YLJ37202 T=2.00mm 1.260kg/m YLJ37202A T=1.60mm 1.095kg/m		YLJ37202CHZK T=2.00mm 1.168kg/m YLJ37202CAZK T=1.90mm 1.130kg/m YLJ37202CPZK T=1.95mm 1.149kg/m		YLJ37202DZK T=1.40mm 0.931kg/m	
YLJ37202F T=2.00mm 2.720kg/m		YLJ37203 T=2.00mm 1.753kg/m YLJ37203A T=1.60mm 1.546kg/m		YLJ37204 T=1.30mm 0.374kg/m	
YLJ37204A T=1.30mm 0.359kg/m		YLJ37204D T=1.30mm 0.556kg/m		YLJ37205 T=1.00mm 0.258kg/m YLJ37205A T=1.00mm 0.298kg/m	
YLJ37209 T=1.20mm 0.216kg/m		YLJ37210 T=1.40mm 0.560kg/m		YLJ37211 T=1.50mm 0.261kg/m	

72系列推拉门型材图

Aluminium Profiles for Series 72 Sliding Door

永利坚铝材 YONGLIJIAN



型号厚度 米重/kgm	产品图例	型号厚度 米重/kgm	产品图例	型号厚度 米重/kgm	产品图例
YLJ37212 T=1.20mm 0.170kg/m		YLJ37213A T=1.30mm 0.552kg/m		YLJ37218 T=1.40mm 1.076kg/m	
YLJ37219 T=1.00mm 0.182kg/m		YLJ37219A T=1.00mm 0.159kg/m		YLJ37219B T=1.00mm 0.153kg/m	
YLJ37222 T=1.60mm 2.563kg/m		YLJ37220 T=1.40mm 1.266kg/m		YLJ37225 T=1.40mm 0.740kg/m	
YLJ37204D T=1.30mm 0.556kg/m		YLJ37231 T=1.60mm 0.353kg/m		YLJ37233 T=1.60mm 0.540kg/m	
YLJ37234 T=1.60mm 1.803kg/m		YLJ37235 T=1.60mm 1.668kg/m		YLJ37236 T=1.50mm 0.268kg/m	

注：图中所示为设计厚度的理论重量，实际重量以过磅时的重量为准

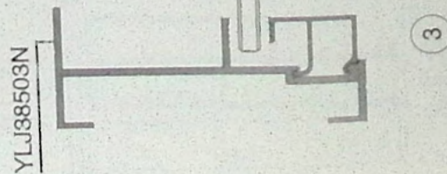
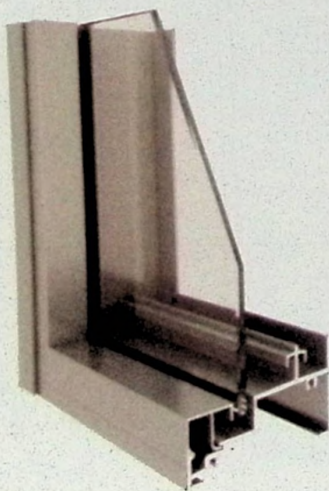
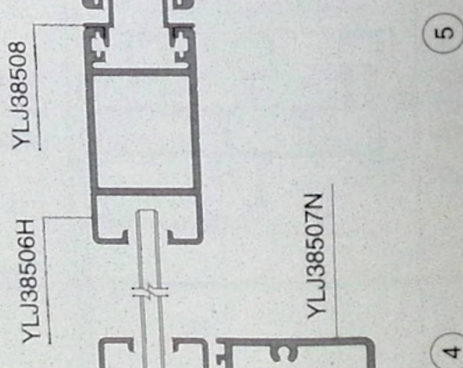
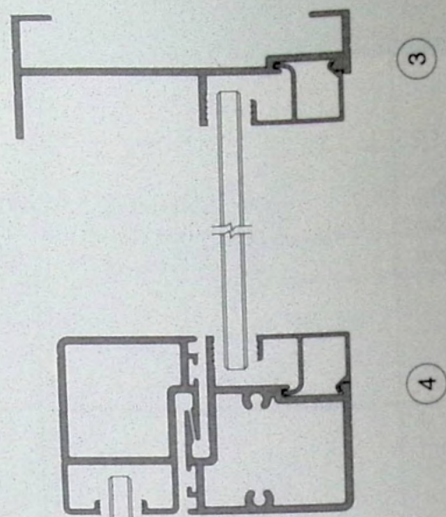
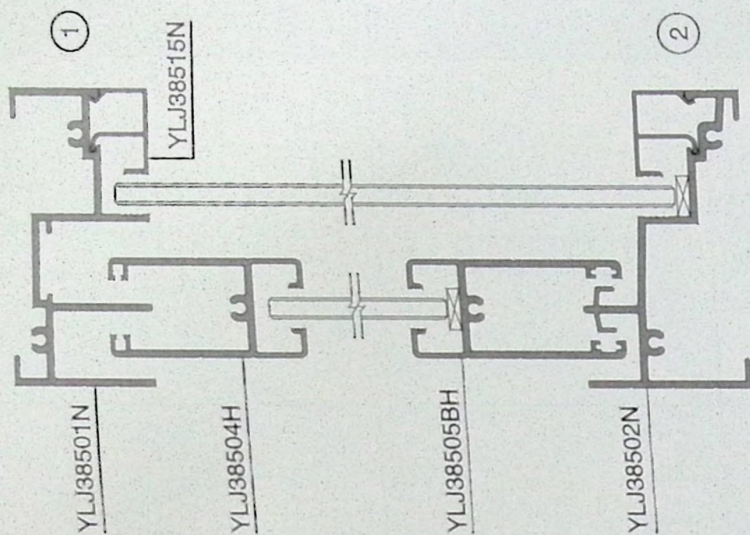

85系列推拉门(中空)结构图

Structure Diagram of Series 85 Sliding Door(Hollow)

永利坚铝材 YONGLIJIAN

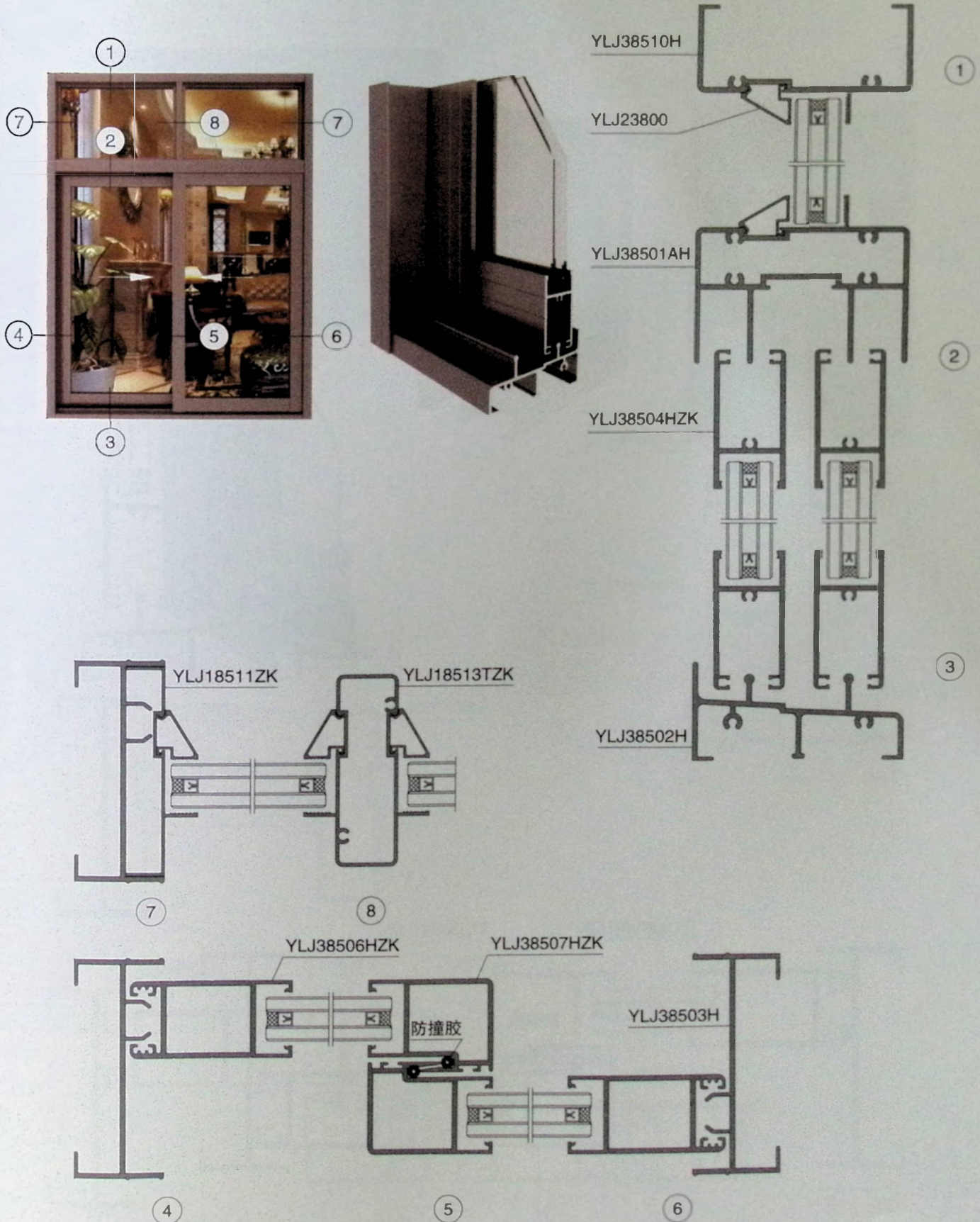

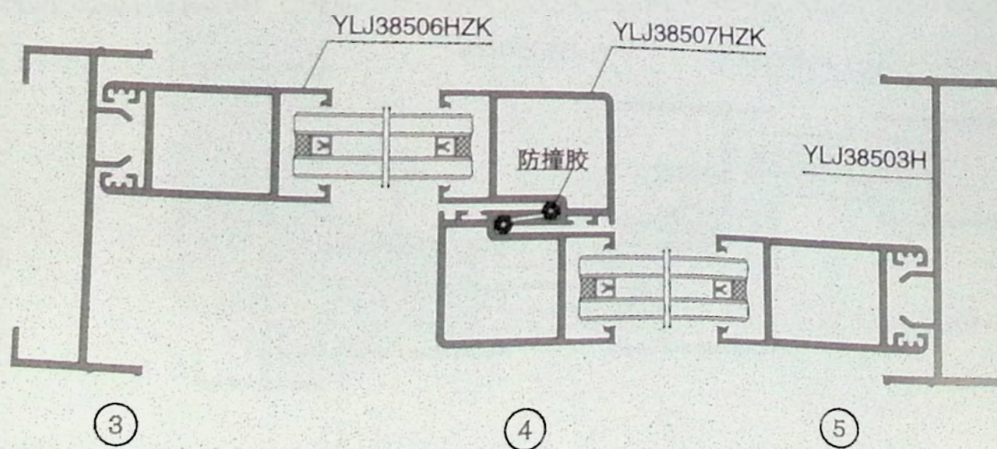
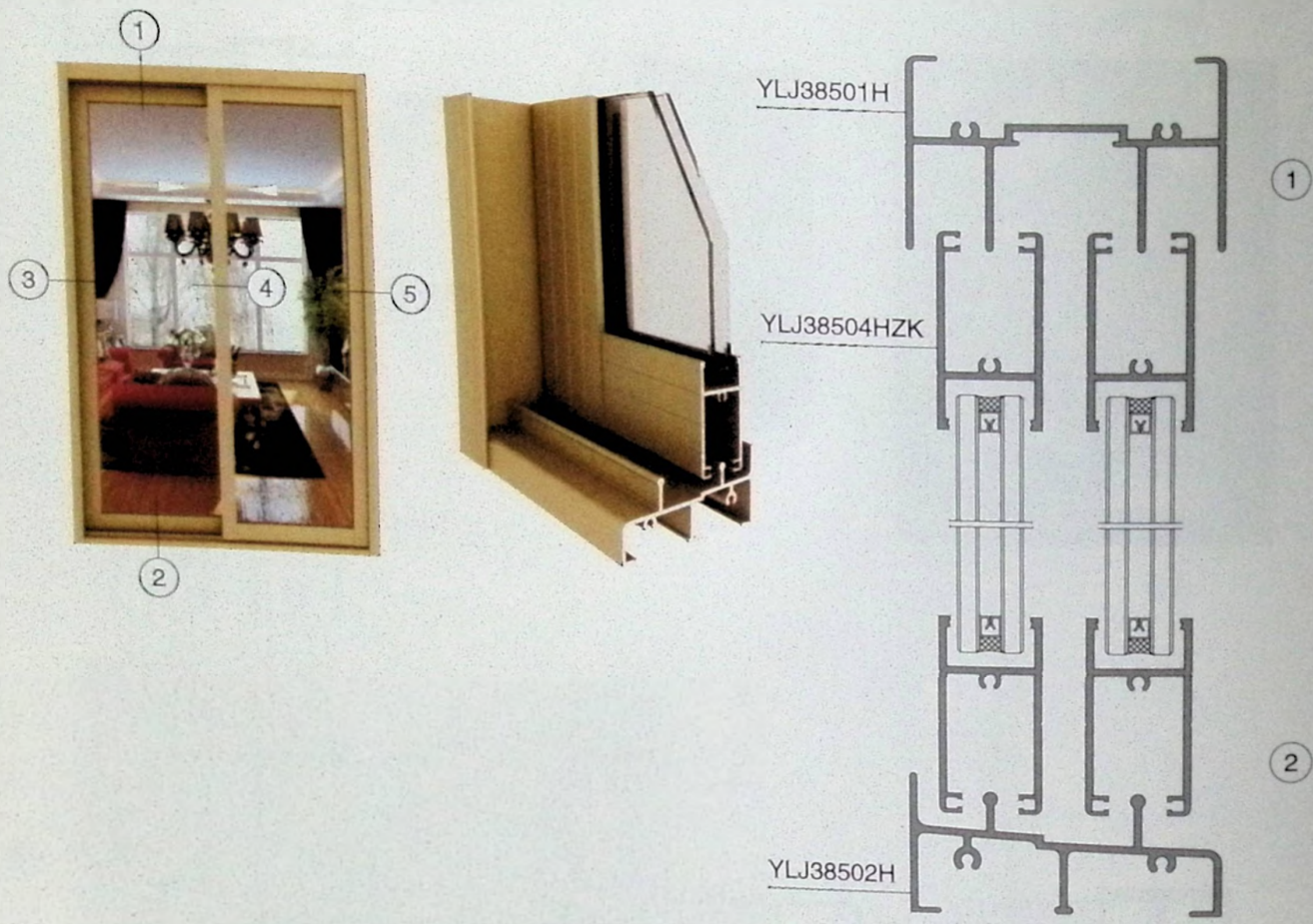

85系列推拉门结构图

Structure Diagram of Series 85 Sliding Door

永利坚铝材 YONGLIJIAN

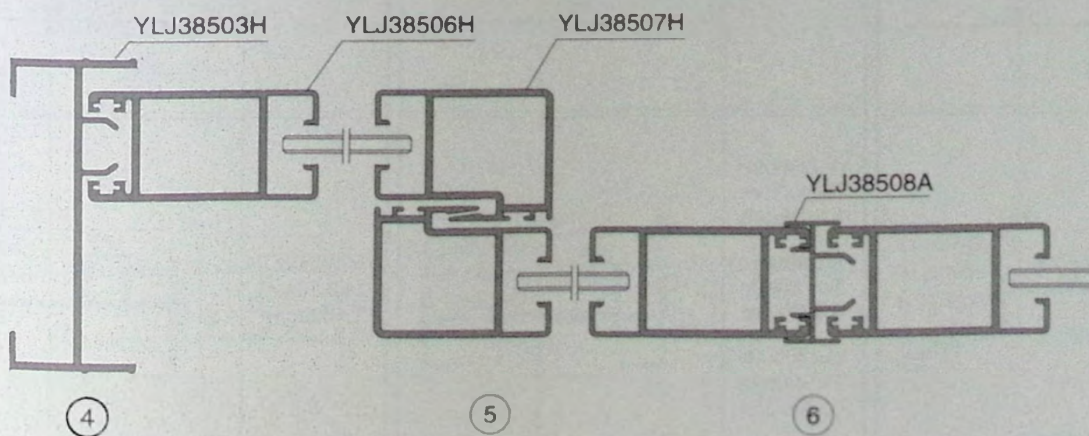
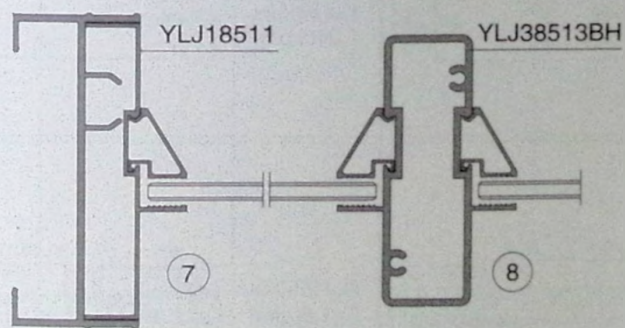
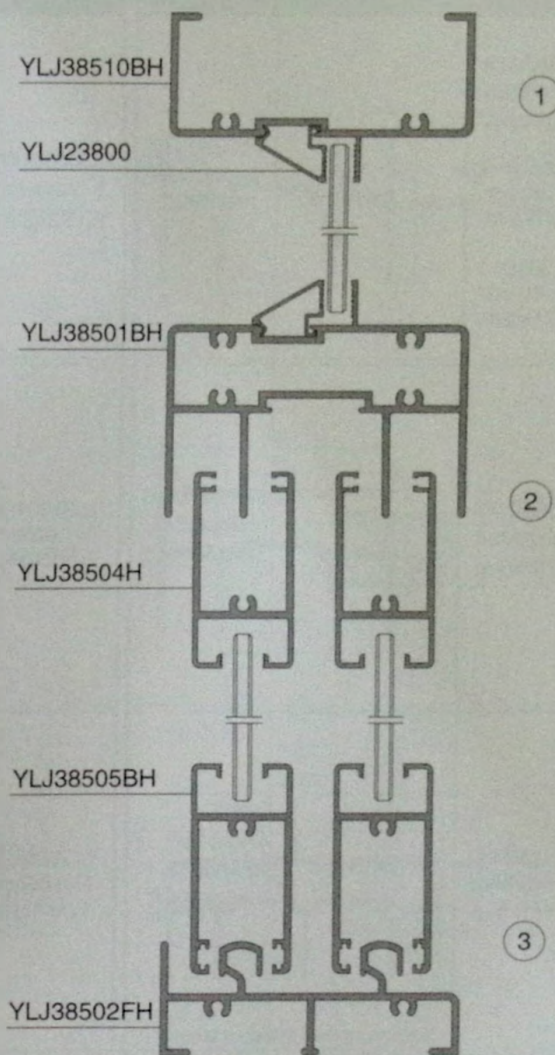
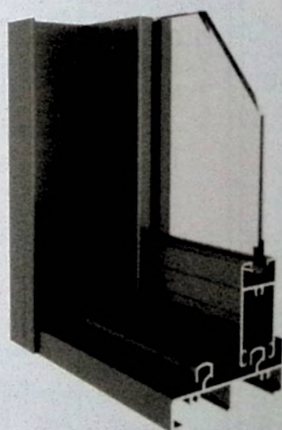
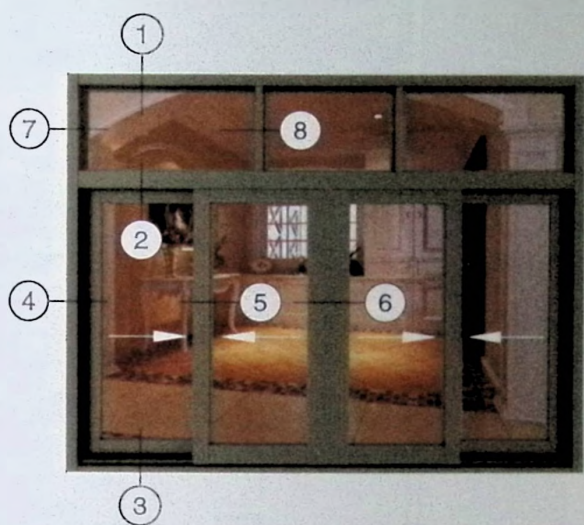



型号厚度 米重/kgm	产品图例	型号厚度 米重/kgm	产品图例	型号厚度 米重/kgm	产品图例
YLJ38501H T=2.00mm 1.566kg/m		YLJ38501BH T=2.00mm 2.162kg/m	 压线配YLJ23800 (玻璃位: 7.8mm)	YLJ38501AH T=2.00mm 2.141kg/m	 压线配YLJ23800 (玻璃位: 22mm)
YLJ38501HD T=1.80mm 1.437kg/m		YLJ38501LH T=1.80mm 1.712kg/m		YLJ38501AB T=1.80mm 1.965kg/m	
YLJ38501J T=1.60mm 1.271kg/m		YLJ38501GH T=2.00mm 1.918kg/m		YLJ38501N T=2.00mm 1.386kg/m	
		YLJ38502H T=2.00mm 1.267kg/m		YLJ38502FH T=2.00mm 1.341kg/m	
YLJ38521 T=1.80mm 2.541kg/m	 压线配YLJ23800 (玻璃位: 7.8mm)	YLJ38502LH T=1.80mm 1.693kg/m		YLJ38502HD T=1.80mm 1.240kg/m	
YLJ38502GH T=2.00mm 1.148kg/m		YLJ38503H T=2.00mm 1.003kg/m		YLJ38502K T=1.90mm 0.823kg/m	 YLJ82025B
YLJ38502GB T=1.80mm 1.063kg/m		YLJ38503HD T=1.80mm 0.923kg/m		YLJ38503CH T=2.00mm 1.102kg/m	
YLJ38502N T=2.00mm 1.183kg/m		YLJ38503J T=1.60mm 0.834kg/m			

85系列推拉门型材图

Aluminium Profiles for Series 85 Sliding Door

永利坚铝材 YONGLIJIAN



型号厚度 米重/kgm	产品图例	型号厚度 米重/kgm	产品图例	型号厚度 米重/kgm	产品图例
YLJ38503AH T=2.00mm 1.610kg/m		YLJ38503LH T=1.80mm 1.134kg/m		YLJ38503N T=2.00mm 0.941kg/m	
YLJ38523 T=1.80mm 1.135kg/m		YLJ38504H T=2.00mm 0.860kg/m		YLJ38504AH T=1.95mm 0.846kg/m	
YLJ38504AHZK T=1.80mm 0.782kg/m		YLJ38504HZK T=2.00mm 0.859kg/m		YLJ38504BH T=2.00mm 0.848kg/m	
YLJ38504B T=1.60mm 0.768kg/m		YLJ38504DZK T=2.00mm 0.839kg/m		YLJ38504FZK T=1.80mm 0.790kg/m	
YLJ38504K T=2.00mm 1.275kg/m		YLJ38505BH T=2.00mm 0.913kg/m		YLJ38505BHZK T=2.00mm 0.913kg/m	



型号厚度 米重/kgm	产品图例	型号厚度 米重/kgm	产品图例	型号厚度 米重/kgm	产品图例
YLJ38505C T=2.00mm 0.874kg/m		YLJ38505DZK T=2.00mm 0.892kg/m		YLJ38505J T=1.60mm 0.834kg/m	
YLJ38505K T=2.00mm 1.281kg/m		YLJ38524 T=1.60mm 0.787kg/m		YLJ38506H T=2.00mm 1.108kg/m	
YLJ38506HZK T=2.00mm 1.062kg/m		YLJ38506B T=1.60mm 0.951kg/m		YLJ38506C T=2.00mm 1.263kg/m	
YLJ38506D T=1.80mm 1.040kg/m		YLJ38506DZK T=2.00mm 1.053kg/m		YLJ38506FZK T=1.80mm 0.988kg/m	
YLJ38506KA T=2.00mm 1.591kg/m		YLJ38507H T=2.00mm 1.014kg/m		YLJ38507HZK T=2.00mm 0.972kg/m	

85系列推拉门型材图

Aluminium Profiles for Series 85 Sliding Door

永利坚铝材 YONGLIJIAN



型号厚度 米重/kgm	产品图例	型号厚度 米重/kgm	产品图例	型号厚度 米重/kgm	产品图例
YLJ38507B T=1.60mm 0.854kg/m YLJ38507L T=1.80mm 0.924kg/m		YLJ38507D T=1.40mm 0.808kg/m		YLJ38507DZK T=2.00mm 0.963kg/m	
YLJ38507FZK T=1.80mm 0.896kg/m		YLJ38507HZKJ T=2.00mm 1.981kg/m		YLJ38507K T=2.00mm 1.590kg/m	
YLJ38507N T=2.00mm 1.107kg/m	 配压线: YLJ38515N、YLJ38515NA	YLJ38508 T=1.00mm 0.187kg/m		YLJ38508A T=1.00mm 0.301kg/m	
YLJ38508PT T=1.00mm 0.296kg/m	 喷涂专用	YLJ38528 T=1.20mm 0.263kg/m		YLJ38510BH T=2.00mm 1.085kg/m	
YLJ38510H T=2.00mm 1.043kg/m YLJ38510HB T=1.80mm 0.967kg/m		YLJ38510G T=2.00mm 1.069kg/m		YLJ38525 T=1.80mm 1.144kg/m	

注: 图中所列为标注厚度的理论重量, 实际重量以过磅时的重量为准。



型号厚度 米重/kgm	产品图例	型号厚度 米重/kgm	产品图例	型号厚度 米重/kgm	产品图例
YLJ18511 T=1.20mm 0.453kg/m YLJ185系列		YLJ18511ZK T=1.20mm 0.458kg/m YLJ185系列		YLJ18511A T=1.20mm 0.402kg/m YLJ185系列	
YLJ38526 T=1.40mm 0.676kg/m		YLJ38513BH T=2.00mm 1.362kg/m		YLJ38515N T=1.00mm 0.189kg/m	
YLJ38515NA T=1.00mm 0.143kg/m		YLJ38518AH T=2.00mm 2.035kg/m		YLJ38530 T=1.50mm 1.827kg/m	

85系列推拉门结构图

Structure Diagram of Series 85 Sliding Door

永利坚铝材 YONGLIJIAN

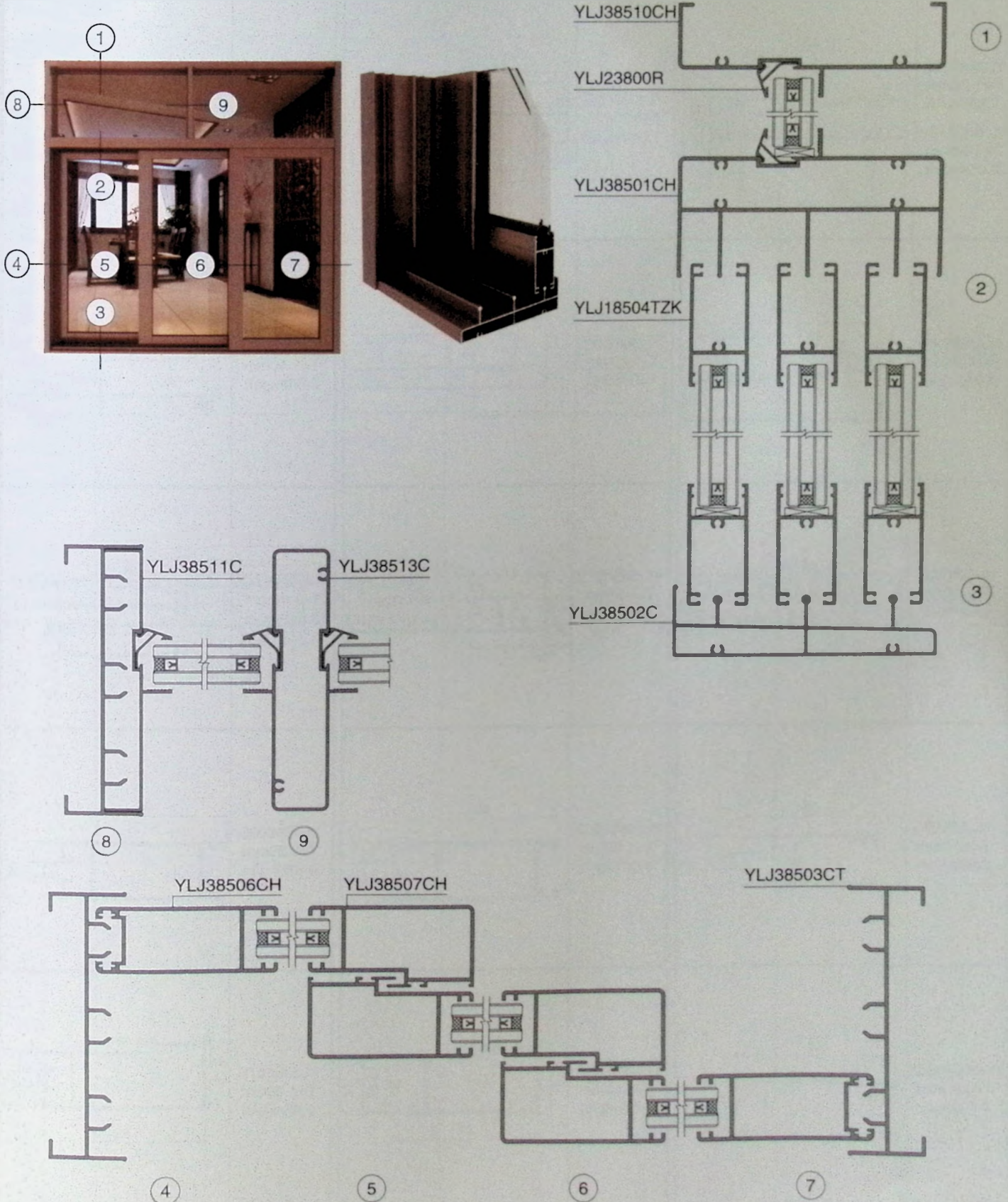



型号厚度 米重/kgm	产品图例	型号厚度 米重/kgm	产品图例	型号厚度 米重/kgm	产品图例
YLJ38501C T=1.20mm 1.637kg/m YLJ38501CH T=1.55mm 2.054kg/m		YLJ38501D T=1.20mm 1.044kg/m		YLJ38502B T=1.20mm 0.985kg/m	
YLJ38502BA T=1.20mm 1.433kg/m		YLJ38502C T=1.20mm 1.217kg/m		YLJ38502S T=1.40mm 0.868kg/m	
YLJ38503C T=1.20mm 0.881kg/m		YLJ38503CT T=1.55mm 1.127kg/m		YLJ18504TZK T=1.40mm 0.613kg/m YLJ185系列	
YLJ38505S T=1.20mm 0.800kg/m		YLJ38506CH T=1.55mm 1.027kg/m		YLJ38506S T=1.20mm 0.850kg/m	
YLJ38506SZK T=1.20mm 0.797kg/m		YLJ38507CH T=1.55mm 1.004kg/m		YLJ38507S T=1.20mm 0.924kg/m	

85系列推拉门型材图

Aluminium Profiles for Series 85 Sliding Door

永利坚铝材 YONGLIJIAN



型号厚度 米重/kgm	产品图例	型号厚度 米重/kgm	产品图例	型号厚度 米重/kgm	产品图例
YLJ38507SZK T=1.20mm 0.871kg/m		YLJ38508S T=1.00mm 0.165kg/m		YLJ38509C T=0.80mm 0.107kg/m	
YLJ38510C T=1.20mm 0.759kg/m		YLJ38510D T=1.20mm 1.178kg/m		YLJ38511C T=1.20mm 0.570kg/m	
YLJ38510CH T=1.55mm 0.947kg/m		YLJ38513C T=1.20mm 1.145kg/m		YLJ38519 T=1.20mm 0.761kg/m	

注: 图中所示为标注厚度的理论重量, 实际重量以过磅时的重量为准。

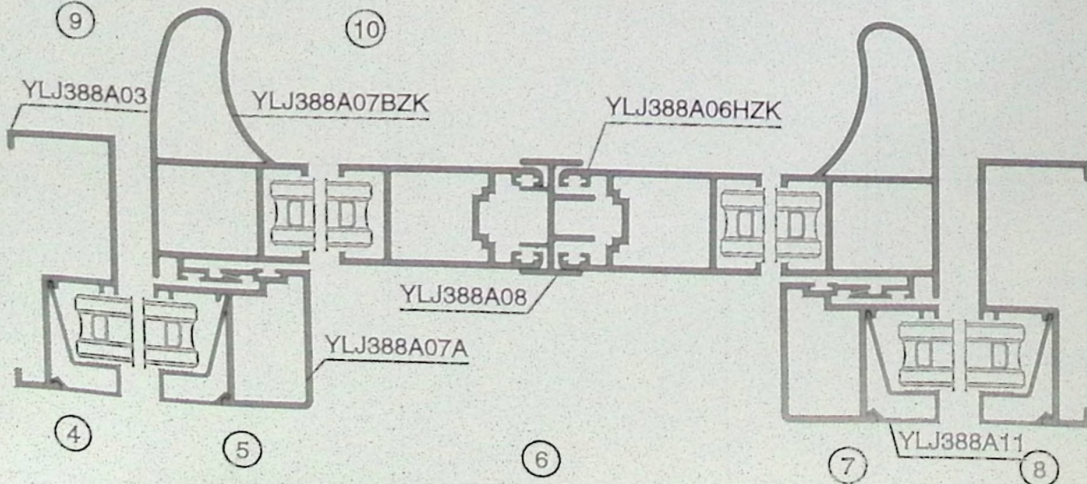
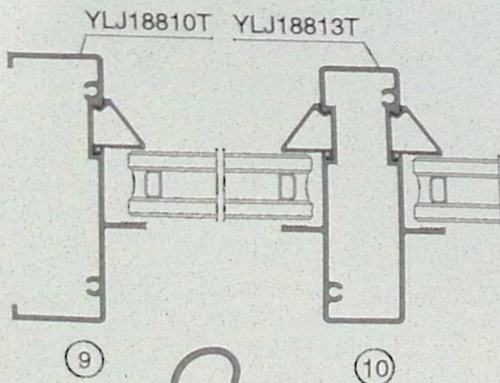
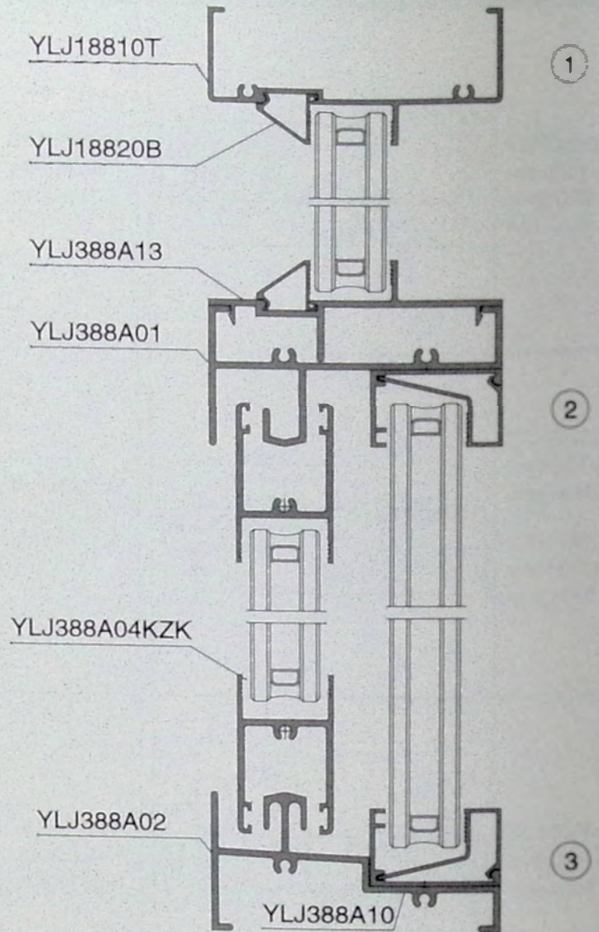
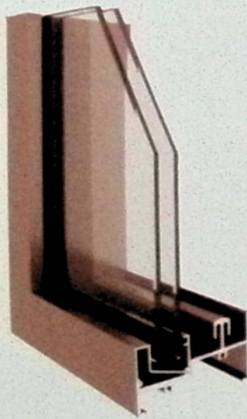
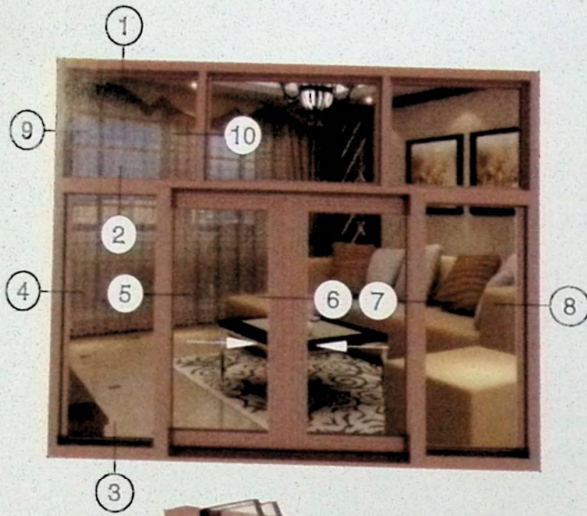

88A推拉门结构图

Structure Diagram of Series 88A Sliding Door

永利坚铝材 YONGLIJIAN

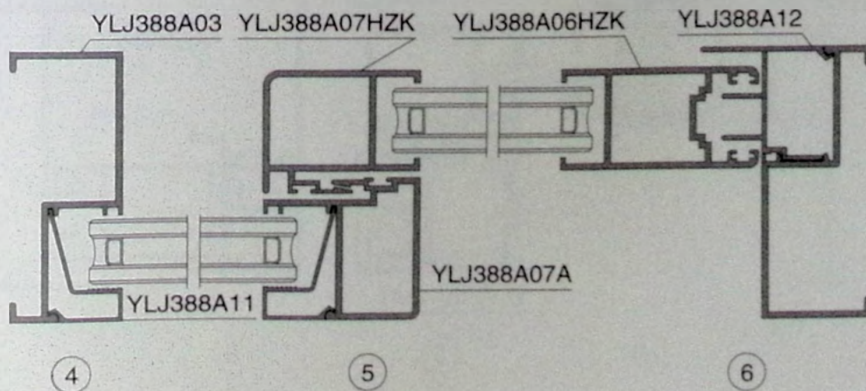
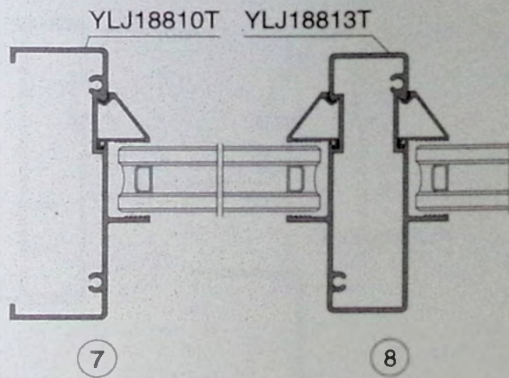
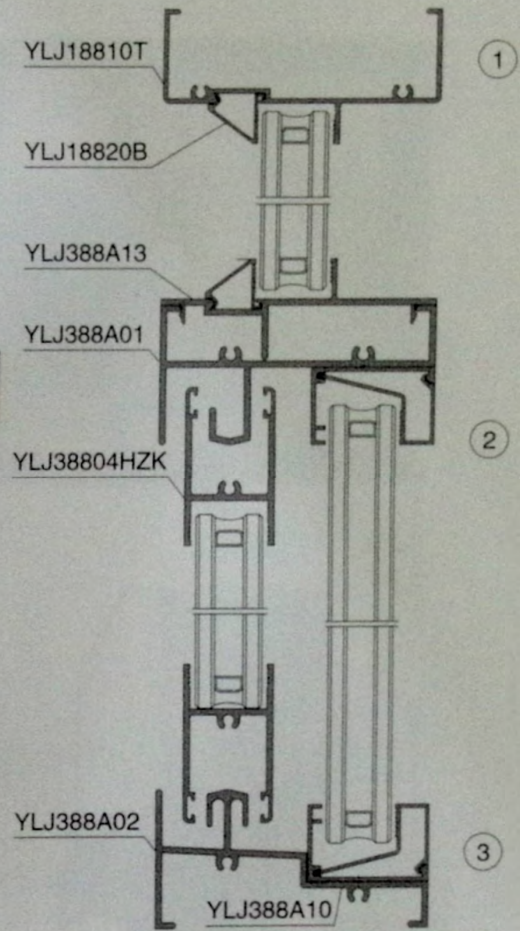
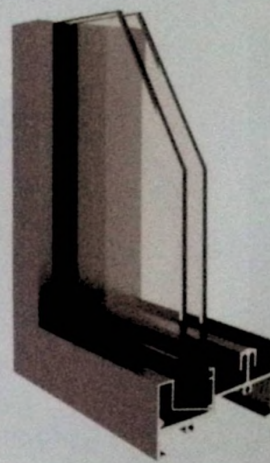
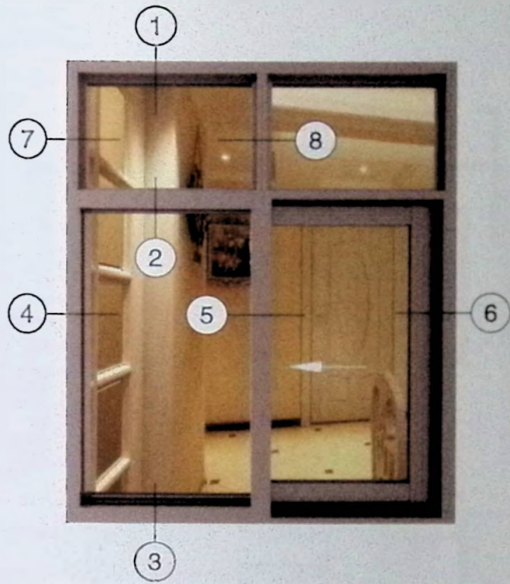

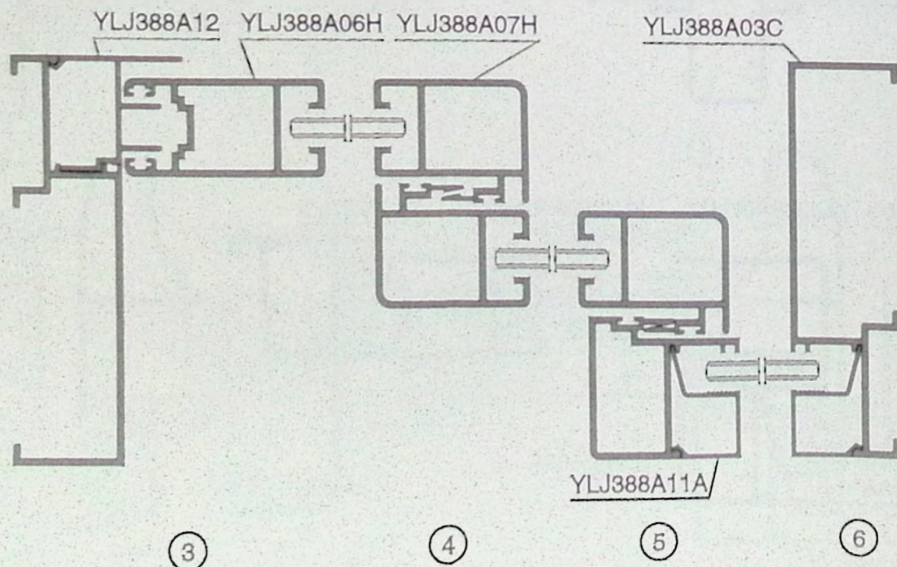
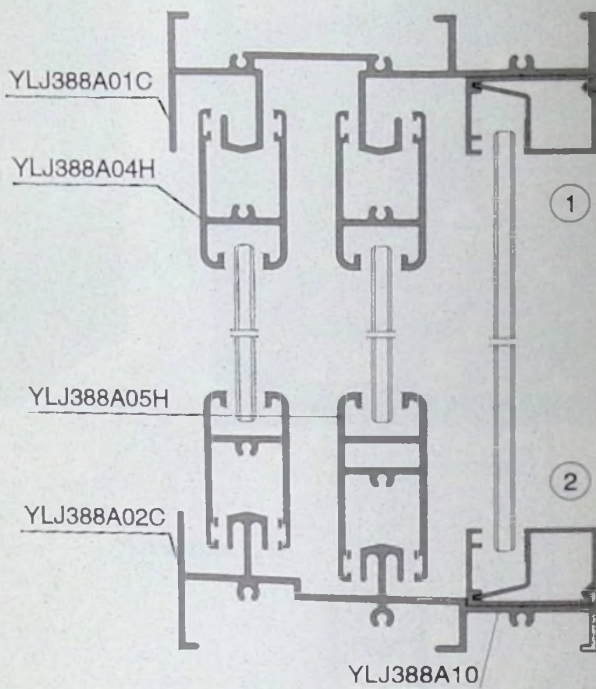
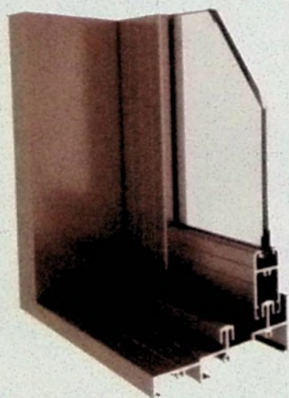

88A推拉门结构图

Structure Diagram of Series 88A Sliding Door

永利坚铝材 YONGLIJIAN

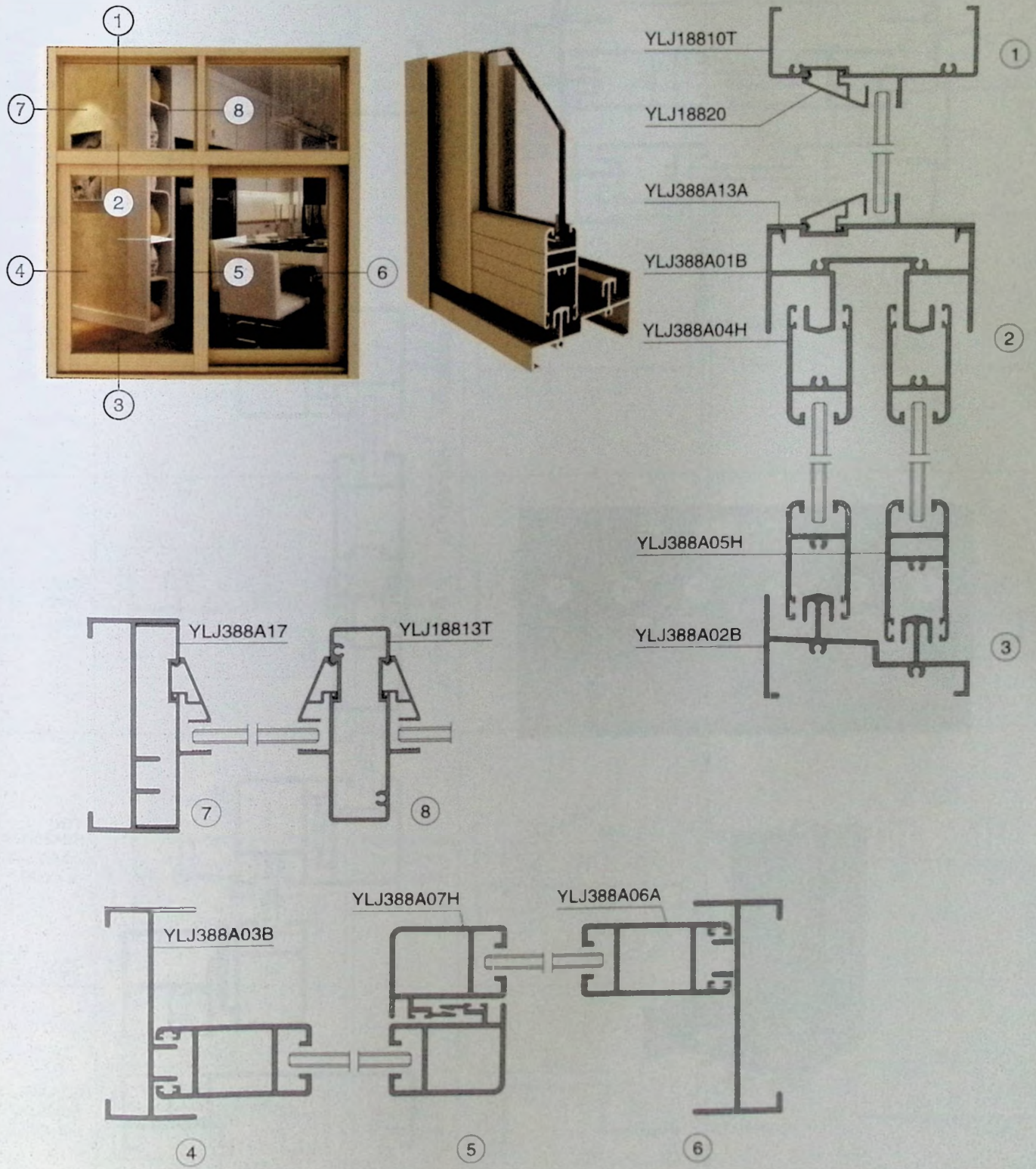

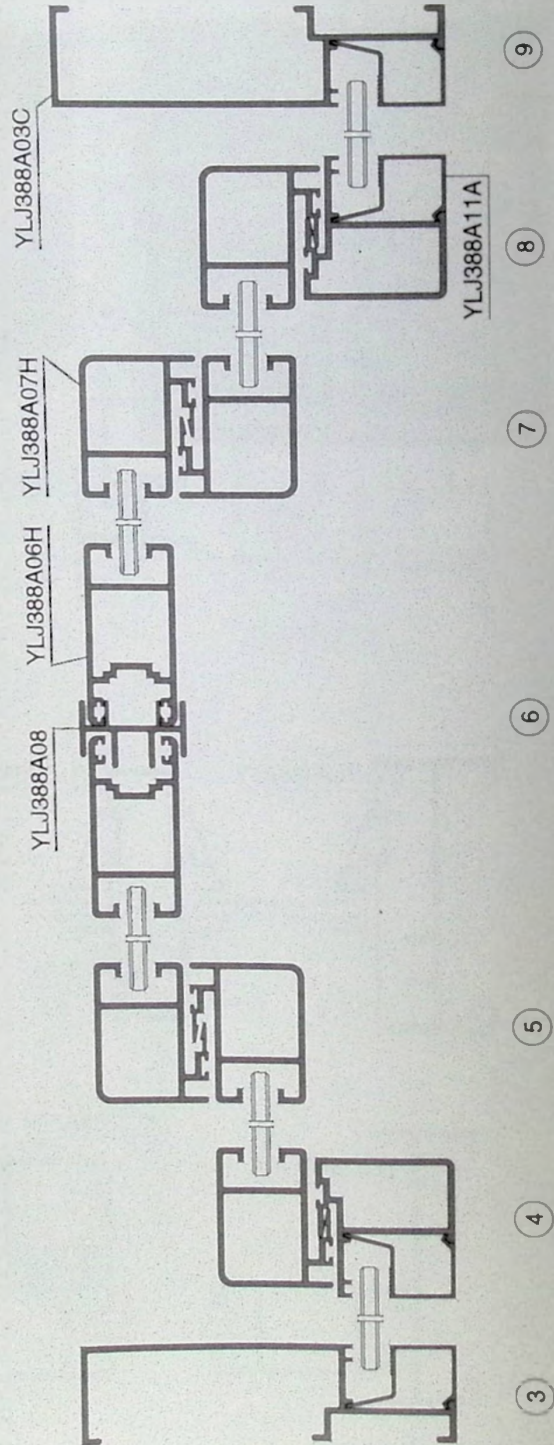
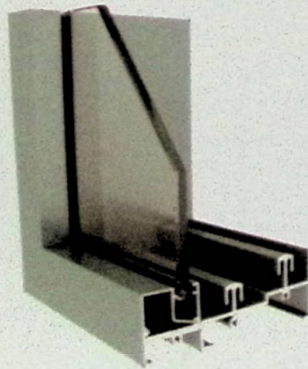
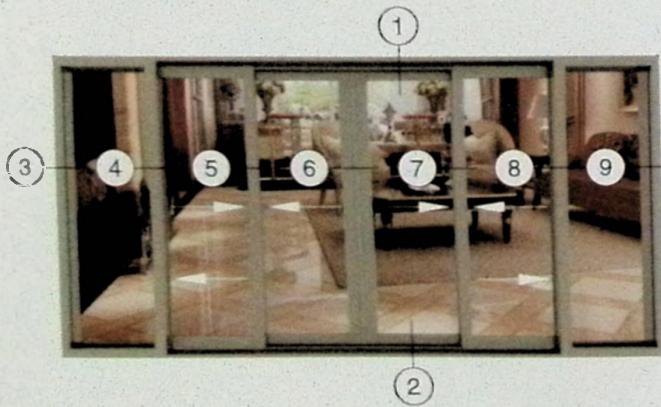
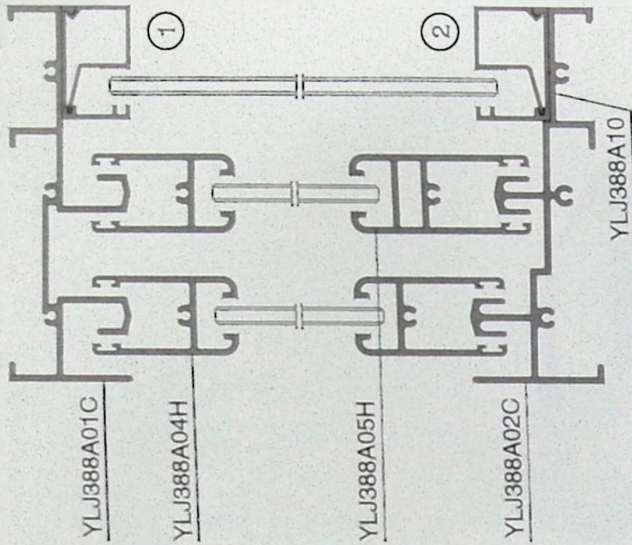

88A推拉门型材图

Aluminium Profiles for Series 88A Sliding Door

永利坚铝材 YONGLIJIAN



型号厚度 米重/kgm	产品图例	型号厚度 米重/kgm	产品图例	型号厚度 米重/kgm	产品图例
YLJ388A01 T=2.00mm 1.200kg/m		YLJ388A01B T=2.00mm 1.633kg/m		YLJ388A01C T=2.00mm 1.896kg/m	
YLJ388A01G T=2.00mm 2.097kg/m		YLJ388A01M T=2.00mm 1.378kg/m		YLJ388A02 T=2.00mm 1.248kg/m	
YLJ388A02B T=2.00mm 1.511kg/m		YLJ388A02C T=2.00mm 1.918kg/m		YLJ388A02D T=2.00mm 1.398kg/m	
YLJ388A02F T=2.00mm 1.565kg/m		YLJ388A02G T=2.00mm 2.026kg/m		YLJ388A02H T=2.00mm 1.572kg/m	
YLJ388A02M T=2.00mm 2.282kg/m		YLJ388A03 T=2.00mm 0.941kg/m		YLJ388A03B T=2.00mm 1.074kg/m	

注：图中所示为标注厚度的理论重量，实际重量以过磅时的重量为准。



型号厚度 米重/kgm	产品图例	型号厚度 米重/kgm	产品图例	型号厚度 米重/kgm	产品图例
YLJ388A03BP T=1.90mm 1.021kg/m		YLJ388A03G T=2.00mm 1.285kg/m		YLJ388A03G T=2.00mm 1.306kg/m	
YLJ388A03M T=2.00mm 2.169kg/m		YLJ388A04AZK T=2.00mm 0.740kg/m		YLJ388A04E T=2.00mm 0.826kg/m	
YLJ388A04FZK T=2.00mm 0.765kg/m		YLJ388A04H T=2.00mm 0.800kg/m		YLJ388A04HP T=1.90mm 0.768kg/m	
YLJ388A04HZK T=2.00mm 0.733kg/m		YLJ388A04KZK T=2.00mm 0.708kg/m		YLJ388A05A T=1.60mm 0.751kg/m	
YLJ388A05AZK T=1.60mm 0.769kg/m		YLJ388A05E T=2.00mm 1.060kg/m		YLJ388A05FZK T=2.00mm 1.004kg/m	

注：图中所示为标注厚度的理论重量，实际重量以过磅时的重量为准。



型号厚度 米重/kgm	产品图例	型号厚度 米重/kgm	产品图例	型号厚度 米重/kgm	产品图例
YLJ388A05H T=2.00mm 1.027kg/m		YLJ388A05HZK T=2.00mm 0.971kg/m		YLJ388A05KZK T=2.00mm 0.955kg/m	
YLJ388A06A T=2.00mm 1.183kg/m		YLJ388A06E T=2.00mm 1.297kg/m		YLJ388A06H T=2.00mm 1.234kg/m	
YLJ388A06HP T=1.90mm 1.206kg/m		YLJ388A06HZK T=2.00mm 1.164kg/m		YLJ388A06KZK T=2.00mm 1.128kg/m	
YLJ388A07A T=2.00mm 1.005kg/m		YLJ388A07BZK T=2.00mm 1.670kg/m		YLJ388A07E T=2.00mm 1.823kg/m	
YLJ388A07HA T=2.00mm 1.748kg/m		YLJ388A07HP T=1.90mm 1.081kg/m		YLJ388A07H T=2.00mm 1.114kg/m	

注：图中所示为标注厚度的理论重量，实际重量以过磅时的重量为准。



型号厚度 米重/kgm	产品图例	型号厚度 米重/kgm	产品图例	型号厚度 米重/kgm	产品图例
YLJ388A07HZK T=2.00mm 1.033kg/m		YLJ388A07KZK T=2.00mm 0.995kg/m		YLJ388A08 T=1.90mm 0.572kg/m	
YLJ388A08A T=1.90mm 0.492kg/m		YLJ388A08B T=1.40mm 0.425kg/m		YLJ388A10 T=1.40mm 0.306kg/m	
YLJ388A10A T=1.40mm 0.477kg/m		YLJ388A11 T=1.10mm 0.238kg/m		YLJ388A11A T=1.10mm 0.246kg/m	
YLJ388A11B T=1.10mm 0.227kg/m		YLJ388A11P T=0.90mm 0.200kg/m		YLJ388A11AP T=0.90mm 0.206kg/m	
YLJ388A11C T=1.10mm 0.239kg/m		YLJ388A11H T=0.90mm 0.194kg/m		YLJ388A11H T=0.90mm 0.194kg/m	
YLJ388A12 T=1.40mm 0.510kg/m		YLJ388A13 T=2.00mm 0.708kg/m		YLJ388A13A T=2.00mm 0.631kg/m	

88A推拉门型材图

Aluminium Profiles for Series 88A Sliding Door

永利坚铝材 YONGLIJIAN



型号厚度 米重/kgm	产品图例	型号厚度 米重/kgm	产品图例	型号厚度 米重/kgm	产品图例
YLJ388A17 T=1.20mm 0.489kg/m		YLJ388A18 T=1.80mm 0.257kg/m		YLJ388A20 T=2.00mm 1.017kg/m	
YLJ388A21 T=2.00mm 2.233kg/m		YLJ388A22 T=1.90mm 0.690kg/m		YLJ388A23 T=1.90mm 1.062kg/m	
YLJ388A24 T=1.90mm 1.108kg/m		YLJ388A25 T=1.90mm 1.073kg/m		YLJ388A26 T=1.90mm 1.109kg/m	

注：图中所示为标注厚度的理论重量，实际重量以过磅时的重量为准。

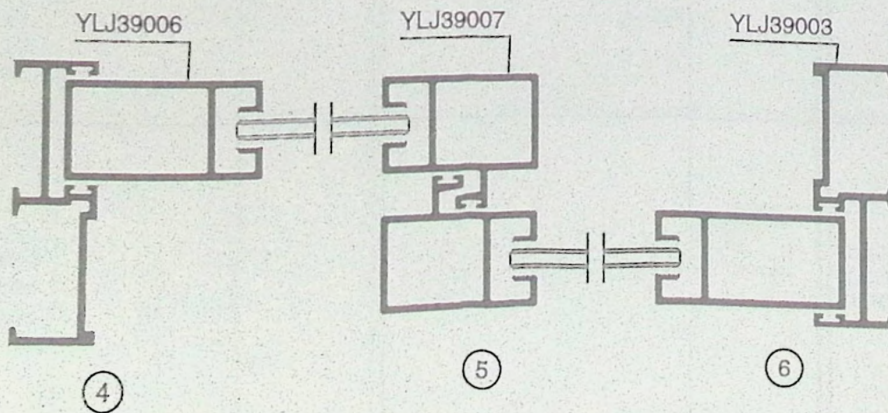
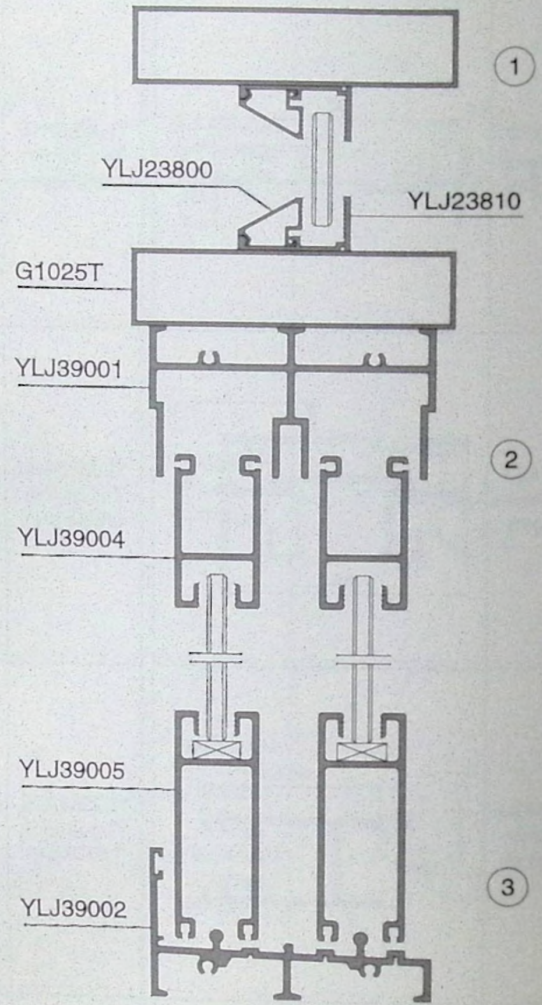
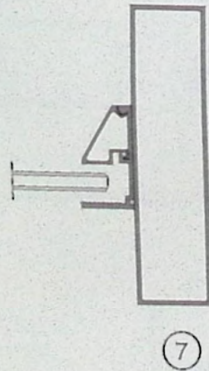
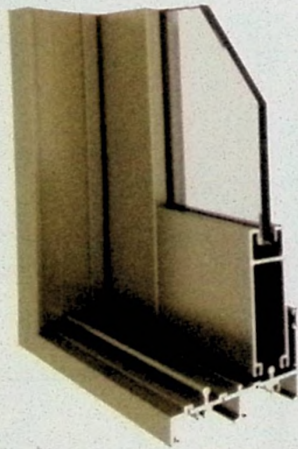

90系列推拉门结构图

Structure Diagram of Series 90 Sliding Door

永利坚铝材 YONGLIJIAN

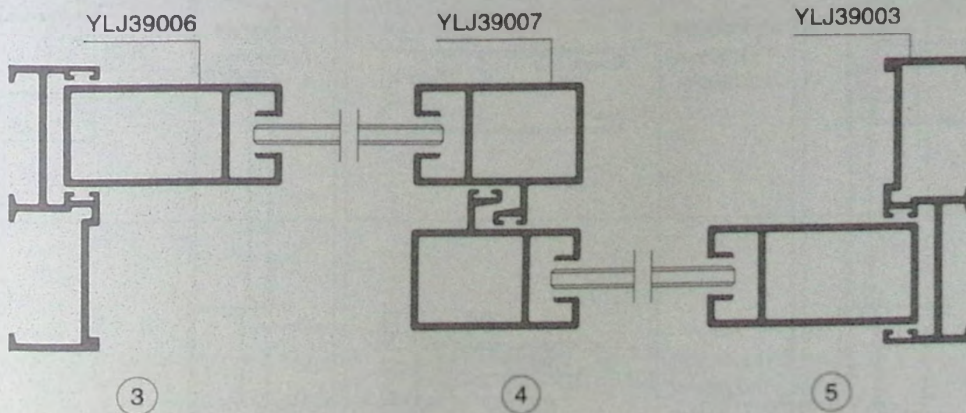
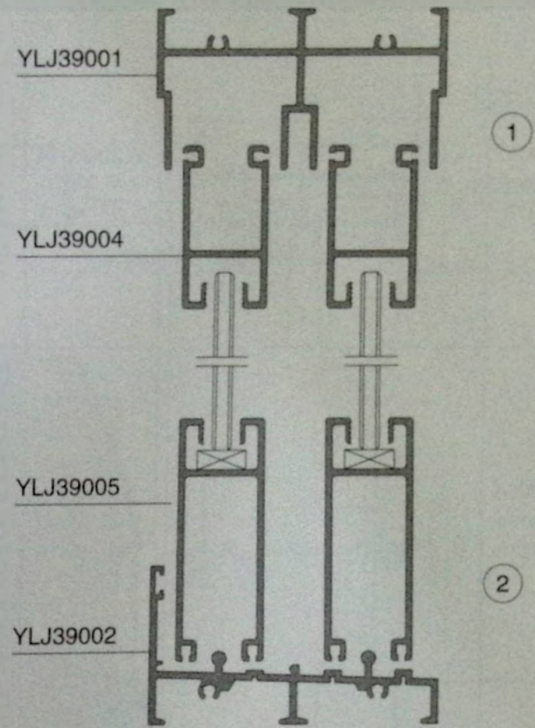
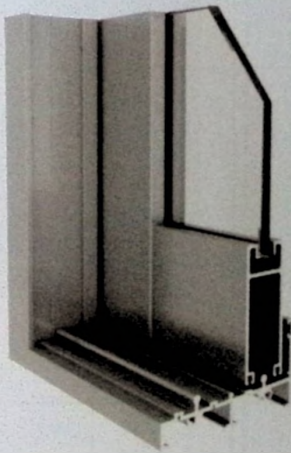



型号厚度 米重/kgm	产品图例	型号厚度 米重/kgm	产品图例	型号厚度 米重/kgm	产品图例
YLJ39001 T=2.10mm 1.651kg/m		YLJ39001A T=2.00mm 1.531kg/m		YLJ39002 T=2.10mm 1.387kg/m	
YLJ39002A T=2.00mm 1.089kg/m		YLJ39003 T=2.10mm 1.104kg/m		YLJ39003A T=2.00mm 0.978kg/m	
YLJ39004 T=2.00mm 0.868kg/m		YLJ39005 T=2.00mm 1.147kg/m		YLJ39006 T=2.00mm 1.151kg/m	
YLJ39006A T=2.00mm 1.137kg/m		YLJ39006B T=1.90mm 1.378kg/m		YLJ39007 T=2.00mm 1.143kg/m	
YLJ39007A T=2.00mm 1.147kg/m		YLJ39007B T=2.00mm 1.142kg/m			

注：图中所示为标注厚度的理论重量，实际重量以过磅时的重量为准。

82系列平开门结构图(双包)

Structure Diagram of Series 82 Casement Door(Double package)

永利坚铝材 YONGLIJIAN

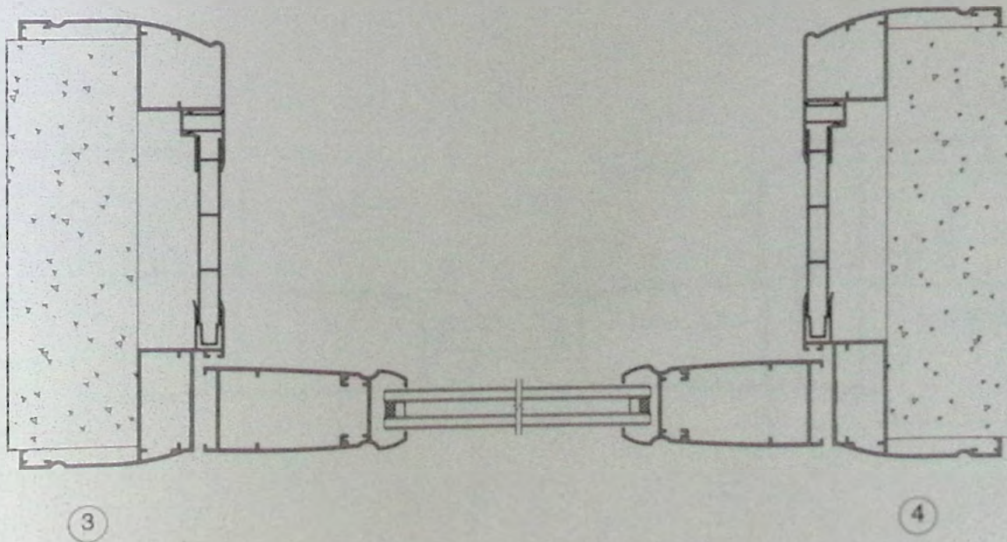
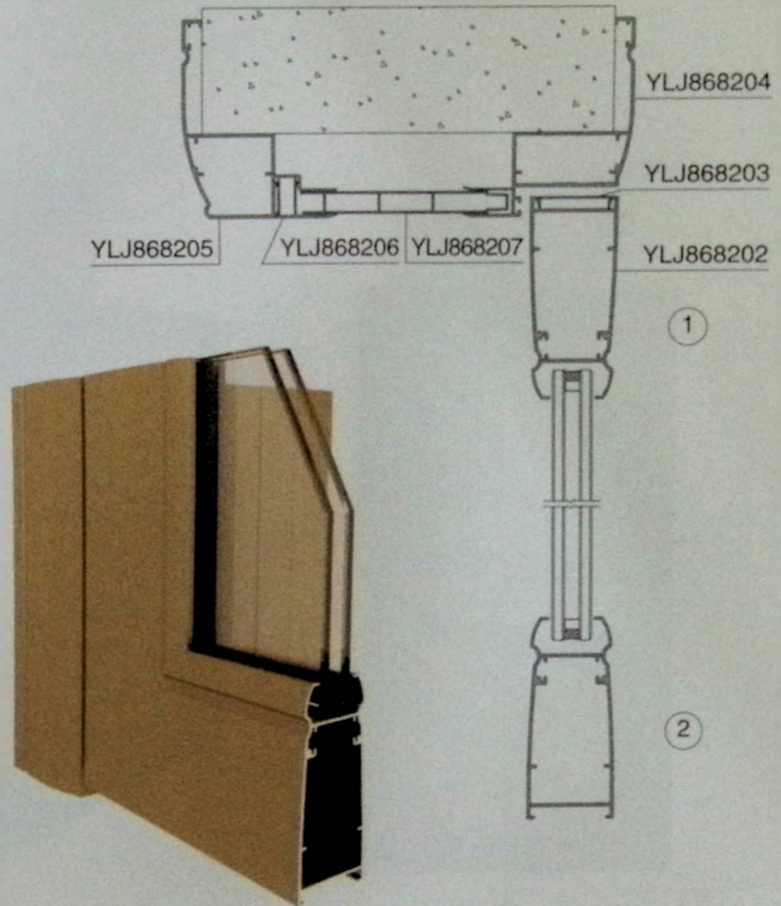

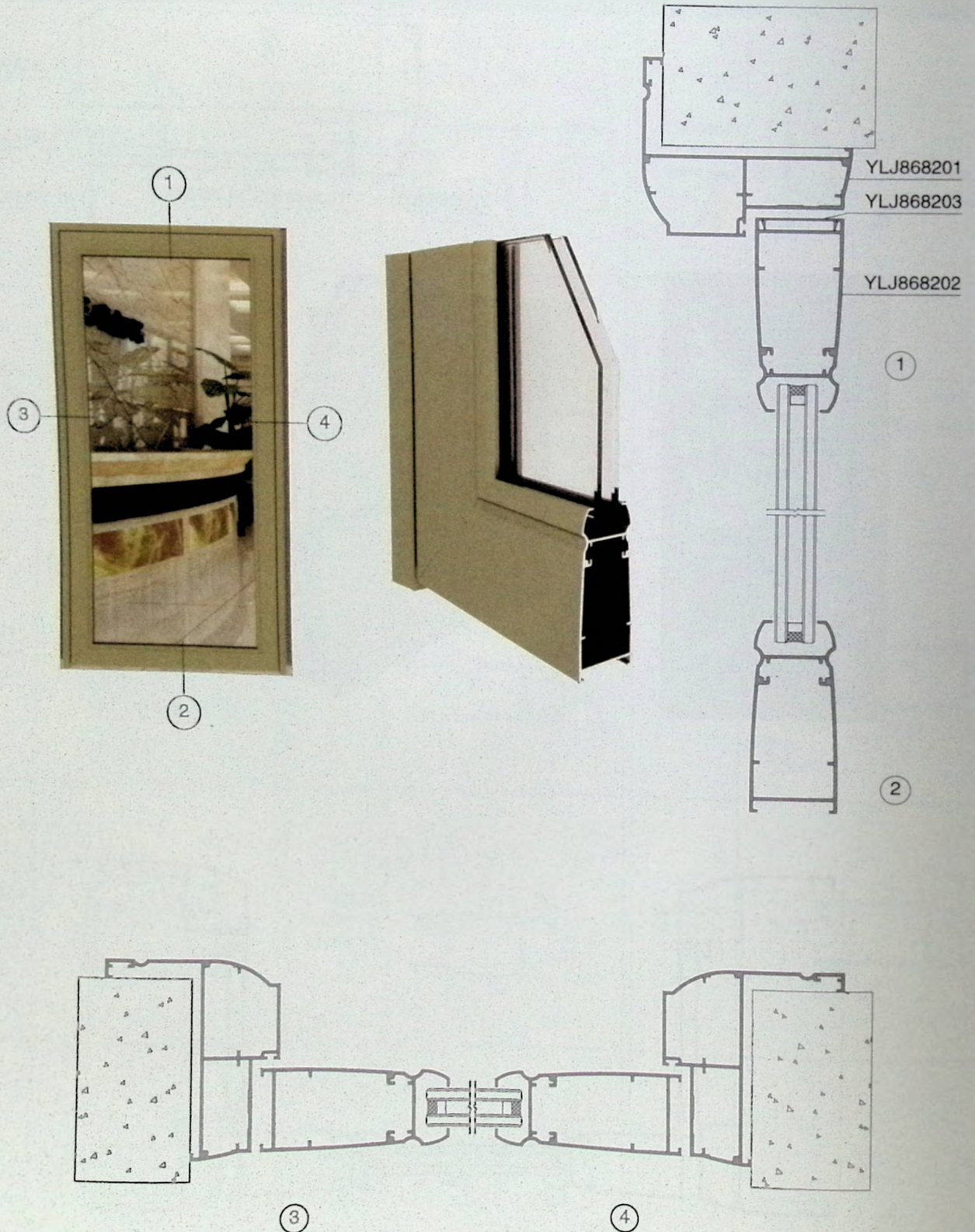

82系列门套结构图

Structure Diagram of Series 82 pocket Casement Door

永利坚铝材 YONGLIJIAN

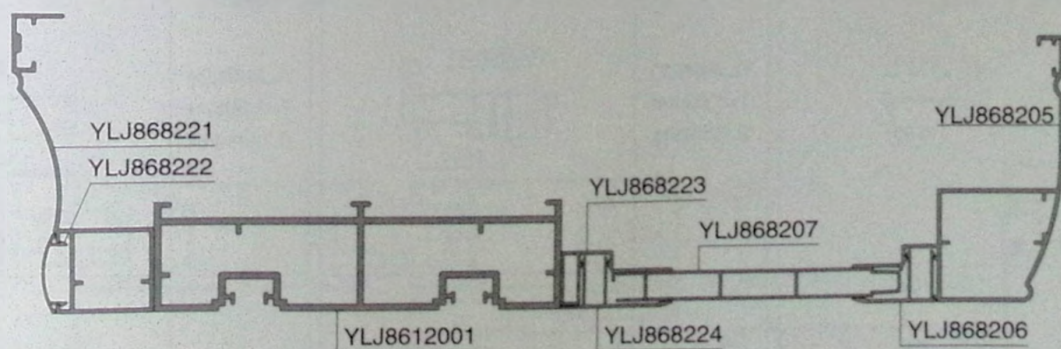
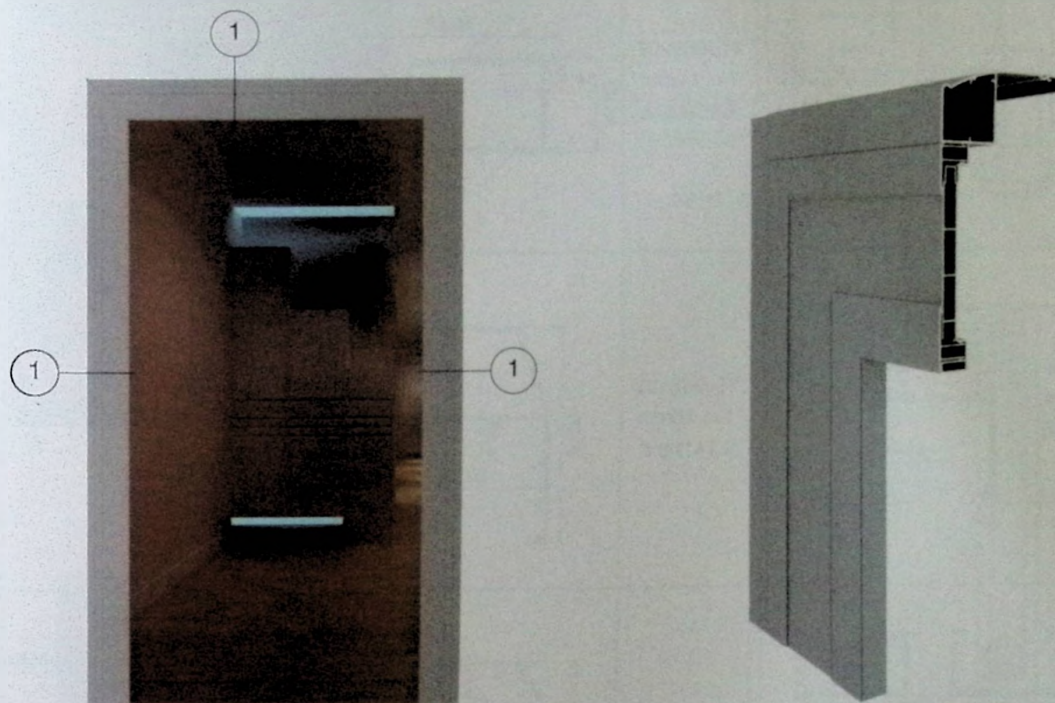

①



型号厚度 米重/kgm	产品图例	型号厚度 米重/kgm	产品图例	型号厚度 米重/kgm	产品图例
YLJ868201 T=1.20mm 1.072kg/m		YLJ868202 T=1.20mm 0.853kg/m		YLJ868203 T=0.80mm 0.083kg/m	
YLJ868204 T=1.20mm 0.821kg/m		YLJ868205 T=1.20mm 0.741kg/m		YLJ868206 T=1.00mm 0.128kg/m	
YLJ868207 T=0.80mm 0.431kg/m		YLJ868208 T=1.20mm 1.072kg/m		YLJ868221 T=1.20mm 0.685kg/m	
YLJ868222 T=0.70mm 0.072kg/m		YLJ868223 T=1.00mm 0.198kg/m		YLJ868224 T=1.00mm 0.148kg/m	

注：图中所示为标注厚度的理论重量，实际重量以过磅时的重量为准