

# PA66GF25 隔热条 Thermal Barrier Strip

设计制造专家 Design & Manufacture Expert

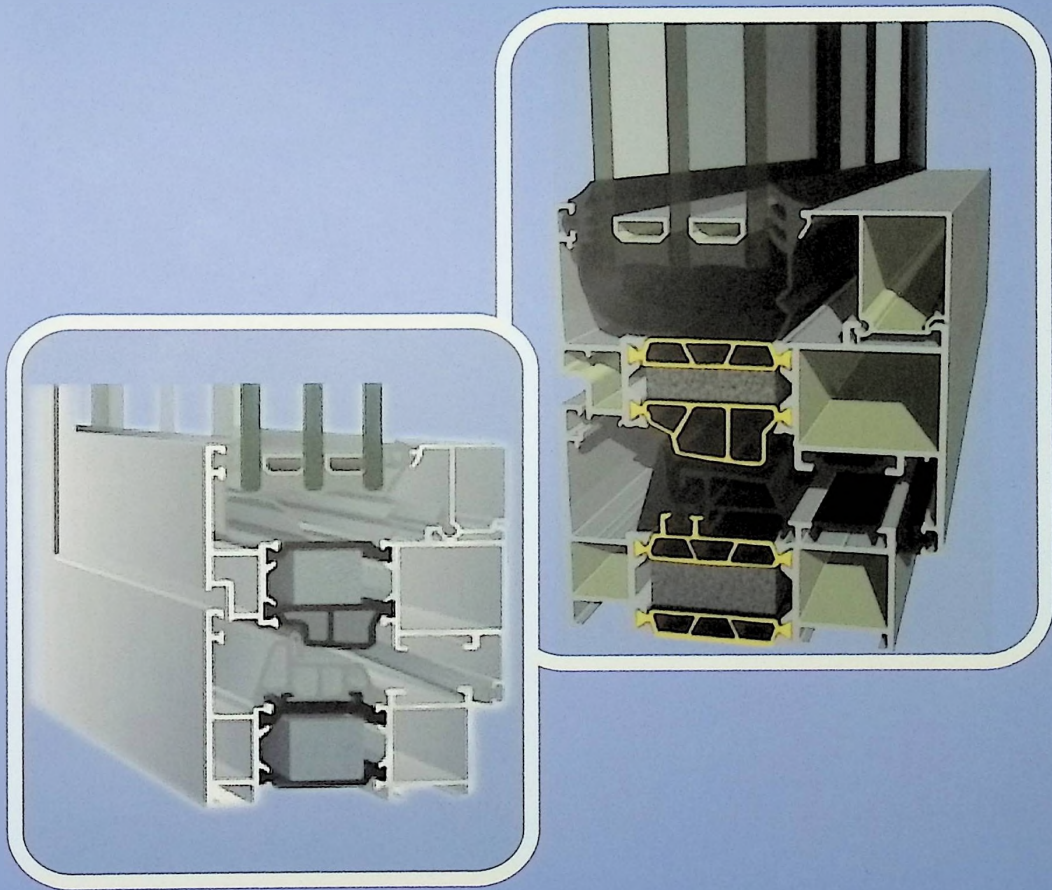

## 上海优泰装饰材料有限公司

Shanghai Youtai Decoration Materials Co.,Ltd

# 公司简介 Profile

优泰公司成立于2003年，是中国国内最早从事尼龙隔热条自主研发、生产的企业。随着优泰隔热条产品的问世，改变了尼龙隔热条全部依赖进口的局面，打破了国外产品的垄断。公司成立初期隔热条生产线为4条，全面启动门窗幕墙节能先驱事业。

2005年，公司从普陀区水产路搬迁至闵行区浦江镇建新村，隔热条生产线也由原来的4条逐步增加为15条，并且自主改性造粒，优泰品牌在国内市场开始传播开来。

2008年，随着市场需求的进一步扩大，公司从建新村搬迁至沈杜公路5877号，将全部隔热条生产线全部改为冷挤生产线，生产线逐步增加为35条，产品品质与国际接轨。

2011年，为把优泰品牌做大做强，公司斥资8000万元购买奉贤区金汇镇工业路1390号地块50亩，建立现代化生产厂房，购买先进设备及全自动生产线80条，建立研发中心，检测中心。

2013年，公司全部搬迁至奉贤区金汇镇工业路1390号，100余条的现代化生产线将优泰产能提升至年产量达2.5亿米隔热条，成为国内最大的隔热条生产企业，并开始自主研发设计门窗系统隔热条，全方位启动隔热条节能事业。

2020年5月，安徽生产基地开始投产，一期项目40多条全自动检测挤压生产线，为客户不断增加的需求提供了保障。

衷心感谢您对“优泰”品牌的信任与厚爱，公司以“优质服务，质量第一”为经营宗旨，本着诚信为本，互惠互利，多方共赢的经营理念，与新老客户建立长期、有效的合作方式、同广大客户共同进步、共谋发展。

Shanghai Youtai Decoration Material Co., Ltd was founded in 2003, is the earliest China engaged in domestic nylon insulation of independent research and development, production enterprises, with the UTC insulation product, change of nylon insulation all rely on imports, breaking the monopoly of foreign products. Company was established early insulation production line 4, start the door window and curtain wall energy-saving pioneer undertakings.

In 2005, the company from Putuo District aquatic road relocation to Minhang District Pujiang Zhen Jian Xin Cun, insulation lines from the original four gradually increased to 15, and independent modified granulation, UTC brand began to spread in the domestic market.

In 2008, with the further expansion of market demand, the company from the village relocation Shen Du Road No. 5877, hot stretch insulation production line into the cold extrusion production line, production line gradually increased to 35 and in line with international standards, the quality of the products.

In 2011, as the youtai brand bigger and stronger, the company invested 80000000 yuan to buy the Jinhui Town Industrial Road Fengxian District 1390 plots of land of 50 mu, building modern production plant, the purchase of advanced equipment and automatic production line 80, set up R & D center, testing center.

In 2013, the company relocated all Jinhui Town Industrial Road to Fengxian District No. 1390, more than 100 production lines will be enabled to increase capacity to annual production of 250000000 meters insulation, become the largest heat production enterprises, and independent R & D design window insulation, comprehensive start insulation energy-saving cause.

In May 2020, Anhui production base began to be put into operation, and more than 40 full-automatic detection extrusion production lines of the first phase project provided guarantee for the increasing demand of customers.

Thank you for your "youtai" brand of trust and love, the company with "quality service, quality first" for business purposes, the spirit of honesty, mutual benefit, win-win business philosophy, to establish long-term, effective ways of cooperation, with customers and common progress, and seek common development with new and old customers.

# 企业认证 Enterprise certification

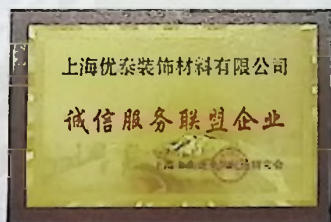
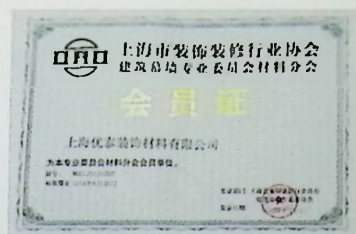
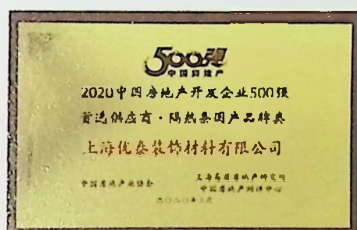



## 国内隔热条生产制造的领跑者

The leader of the domestic heat insulation strip production

公司成立于2003年，坐落于上海市奉贤区金汇园业，现拥有全世界最先进的100余条全自动检测装置尼龙隔热条生产线，拥有现代化的标准厂房45000多平方米，员工300多名，其中有多年从事专业设计开发技术人员40余名，2019年度生产PA66GF尼龙隔热条3亿多米。2020年5月，安徽生产基地开始投产，一期项目40多条全自动检测挤压生产线，为客户不断增加的需求提供了保障。

Founded in 2003, the company is located in jinhuiyuan industry, Fengxian District, Shanghai. Now it has more than 100 production lines of nylon insulation strips with the most advanced automatic detection devices in the world. It has a modern standard workshop of more than 45000 square meters and more than 300 employees. Among them, there are more than 40 technical personnel engaged in professional design and development for many years. In 2019, it will produce more than 300 million meters of PA66GF nylon heat insulation strips. In May 2020, Anhui production base began to be put into operation, and more than 40 full-automatic detection extrusion production lines of the first phase project provided guarantee for the increasing demand of customers.

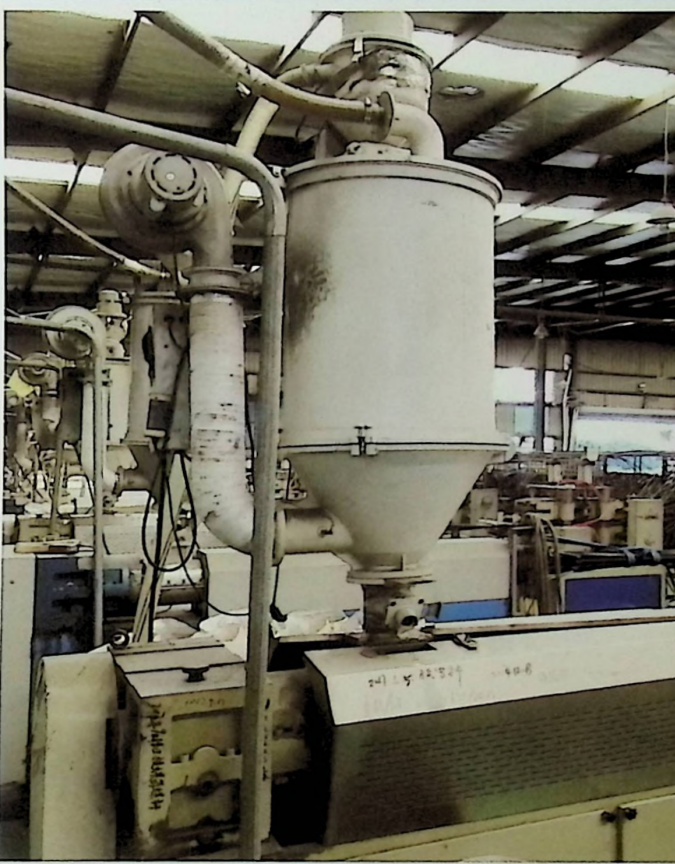
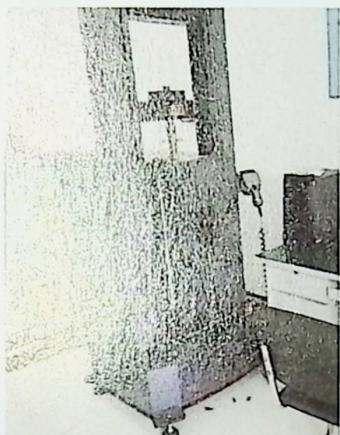
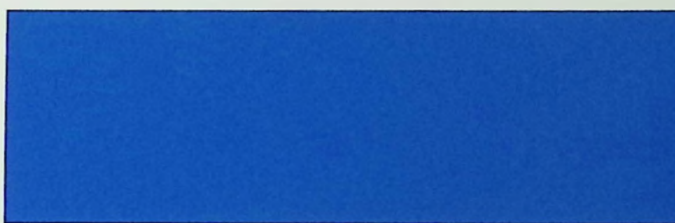

## 公司设备及业绩

### Company equipment and performance

截至目前为止公司拥有自主研发中心及检测中心，技术产品先进，产品及型号覆盖各类用途多达500多种，成功应用于上海世博场馆、上海虹桥机场、中石化（天津）、国家开发银行、上海环球金融中心、上海港务大厦等等，为上海市高新技术企业、守合同重信用企业。

So far the company has independent R & D center and test center, advanced technology products, products and models cover all use up more than 500 kinds, successfully applied in Shanghai World Expo venue, Shanghai Hongqiao Airport, Sinopec (Tianjin), the National Development Bank, the Shanghai world financial center, Shanghai Port Building, as high-tech enterprises in Shanghai City, Shou contract re credit enterprise.



# 产品优势 Competitive Advantages

优泰隔热条是由65%尼龙 (PA66) 加25%玻璃纤维 (GF) 的最佳隔热条原料所组成, 颜色为黑色。作为主要隔热部件, 适合于铝合金门窗、有框幕墙, 特别是对门窗的抗风压性、水密性、气密性三项主要性能起到决定性的作用。

The black Youtai thermal barrier strips are made from optimal materials consisting of 75% of polyamide nylon (Pa66) and 25% of GF. As a major thermal barrier strips unit, they can be applied to aluminum alloy doors and windows as well as frame supported curtain walls. Particularly, they play a decisive role in guaranteeing compression-resistance, water proofness and air tightness, which are the three main properties of doors and windows. Specifically, they have the following competitive advantages.

一、采用专业挤压技术玻璃纤维呈多项均匀分布, 强度高, 满足设计需要能保证隔热铝合金门窗、有框幕墙的长久稳定。

The strips have an evenly GF distribution under extrusion technology and secure long term stability of thermal barrier strips aluminum alloy doors and windows.

二、线膨胀系数与铝型材接近, 保证在阳光暴晒及严寒冷冻状况下隔热条与铝材持久、紧密结合始终紧密结合而不移位或脱落。

The linear expansion coefficient is about the same with that of aluminum, which will prevent the doors and windows from deformation or falling apart under the condition of extreme hotness and coldness.

三、加工温度高达235度, 完全满足先穿条后喷涂的工艺操作。

The processing temperature reaches as high as 235 degrees Celsius so as to achieve strip wearing before paint spraying.

四、尺寸精度小于0.05mm, 高尺寸精度便于开齿滚压加工, 也保证门窗幕墙的气密、水密和抗风压性能。

The dimensional accuracy is high with small changes of less than 0.05mm. The high-degree accuracy makes it easy to conduct teeth-making and roll extrusion and guarantees the air tightness, water proofness and wind and compression resistance of doors, windows and curtain walls.

五、优良的机械加工性能, 可紧固五金件。

The strips are excellently processed, which will fasten the furniture hardware.

六、具耐火、耐高温、耐化学腐蚀、抗老化、抗紫外等功能, 更环保节能, 使用寿命更长, 亦可回收利用。

It has such properties as fire-resistance, thermostability, corrosion resistance, aging resistance and uvioresistance. Therefore, they are environment friendly with a longer life span. Also, they can be recycled for reuse.

七、独特的配方和专用热稳定剂, 保证优泰隔热条的优良品质。

The unique and special thermal stabilizer ensures Youtai strips have an exceptional performance.

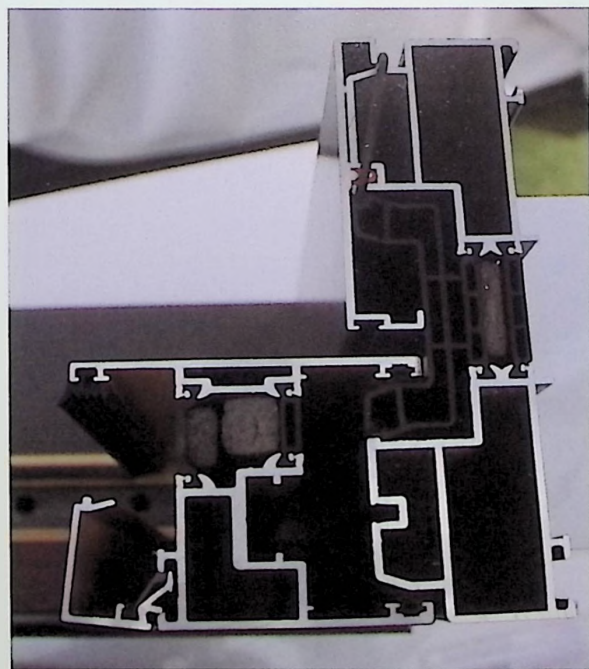

# 产品优势 Competitive Advantages

八、供货周期短：公司拥有140余条全自动生产线，先进的生产设备与成熟的生产工艺，保证在最短的时间将优质的产品交付客户。品种齐全，备有现货。

**Short delivery cycle:** the company has 140 automatic production lines, advanced production equipment and mature production technology, ensure the quality of products delivered to customers in the shortest time. Variety complete, with the spot.

九、选择余地大：产品规格多达500多种供客户选择，选择空间大。另可以根据客户需求，开发新模具，满客户实际需求。

**A wide range of choice:** Customers have a widerange of choices of over 300 kinds of products. Besides, we can develop new moulds at customers' demand and to theirsatisfaction.

十、产品供应：采用订单制生产，根据客户要求，可进行定尺生产，避免材料浪费，节约客户成本，同时提高生产效率。

**Convenient products supply:** products are made in accordance with the order. Therefore, we can produce customized products with particular sizes, so as to reduce the energy, lower cost for customers and increase productivity.



# 产品性能 Product performance

GB/T 23615.1-2017 铝合金建筑型材用辅助材料 第一部分：聚酰胺隔热条

GB/T 23615.1-2017 Accessorial materil for architectural aluminum alloy profiles Part1:Thermal barrier strip of polyamide.

中华人民共和国国家标准中要求的隔热条主要性能表  
The People's Republic of China national standard  
required insulation performance table.

项 目		标 要 求
密 度		$1.35 \pm 0.05 \text{ g/cm}^3$
DSC 熔融峰温		$\approx 255^\circ\text{C}$
玻璃纤维含量		$25 \pm 2.5\%$
轴钉应力开裂性能		孔口无开裂
邵氏硬度 (H <sub>D</sub> )		$80 \pm 5$
低温无缺口冲击强度 ( $-30^\circ\text{C} \pm 2^\circ\text{C}$ )		$\geq 50 \text{ kJ/m}^2$
室温纵向抗拉特征值 ( $23^\circ\text{C} \pm 2^\circ\text{C}$ )		$\geq 90 \text{ MPa}$
室温纵向拉伸断裂伸长率		$\geq 3\%$
室温纵向拉伸弹性模量		$\geq 4500 \text{ MPa}$
室温横向抗拉特征值 ( $23^\circ\text{C} \pm 2^\circ\text{C}$ )	I 型 (截面高度 < 20mm)	$\geq 90 \text{ MPa}$
	I 型 (截面高度 $\geq 20\text{mm}$ )	$\geq 80 \text{ MPa}$
	非 I 型	$\geq 25 \text{ MPa}$
高温横向抗拉特征值 ( $90^\circ\text{C} \pm 2^\circ\text{C}$ )	I 型 (截面高度 < 20mm)	$\geq 55 \text{ MPa}$
	I 型 (截面高度 $\geq 20\text{mm}$ )	$\geq 45 \text{ MPa}$
	非 I 型	$\geq 20 \text{ MPa}$
低温横向抗拉特征值 ( $-30^\circ\text{C} \pm 2^\circ\text{C}$ )	I 型 (截面高度 < 20mm)	$\geq 90 \text{ MPa}$
	I 型 (截面高度 $\geq 20\text{mm}$ )	$\geq 80 \text{ MPa}$
	非 I 型	$\geq 25 \text{ MPa}$
耐水性能	I 型 (截面高度 < 20mm)	横向抗拉特征值 $\geq 85 \text{ MPa}$
	I 型 (截面高度 $\geq 20\text{mm}$ )	横向抗拉特征值 $\geq 75 \text{ MPa}$
	非 I 型	横向抗拉特征值 $\geq 22 \text{ MPa}$
热老化性能	I 型 (截面高度 < 20mm)	横向抗拉特征值 $\geq 60 \text{ MPa}$
	I 型 (截面高度 $\geq 20\text{mm}$ )	横向抗拉特征值 $\geq 55 \text{ MPa}$
	非 I 型	横向抗拉特征值 $\geq 20 \text{ MPa}$

GB/T  
23615.1-2017

"a" 该值代表I型条。

"a" The values represent the type I Article





性能指标 (Youtai thermal barrier strips Performance index)

GB/T  
23615.1-2017

检验项目 Test Item	单位 Unit	检验值 Test Result
密度 Density	g/cm <sup>3</sup>	1.31
邵氏硬度Hd Shore Hardness (HD)	/	81.2
低温无缺口冲击强度 (-30℃ ± 2℃) Unnotched Impact Strength at Low Temperature (-30℃ ± 2℃)	kJ/m <sup>2</sup>	51.2
室温纵向抗拉特征值 (23℃ ± 2℃) Characteristic Value of Tensile Strength at Room Temperature (23℃ ± 2℃)	MPa	92
室温纵向拉伸断裂伸长率 Elasticity at Breaking at Room Temperature	%	7.4
室温纵向拉伸弹性模量 Modulus of Elasticity at Room Temperature	MPa	4943
室温横向抗拉特征值 (23℃ ± 2℃) Characteristic Value of Transverse Tensile Strength at Room Temperature (23℃ ± 2℃)	MPa	95
高温横向抗拉特征值 (90℃ ± 2℃) Characteristic Value of Transverse Tensile Strength at High Temperature (90℃ ± 2℃)	MPa	58
低温横向抗拉特征值 (-30℃ ± 2℃) Characteristic Value of Transverse Tensile Strength at Low Temperature (-30℃ ± 2℃)	MPa	90
耐水试验 (沸水试验) Water Resistance Test (boiling water test)	MPa	105
轴钉应力开裂试验 Stress Crack Test	/	孔口无裂纹 No crack at aperture
玻璃纤维含量 Glass Fiber Content	%	25 ± 2.5%
DSC熔融峰温 Melting Peak Temperature (Differential Scanning Calorimetry)	°C	259.9
热老化试验 (1000h) Thermal Ageing Test (1000h)	MPa	81

"a" 该值代表型条。 "a" The values represent the type I Article

# 产品规格 Product Specifications

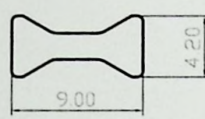
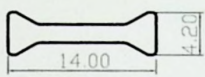
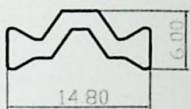
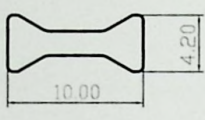
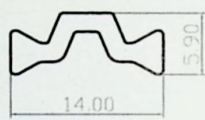
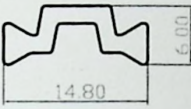
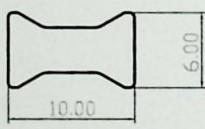
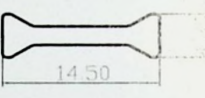
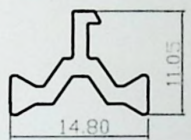
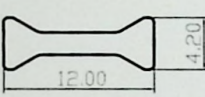
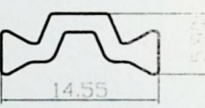
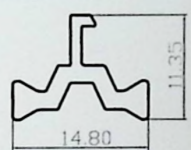
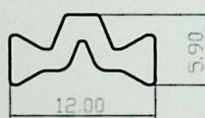
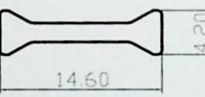
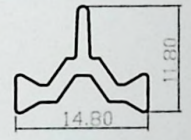
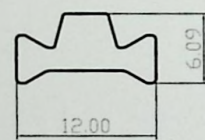
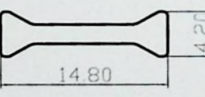
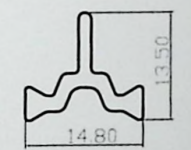
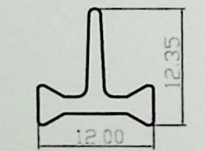
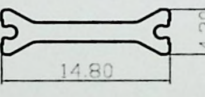
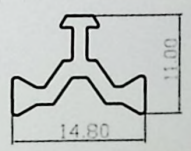
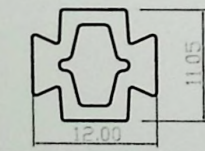
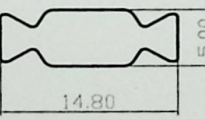
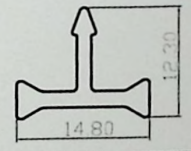
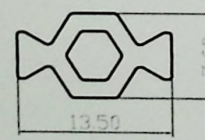
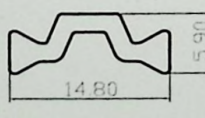
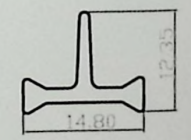
产品编号	断面图	产品编号	断面图	产品编号	断面图
YT-I9*4.2		YT-I14*4.2		YT-C14.8*6(D)	
YT-I10*4.2		YT-C14*5.9		YT-C14.8*6(X)	
YT-I10*6		YT-I14.5*4.2		YT-CF14.8*11.05	
YT-I12*4.2		YT-C14.55*5.9		YT-CF14.8*11.35	
YT-C12*5.9		YT-I14.6*4.2		YT-CI14.8*11.8	
YT-C12*6.09		YT-I14.8*4.2		YT-CI14.8*13.5	
YT-T12*12.35		YT-I14.8*4.2(X)		YT-CT14.8*11	
YT-K12*11.05		YT-I14.8*5		YT-T14.8*12.3J	
YT-K13.5*7.6		YT-C14.8*5.9		YT-T14.8*12.35	

# 产品规格 Product Specifications

产品编号	断面图	产品编号	断面图	产品编号	断面图
YT-T14.8*10.39		YT-K14.8*12.84J		YT-CT15*10.8	
YT-T14.8*14.4		YT-S14.8*7.9		YT-I15.8*4.2	
YT-T14.8*14.80		YT-I15*4.2		YT-C15.8*6	
YT-T14.8*14.90		YT-C15*6.1		YT-I16*4.2	
YT-T14.8*18.6		YT-C15*6.2		YT-C16*6	
YT-T14.8*12.5W		YT-C15*6.3		YT-CF16*11	
YT-T14.8*20.65		YT-CI15*11.9J		YT-CH16*7.4	
YT-IC14.8*6.4		YT-CI15*12.1P		YT-CI16*12.5JP	
YT-K14.8*7.6		YT-CT15*10.5		YT-CI16*14.92P	



# 产品规格 Product Specifications

产品编号	断面图	产品编号	断面图	产品编号	断面图
YT-T16*1235		YT-CH17.5*11.1		YT-C18*15.2W	
YT-K16*7.6		YT-C17.5*14.2		YT-C18*15.25	
YT-I16.8*4.2		YT-I18*4.2		YT-C18*11.1	
YT-C17*6		YT-C18*6		YT-T18*12.35	
YT-C17*12.4P		YT-C18*6Y		YT-K18*7.4	
YT-K17*10.5		YT-CH18*10		YT-K18*7.68	
YT-K17*10.7		YT-C18*13		YT-I18.6*4.2	
YT-C17.5*6.3Y		YT-C18*13.4W		YT-I18.6*6(Y)	
YT-C17.5*6.67Y		YT-C18*14.52P		YT-C18*6	

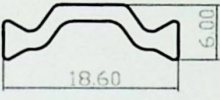
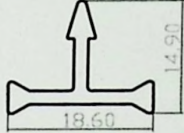
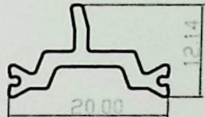
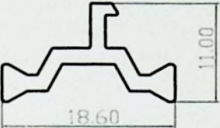
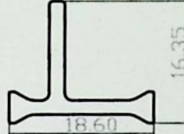
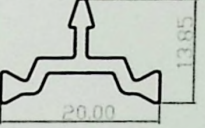
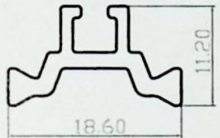
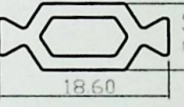
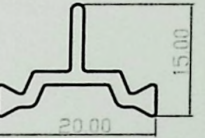
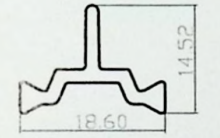
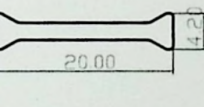
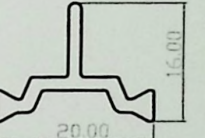
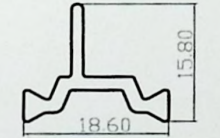
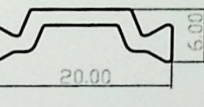
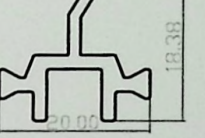
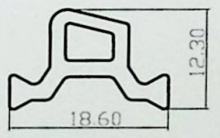
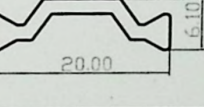
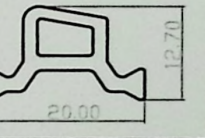
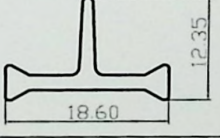
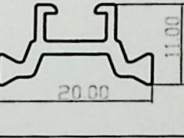
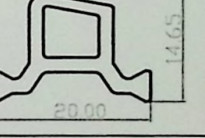
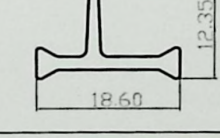
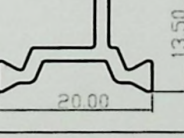
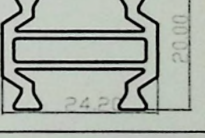
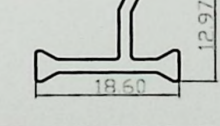
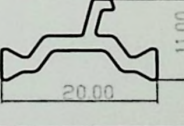
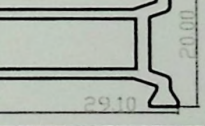
# 产品规格 Product Specifications

产品编号	断面图	产品编号	断面图	产品编号	断面图
YT-C18.6*6Y		YT-T18.6*14.9J		YT-CI20*12.14PW	
YT-CF18.6*11P		YT-T18.6*16.35P		YT-CI20*13.85J	
YT-CF18.6*11.2		YT-K18.6*4.2		YT-CI20*15	
YT-T18.6*14.52		YT-I20*4.2		YT-CI20*16	
YT-CI18.6*15.8P		YT-C20*6		YT-CI20*18.38W	
YT-CK18.6*12.3		YT-C20*6.1		YT-CK20*12.7	
YT-T18.6*12.35		YT-CH20*11		YT-CK20*14.65	
YT-T18.6*12.35P		YT-CI20*13.5P		YT-CK20*24.2	
YT-T18.6*12.97PW		YT-CF20*11PW		YT-CK20*29.1	

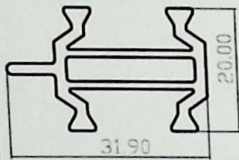
# 产品规格 Product Specifications

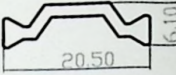
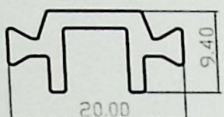
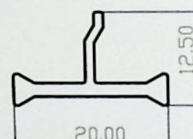
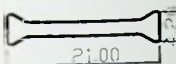
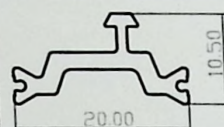
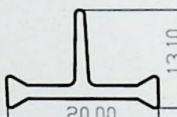
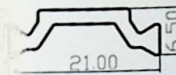
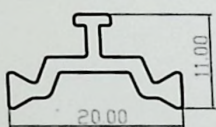
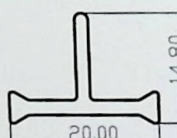
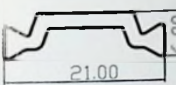
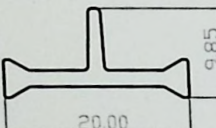
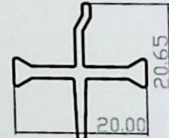
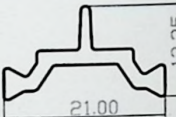
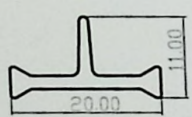
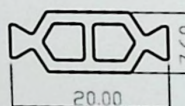
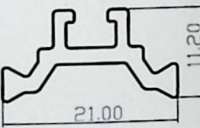
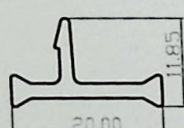
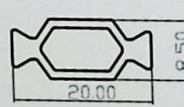
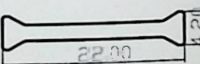
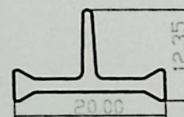
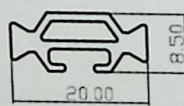
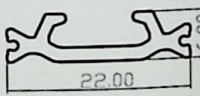
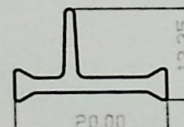
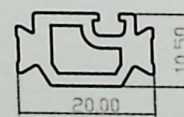
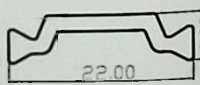
产品编号	断面图	产品编号	断面图	产品编号	断面图
YT-CK20*31.9		YT-T20*12.9		YT-C20.5*6.1	
YT-CN20*9.4		YT-T20*12.5W		YT-T21*12.2	
YT-CT20*10.5P		YT-T20*13.1		YT-C21*6.5	
YT-CT20*11		YT-T20*14.8		YT-C21*6(X)	
YT-T20*9.85		YT-T20*20.65		YT-CI21*12.35	
YT-T20*11		YT-K20*7.6		YT-CH21*11.2	
YT-T20*11.85P		YT-K20*8.5		YT-J22*4.2	
YT-T20*12.35		YT-K20*8.5Y		YT-IC22*6	
YT-T20*12.35P		YT-K20*10.5		YT-C22*6	

# 产品规格 Product Specifications

产品编号	断面图	产品编号	断面图	产品编号	断面图
YT-C22*6Y		YT-IH24*6.23		YT-CF24*11.1P	
YT-CF22*10.8P		YT-C24*6		YT-CF24*11.3P	
YT-C22*11.6P		YT-C24*6(GD)		YT-CH24*11.2	
YT-CI22*12.4P		YT-C24*6(X)		YT-CH24*11.27	
YT-T22*12.35P		YT-C24*6(Y)		YT-CH24*14.17	
YT-C22.5*6		YT-C24*6.1Y		YT-CI24*12P	
YT-C22.5*6.3		YT-C24*6.2		YT-CI24*12.1P	
YT-I24*4.2		YT-CF24*10.9P		YT-CI24*12.35P	
YT-I24*4.2Y		YT-CF24*11P		YT-CI24*12.4P	

# 产品规格 Product Specifications

产品编号	断面图	产品编号	断面图	产品编号	断面图
YT-CI24*14.5JP		YT-CT24*10.5		YT-C24.8*5(X)	
YT-CI24*14.8		YT-CT24*11P		YT-CH24.8*10.8	
YT-CI24*15W		YT-T24*10.39P		YT-CI24.8*12.35P	
YT-CI24*18.17W		YT-T24*12.35		YT-I25*4.2	
YT-CK24*12.35		YT-T24*12.35P		YT-I25*6Y	
YT-C2K24*13		YT-T24*15JP		YT-C25*6	
YT-CK24*14.65		YT-K24*8.5		YT-CH25*10.8	
YT-CN24*9.4		YT-K24*8.5Y		YT-CI25*12.35	
YT-CN24*10.85		YT-3K24*7.6		YT-C2K25*13	



# 产品规格 Product Specifications

产品编号	断面图	产品编号	断面图	产品编号	断面图
YT-C2K25*16.3		YT-CI25.3*12.5PW		YT-K26*10.5Y	
YT-C25*13.5		YT-CK25.3*14.9		YT-C27*6	
YT-T25*12.35		YT-CT25.3*11P		YT-C27*5.94	
YT-T25*15.27J		YT-I26*4.2		YT-CH27*10.5	
YT-K25*10		YT-C26*6		YT-CH27*10.94	
YT-K25*10Y		YT-CI26*12.5P		YT-CI27*12.4P	
YT-I25.3*4.2		YT-CI26*14.92P		YT-C2K27*13.1	
YT-C25.3*6		YT-CT26*11P		YT-CT27*10.8P	
YT-CH25.3*10.9		YT-K26*10.5		YT-C27.5*6	

# 产品规格 Product Specifications

产品编号	断面图	产品编号	断面图	产品编号	断面图
YT-C27.5*6.3Y		YT-CH28*11		YT-CK28*11.8	
YT-CH27.5*11.1		YT-CH28*11.6		YT-CN28*11.6	
YT-CI27.5*14.2P		YT-CH28*14.27		YT-CT28*10.5P	
YT-CK27.5*15		YT-CH28*18.8		YT-CT28*10.74	
YT-I28*4.2		YT-CI28*12.1PW		YT-CT29*10.4	
YT-C28*6		YT-CI28*13.2W		YT-H3K29*14.9	
YT-C28*6Y		YT-CI28*13.4W		YT-I30*4.2	
YT-C28*6.2Y		YT-CK28*12.35		YT-C30*6	
YT-CF28*10.7		YT-CK28*20.27		YT-C30*6Y	

# 产品规格 Product Specifications

产品编号	断面图	产品编号	断面图	产品编号	断面图
YT-C30*6.2		YT-CN30*13.5		YT-CF32*11.63P	
YT-C30*6.3		YT-CO30*8		YT-CH32*13.3	
YT-C30*18.57		YT-C2T30*13		YT-CK32*14	
YT-CH30*11.2		YT-T30*13.4		YT-C2K32*15.57	
YT-CI30*13P		YT-IC31.5*6.9		YT-C3K32*15.1	
YT-CI30*14.5JP		YT-IB2*4.2		YT-C3K32*16.50	
YT-CIN30*19.85		YT-IC32*6.5		YT-CO32*8.2	
YT-CK30*14.7		YT-C32*6		YT-CT32*10.8P	
YT-CK30*33.2		YT-C32*6.09		YT-CT32*11	

# 产品规格 Product Specifications

产品编号	断面图	产品编号	断面图	产品编号	断面图
YT-HK32*11.2		YT-CI33*12.1P		YT-CI33*11.9	
YT-HK32*12		YT-CIN33*17.68		YT-CI33*13.1	
YT-HK32*12.35		YT-CT33*10.5P		YT-CN34*10.55	
YT-3K32*20		YT-CTN33*16.08		YT-CN34*10.75	
YT-C32.5*6		YT-CN33*11.58		YT-CN34*16.2	
YT-C32.5*6.3		YT-C34*6		YT-C2K34*14.15	
YT-CH32.5*11.1		YT-C34*6.4		YT-C2K34*21.9	
YT-I33*4.2(X)		YT-CF34*10.7		YT-HK34*8	
YT-C33*6(X)		YT-CF34*11.4		YT-C35*6.3	

# 产品规格 Product Specifications

产品编号	断面图
YT-C35.3*6	
YT-C37*6.3	
YT-C37*15.0	
YT-H3K35.3*22.2	
YT-HK35.3*6.3	
YT-HK35.3*11.2	
YT-HK35.3*13.7	
YT-CTN36*13.51	
YT-C3K36*16.52	

产品编号	断面图
YT-C37*6	
YT-C2T37*10.8	
YT-C3K37*15.1	
YT-C3K37.5*6.3	
YT-C38*6.3(Y)	
YT-CN38*10.7	
YT-C3K38*9.35	
YT-C2K38*14.76	
YT-CH41*10.95	

# 产品规格 Product Specifications

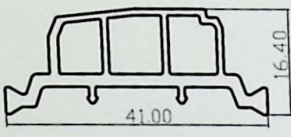
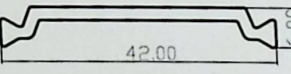
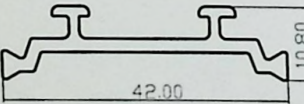
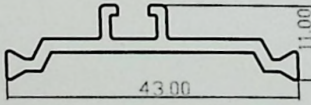
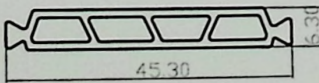
产品编号	断面图
YT-C3K41*16.4	
YT-C42*6	
YT-C2T42*10.8P	
YT-CH43*11	
YT-HK45.3*6.3	

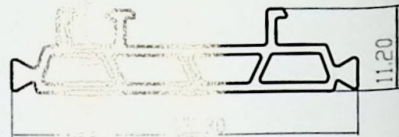
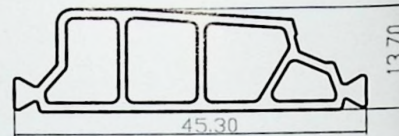
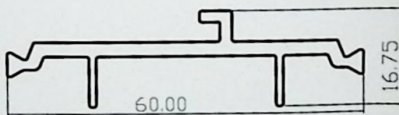
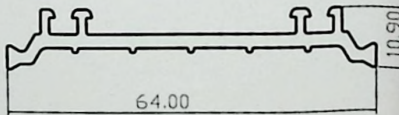
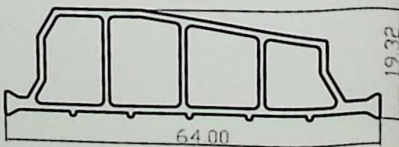
产品编号	断面图
YT-HK45.3*11.2	
YT-HK45.3*13.7	
YT-CF60*16.75	
YT-CH64*10.9	
YT-C4K64*19.32	

# 产品规格 Product Specifications

产品编号	断面图	产品编号	断面图	产品编号	断面图
YT-SM7*5		YT-SM11.35*7		YT-SM14.95*8	
YT-SM7.36*5.96		YT-SM12.6*14.4		YT-SM15*14.4	
YT-SM7.5*3.7		YT-SM12.94*7		YT-SM15.46*6.6	
YT-SM8.35*8.08		YT-SM12.94*9.39		YT-SM16*7.3	
YT-SM9.75*5		YT-SM12.95*10.26		YT-SM16.05*9.45	
YT-SM9.8*5.75		YT-SM13.11*8.53		YT-SM16.7*10.94	
YT-SM9.8*5.95		YT-SM14.5*9.5		YT-SM16.7*11	
YT-SM10*10		YT-SM14.6*7.3		YT-SM17*4.5	
YT-SM11.17*9.82		YT-SM14.6*10.4		YT-SM17.03*10	

# 产品规格 Product Specifications

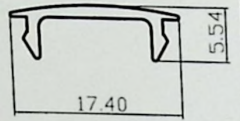
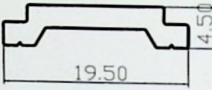
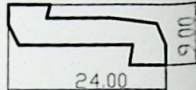
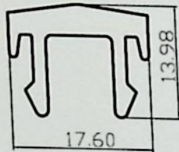
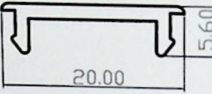
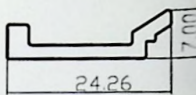
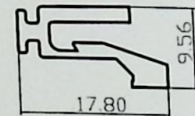
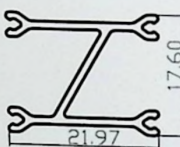
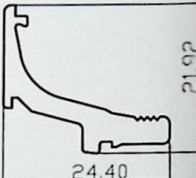
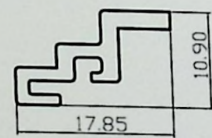
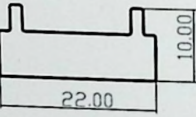
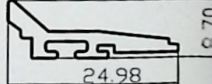
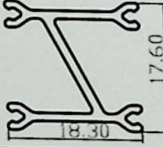
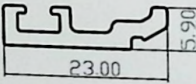
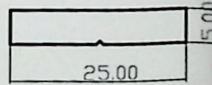
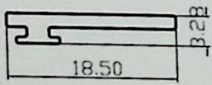
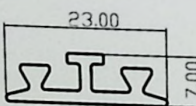
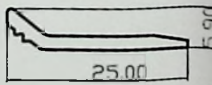
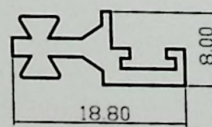
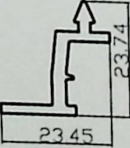
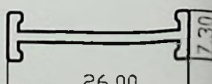
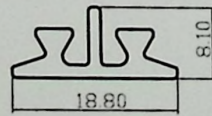
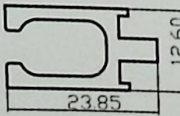
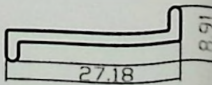
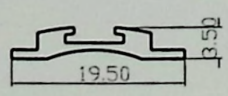
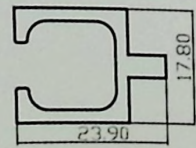
产品编号	断面图	产品编号	断面图	产品编号	断面图
YT-SM17.4*5.54		YT-SM19.5*4.5		YT-SM24*9	
YT-SM17.6*13.98		YT-SM20*5.6		YT-SM24.26*7	
YT-SM17.8*9.56		YT-SM21.97*17.6		YT-SM24.4*21.92	
YT-SM17.85*10.9		YT-SM22*10		YT-SM24.98*8.7	
YT-SM18.3*17.6		YT-SM23*5.9		YT-SM25*5	
YT-SM18.5*3.28		YT-SM23*7		YT-SM25*5.9	
YT-SM18.8*8		YT-SM23.74*23.45		YT-SM26*7.3	
YT-SM18.8*8.1		YT-SM23.85*12.6		YT-SM27.18*8.91	
YT-SM19.5*3.5		YT-SM23.9*17.8			

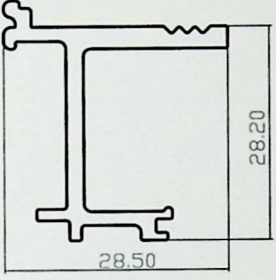
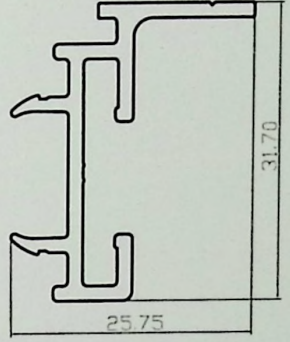
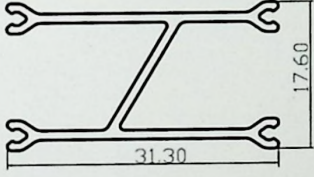
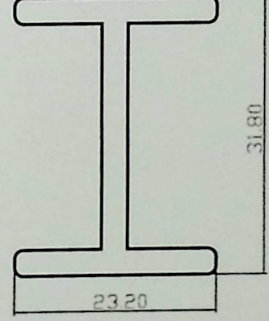
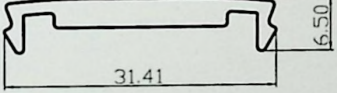
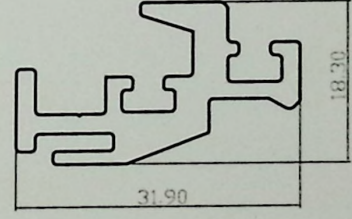
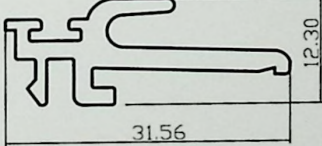
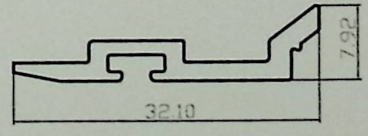
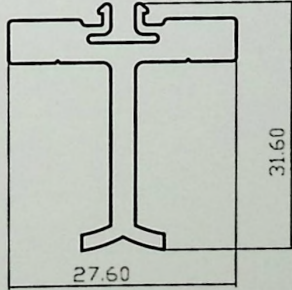

# 产品规格 Product Specifications

产品编号	断面图	产品编号	断面图
YT-SM28.5*26.2		YT-SM31.7*25.75	
YT-SM31.3*17.6		YT-SM31.8*23.2	
YT-SM31.41*6.5		YT-SM31.9*18.3	
YT-SM31.56*12.3Y		YT-SM32.1*7.92	
YT-SM31.6*27.6			

# 产品规格 Product Specifications

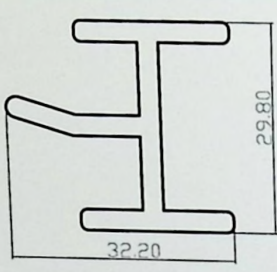
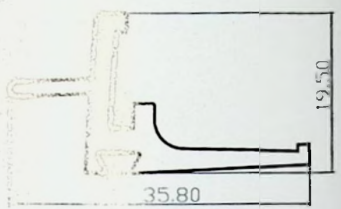
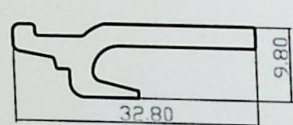
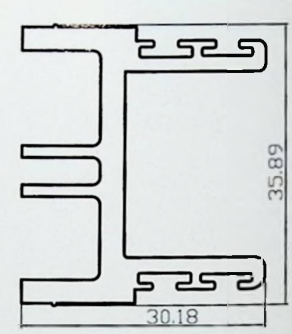
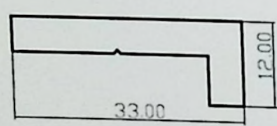
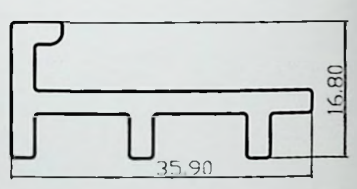
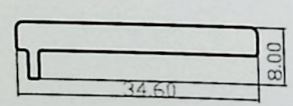
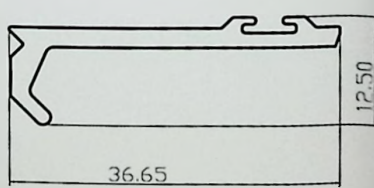
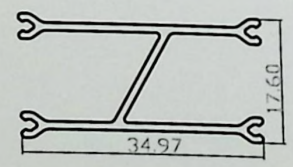
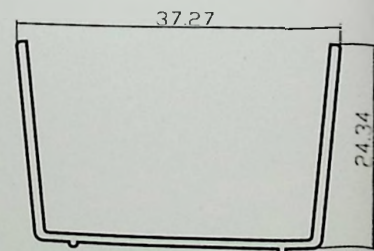
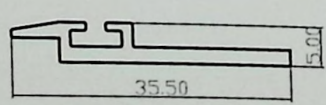
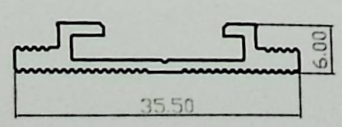
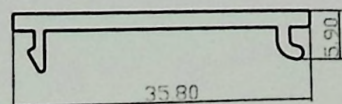
产品编号	断面图	产品编号	断面图
YT-SM32.2*29.8		YT-SM35.8*19.5	
YT-SM32.8*9.8		YT-SM35.89*30.18	
YT-SM33*12		YT-SM35.9*16.8	
YT-SM34.6*8		YT-SM36.65*12.5	
YT-SM34.97*17.6		YT-SM37.27*24.34	
YT-SM35.5*5			
YT-SM35.5*6			
YT-SM35.8*5.9			

# 产品规格 Product Specifications

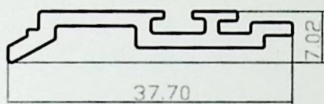
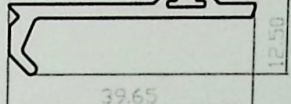
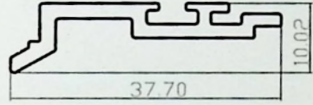
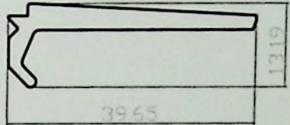
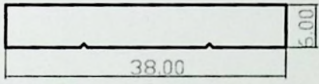
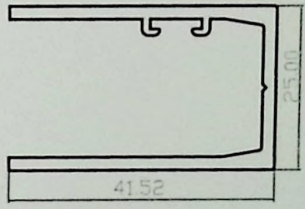
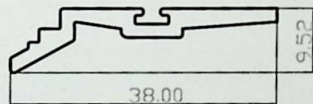
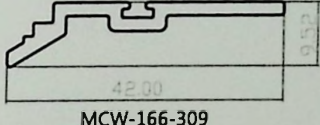
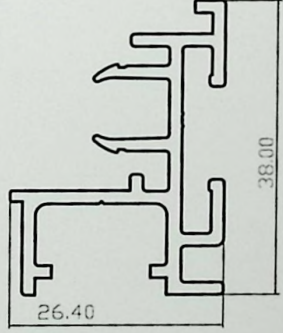
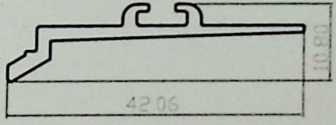
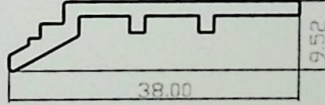
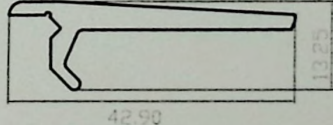
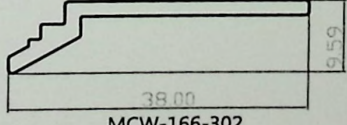
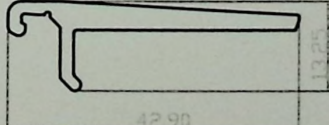
产品编号	断面图	产品编号	断面图
YT-SM37.7*7.02		YT-SM39.65*12.5	
YT-SM37.7*10.02		YT-SM39.65*13.19	
YT-SM38*6		YT-SM41.52*25	
YT-SM38*9.52		YT-SM42*9.52Y	
YT-SM38*26.4		YT-SM42.06*10.8	
YT-SM38*9.52Y		YT-SM42.9*13.25	
YT-SM38*9.52Y2		YT-SM42.9*13.25Y	

# 产品规格 Product Specifications

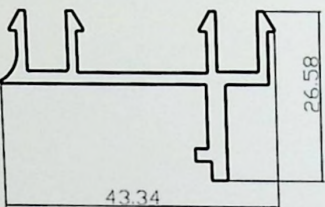
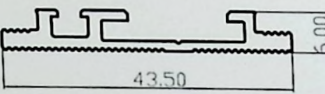
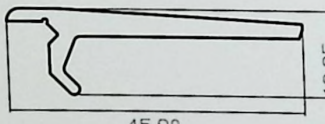
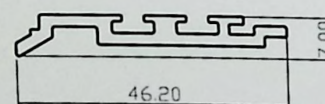
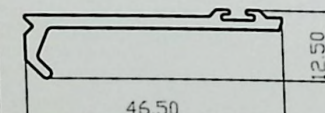
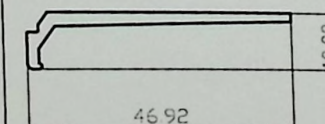
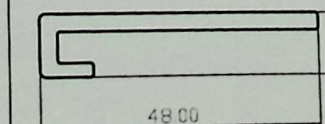
产品编号	断面图
YT-SM43.34*26.58	
YT-SM43.5*6	
YT-SM45.9*13.25	
YT-SM46.2*7	
YT-SM46.5*12.5	
YT-SM46.92*10	
YT-SM48*10.7	

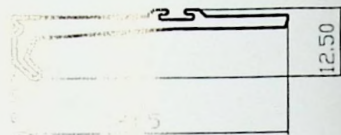
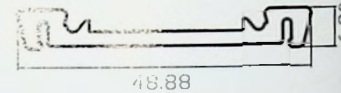
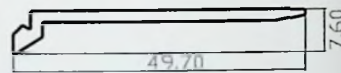
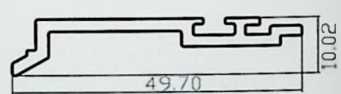
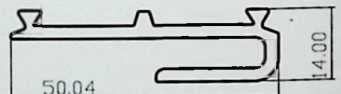
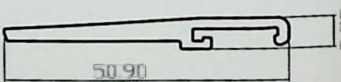
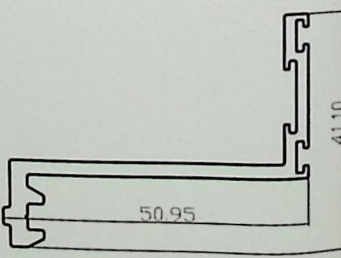
产品编号	断面图
YT-SM48.65*12.5	
YT-SM48.88*6.8	
YT-SM49.7*7.6	
YT-SM49.7*10.02	
YT-SM50.04*14	
YT-SM50.9*5.75	
YT-SM50.95*41.1	

# 产品规格 Product Specifications

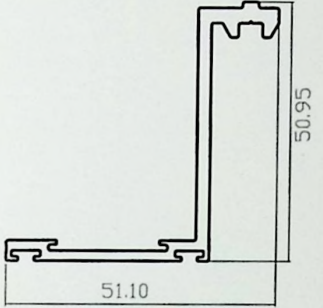
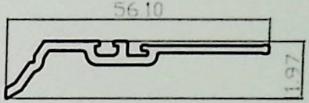
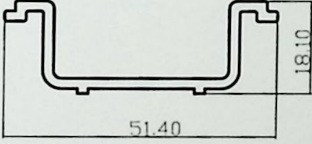
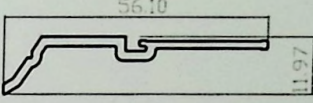
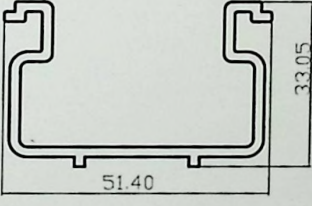
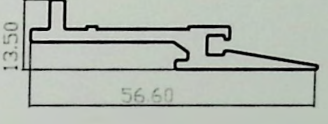
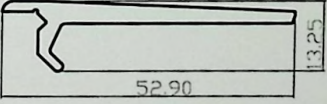
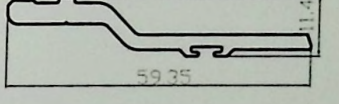
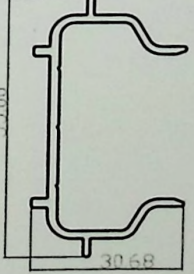
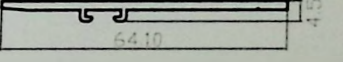
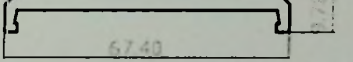
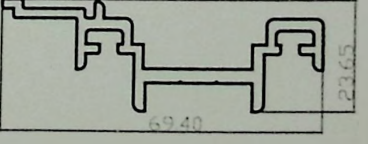
产品编号	断面图	产品编号	断面图
YT-SM51.1*50.95		YT-SM56.1*11.97	
YT-SM51.4*18.1		YT-SM56.1*11.97Y	
YT-SM51.4*33.05		YT-SM57*13.5	
YT-SM52.9*13.25		YT-SM59.35*11.41	
YT-SM55*30.68		YT-SM64.1*4.5	
		YT-SM67.4*9.78	
		YT-SM69.4*23.65	



# 产品规格 Product Specifications

产品编号	断面图	产品编号	断面图	产品编号	断面图
YT-KM13.6*7		YT-KM24.17*10		YT-KM30*18	
YT-KM12*11		YT-KM25.73*15.9		YT-KM30*11	
YT-KM12*11.5		YT-KM26*15		YT-KM30*13.8	
YT-KM16.5*12		YT-KM28.03*15.9		YT-KM30*28.17	
YT-KM20*12		YT-QK28.1*23.6		YT-KM30*38.2	
YT-KM20*17.55		YT-KM28.17*28		YT-KM30*42.3	
YT-KM22.6*15		YT-KM29*12		YT-KM30.74*15.55	
YT-KM22.98*9.53		YT-KM29*25.2			
YT-KM23*6.8					

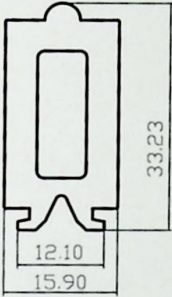
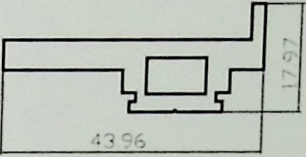
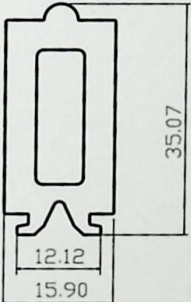
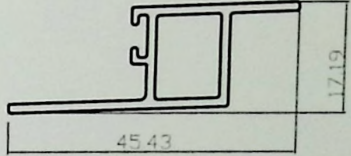
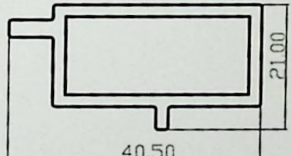
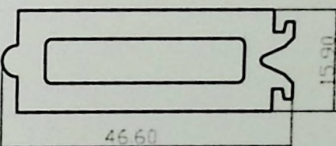
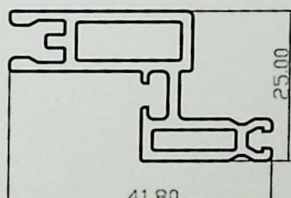
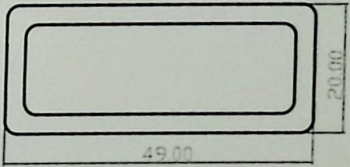
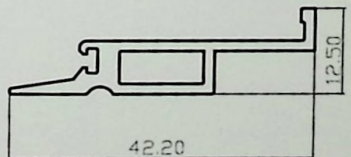
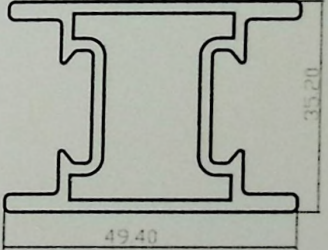
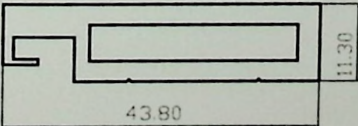
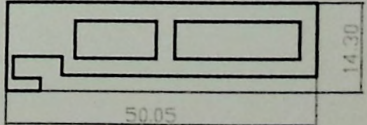
# 产品规格 Product Specifications

产品编号	断面图	产品编号	断面图
YT-KM33.2*15.9		YT-KM43.96*17.97	
YT-KM35.07*15.9		YT-KM45.43*17.19	
YT-KM40.5*21		YT-KM46.6*15.9	
YT-KM41.8*25		YT-KM49*20	
YT-KM42.2*12.5		YT-KM49.4*35.2	
YT-KM43.8*11.3		YT-KM50.05*14.3	

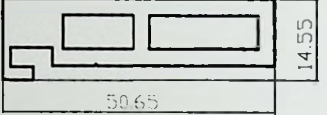
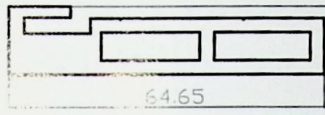
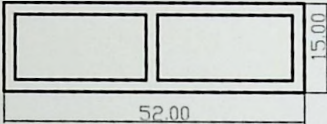
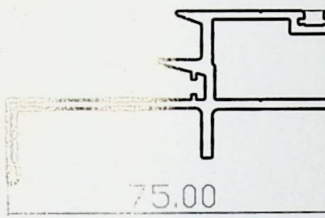
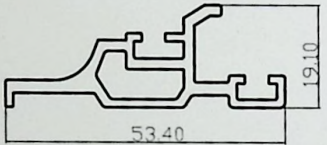
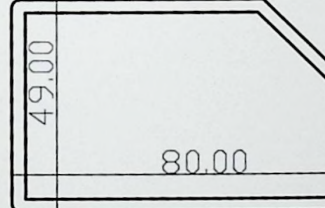
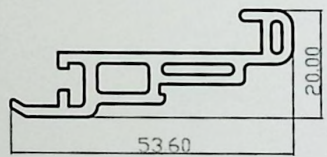
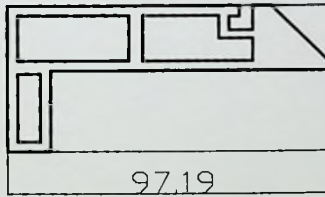
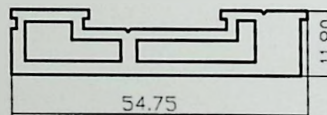
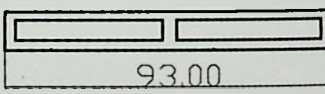
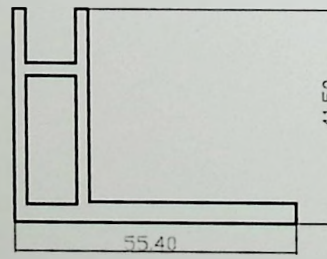
# 产品规格 Product Specifications

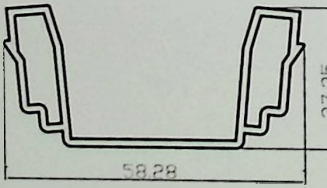
产品编号	断面图	产品编号	断面图
YT-KM50.65*14.55		YT-KM64.65*14.55	
YT-KM52*15		YT-KM75*40.8	
YT-KM53.4*19.1		YT-KM80*49	
YT-KM53.6*20		YT-KM97.19*45	
YT-KM54.75*11.8		YT-KM93*12	
YT-KM55.4*41.5		YT-H6.09*17.3	
YT-KM58.28*27.25			

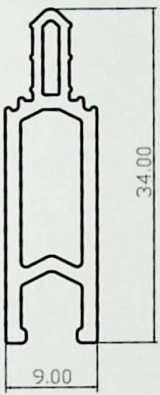
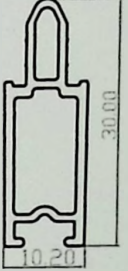
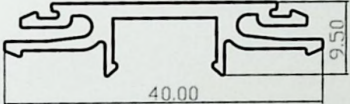
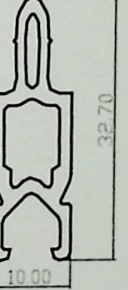
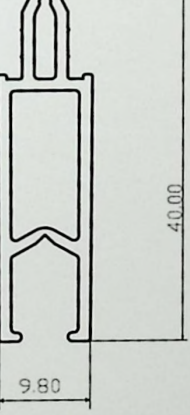
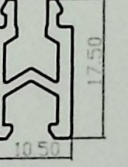
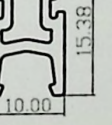
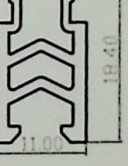
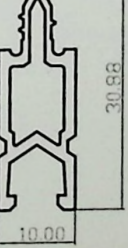
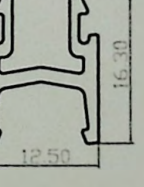

# 产品规格 Product Specifications

产品编号	断面图	产品编号	断面图
YT-H9*34		YT-H10*32.7	
YT-H9.5*40		YT-H10.2*30	
YT-H9.8*40		YT-H10.5*17.5	
YT-H10*15.38		YT-H11*18.4	
YT-H10*30.88		YT-H12.5*16.3	

# 产品规格 Product Specifications

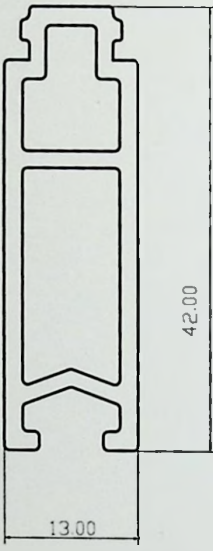
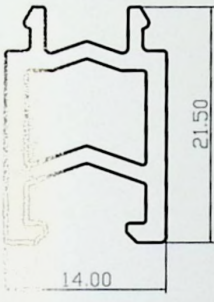
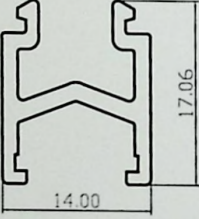
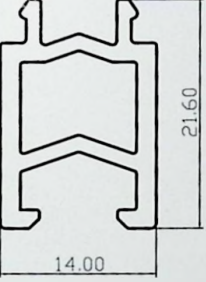
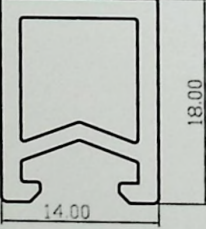
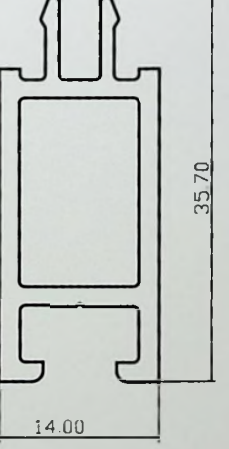
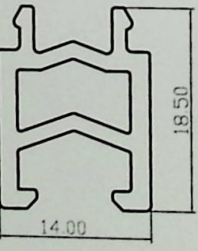
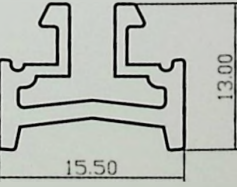
产品编号	断面图	产品编号	断面图
YT-H13*42		YT-H14*21.5	
YT-H14*17.06		YT-H14*21.6	
YT-H14*18		YT-H14*35.7	
YT-H14*18.5		YT-H15.5*13	

# 产品规格 Product Specifications

产品编号	断面图	产品编号	断面图
YT-H16*27	<p>16.00</p> <p>27.00</p>	YT-H18*40.52	<p>18.00</p> <p>40.52</p>
YT-H16*33	<p>16.00</p> <p>33.00</p>	YT-H20*40.75	<p>20.00</p> <p>40.75</p>
YT-H18*31.25	<p>18.00</p> <p>31.25</p>	YT-H20*46.75	<p>20.00</p> <p>46.75</p>

# 隔热条的作用以及它的特点

## Insulation effect and its characteristics

- 穿在内外两段铝型材之间，以减少热传导导热系数：

隔热型材的导热性比非隔热型材低

尼龙条（PA66+GF）导热系数：

- 提高舒适度

人体与环境交换热量，取决于室内空气的温度、流动速度和室外空气温度。正因为如此，通过隔热型材，调节门窗表面的温度，使之不低于12-13°C，以达到人体最舒适的环境。

- 保护环境

通过隔热系统的运用，能够减少能量的消耗，减少空调的使用，减少环境污染。

- 防止结露

合适的系统设计，会使隔热型材的内表面温度与室内温度接近，从而大大降低了室内过饱和的水分冷凝在型材内表面的可能性。

- 节能

在冬天减少热量向室外流失，降低采暖能耗；

在夏天减少热量向室内传递，降低制冷能耗；

- 隔音

适当的降低噪音污染。

- wear between the inner and outer two aluminum profile, in order to reduce the thermal conduction coefficient:

Thermal conductivity of non insulation material insulation material of low Nylon strip (PA66+GF) thermal conductivity:

- improve comfort

The human body heat exchange with ambient, depends on the indoor air temperature, velocity of flow and the outdoor air temperature. Because of this, the insulation material, adjusting the door window surface temperature, which is not lower than 12-13 °C, in order to achieve the most comfortable environment.

- Protect environment

Through the use of heat insulation system, can reduce energy consumption, reduce the use of air conditioning, reduce the pollution of the environment.

- to prevent condensation

A suitable system design, can make the thermal profiles of the inner surface temperature close to room temperature, which greatly reduces the possibility of indoor water condensation saturation surface in the profiles within the.

- The energy saving

In the winter to reduce heat loss to the outside, reduce the energy consumption for heating;

In the summer to reduce the heat to the indoor transmission, reduce the energy consumption;

- The sound insulation

Appropriate to reduce noise pollution.

## 保温原理 The principle of insulation

隔热穿条铝型材是由铝合金型材和热塑性混合材料隔热条组合而成。滚压式隔热铝合金型材是以隔热性能好的高密度聚酰胺PA66胶条，或聚氯乙烯硬质塑料胶条经穿条滚压加工，使铝、塑连成一体。发泡式隔热铝型材是利用隔热条把内、外层铝型材连接嵌装成一体，在形成的隔热腔内填充聚氨酯泡沫，成为隔热铝合金型材的“冷桥”，达到保温、节能的功效。

Thermal wear a aluminum is made of aluminum alloy sections and thermoplastic composite insulation assembly. Rolling type insulating aluminum profiles is based on high density polyamide PA66 plastic heat insulation performance is good, or rigid PVC plastic strip by strip rolling processing, aluminum, plastic as a whole. Foam thermal insulation aluminum profile is the use of insulation of the inner, outer aluminum connecting block is arranged into a whole, polyurethane foam insulation cavity formed in the insulating aluminum profiles, become the "cold bridge", achieve heat preservation, energy saving effect.

# 保温隔热给我们带来什么？

## Insulation what bring to us?

保温隔热可减少建物室内外热量的交换，对居住者最经济直观的感觉就是采暖及制冷费用的下降。下面以门窗为例。

图例：各种不同配置窗型铝门窗节能效果对比图。

Insulation can reduce the indoor and outdoor heat exchange building, down to residents the most economic and intuitive feeling is the feeling of heating and cooling costs. The doors and windows as an example. Example: comparison of energy-saving effect of different configuration window type aluminum door and window diagram.

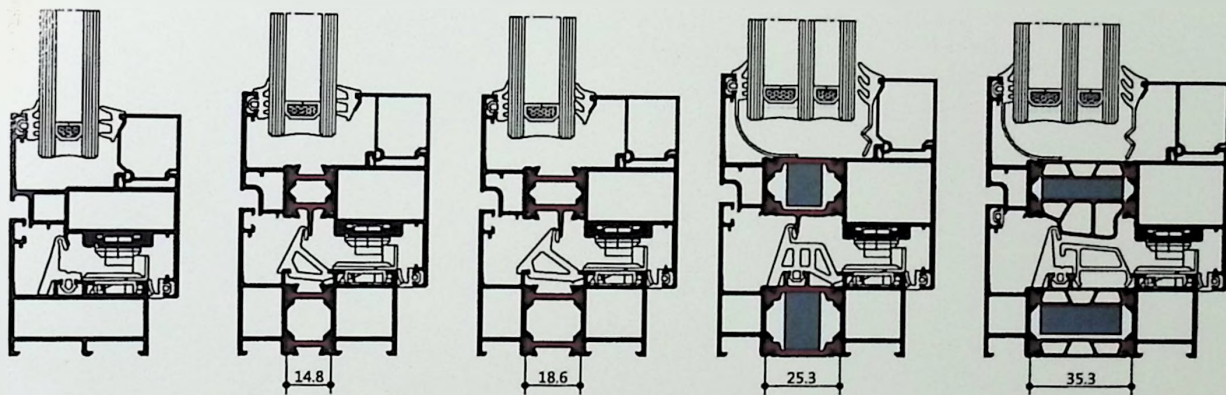

系统类型	普通中空玻璃铝窗	14.8mm隔热条	18.6mm隔热条	25.3mm隔热条加保温配置	35.3mm隔热条加何温配置
型材Uf (w/m <sup>2</sup> k)	6.8	3.6	3.0	2.6	1.9
玻璃类型	普玻	普玻	普玻充氩气	低辐射玻璃	低辐射玻璃充氩气
	5+9A+5	5+12A+5	5+12Ar+5	5Low-E+12A+4+9A+5	5Low E+12Ar+4+9Ar+5
玻璃Ug (w/m <sup>2</sup> k)	2.8	2.7	2.5	1.4	1.2
平均整窗Uw (w/m <sup>2</sup> k)	4.0	3.0	2.7	1.8	1.4
较普铝窗节约能源	38%	54%	58%	72%	78%

### 例二：

建筑面积为100m<sup>2</sup>的一套房子，建筑外门窗的面积20m<sup>2</sup>，以长江中下游一带的城市为例，一月份室内外小温差15度，使用一般普通中空玻璃铝合金门窗（Uw为4.0左右）与使用隔热断桥节能门窗（Uw为1.4左右）最直观的效果是：

保持同样室温所降低的能耗： $(4.0-1.4) \times 20 \times 15 = 780w$

即：对此户型，每小时节约0.78度电。

In two cases:

Construction area of 1002 sets of houses, area 20m<sup>2</sup> outside building doors and windows, in the middle and lower reaches of Yangtze River area of the city as an example, in January the indoor and outdoor low temperature 15 degrees, the use of ordinary insulating glass The aluminum alloy doors and windows (Uw 4) and the use of bridge insulation energy-saving windows and doors (Uw 1.4) effect of the most intuitive: Keep the same room temperature energy consumption reduced:  $(4.0-1.4) \times 20 \times 15 = 780w$

Namely: this apartment layout, saving 0.78 kwh per hour.

# 中国建筑热工数据分区图

China building thermal data partition map



## 原料鉴定 Material identification



# 技术支持 Technical Support

公司有从事多年专业设计开发的技术人员40余名,并设有化学和物理实验室,可为您提供以下技术服务:

Our company has over 40 technical staffs who have been engaged in R & D for many years. In addition, equipped with chemical and physics laboratories, our company can offer the following for our customers:

- 新型隔热系统的开发 New-type thermal barrier strips system development
- 隔热条U值电脑测试与传热分析 Thermal barrier strips material U-values measurement and thermal transmission analysis
- 隔热条U值热箱实测 U-values testing through computer of sample windows in hot boxes
- 隔热型材的机械性能及老化测试 Thermal barrier strips material mechanical property testing and aging testing
- 隔热条技术开发 New thermal barrier strips technology R & D

## 检测检验 Inspection and testing

公司设有化学和物理实验室,对每批生产的隔热条都进行严格的测试检验,并将检验报告同产品一同交给客户,让客户用的放心。

Equipped with chemical and physics laboratories, our company conducts strict testing of each batch of thermal barrier strips. We also present the testing report to our customers to set their heart at ease.

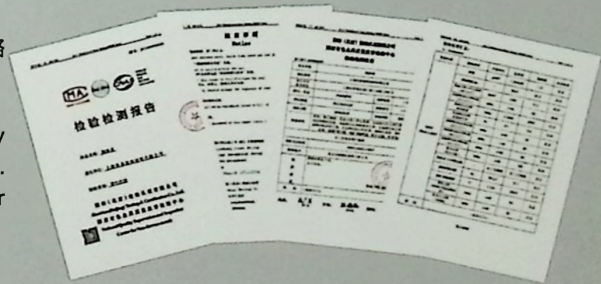

隔热条拉伸性能测试  
thermal barrier strips stretchability testing



隔热型材抗剪切性能测试  
thermal barrier strips anti-shearing property testing



隔热型材拉伸性能测试  
thermal barrier strips stretchability testing

# 技术支持 Technical Support

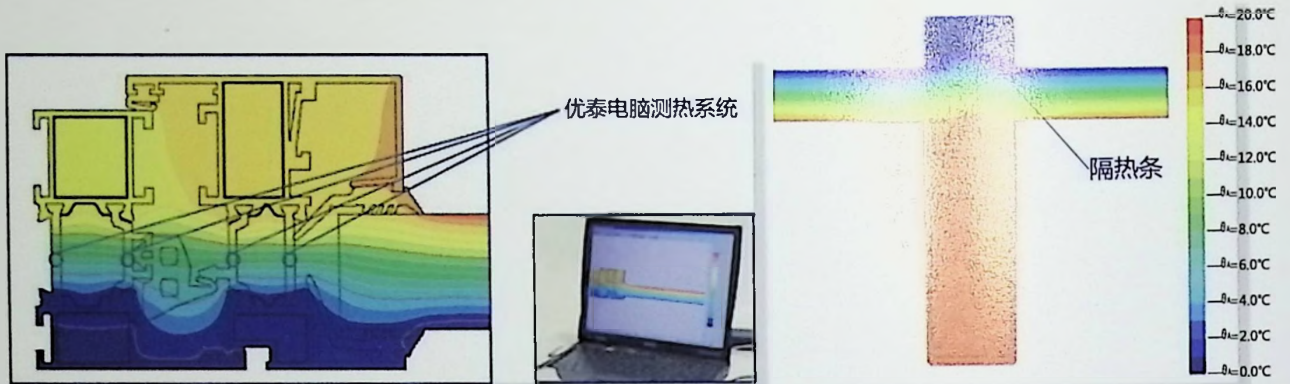

## 产品重要性 product importance

隔热条基材选择,聚酰胺 ( PA66 )

Thermal barrier strips substrate' s selection PA66

因其具备较高的机械强度；及具有耐高温、抗紫外线辐射、抗化学试剂腐蚀等性能,同时可保证产品尺寸精度的稳定性。

As the heat insulation base material for its mechanical strength, thermostability, corrosion resistance, and uvioresistance.

隔热条强化物的选择：玻璃纤维 ( GF )

Insulation reinforcer:GFInsulation reinforcer:GF

因其可以提高隔热条的强度已达到使用要求，同时可以让隔热条的线性膨胀系数与铝合金相近。

As the thermal barrier strips fortifier since it can make the strips' linear expansion coefficient approximate to that of aluminum alloy.

隔热条的生产加工工艺：玻璃纤维排列

The processing technics of thermal barrier strips: glass fiber arrangement

隔热条生产工艺中的核心技术:纠正部分玻璃纤维的排布方向(从纵向改为横向)

The core processing technology of thermal barrier strips: correct the arrangement of some glass fiber from vertical to horizontal.

合格玻璃纤维 Qualified GF



不合格玻璃纤维 Unqualified GF

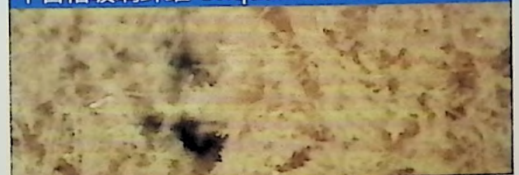

合格内部结构 Qualified internal structure



不合格内部结构 Unqualified internal structure

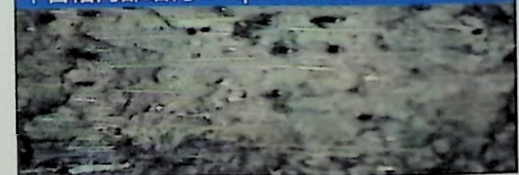



# 客户服务 Customer Service

“信誉至上、顾客第一”是我们永久的承诺，我们认为完善的服务同销量一样重要。以卓越的产品质量和良好的信誉，使用户满意是我公司一贯的服务宗旨。

It has always been our promise that “credibility is paramount and customers are foremost” since we believe good services are equally importance as sales volume. Also, we have consistently aimed to provide satisfactory services for customers with high-quality products and high credibility.

供货周期短：先进生产设备与成熟的生产工艺,保证了在最短的时间将优质的产品交付客户。常规品种齐全，备有现货。

Short delivery cycle: With advanced equipment and sophisticated processing technology, we guarantee high-quality delivery within a minimum amount of time. We have routine products in stock.

选择余地大：产品规格多达500多种供客户选择，选择空间大。另可以根据客户需要，开发新模具，满客户实际需求。

A wide range of choices: Customers have a widerange of choices of over 300 kinds of products. Besides, we can develop new moulds at customers' demand and to theirsatisfaction.

产品供应：采用订单制生产，根据客户要求，可进行定尺生产，避免材料浪费，节约客户成本，同时提高生产效率。

Convenient products supply: products are made in accordance with the order. Therefore, we can produce customized products with particular sizes, so as to consume less energy, lower cost for customers and increase productivity.

运输方式：送货上门，方便客户。

Delivery ways: home delivery services for customers' convenience



# 优化、改进 Optimization

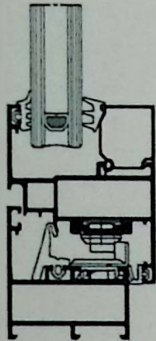

无隔热条设计  $U_f=6.9W/m^2k$   
(Design without thermal barrier strips)

高能耗 Energy-consuming  
易结露 Mixture condensation tendency  
高噪音 Excessive noise  
单一色 A single colour

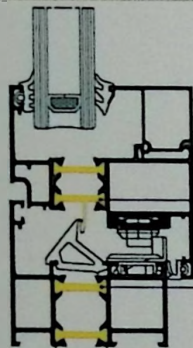

基本型隔热设计  $U_f=3.5W/m^2K$   
(Basic thermal barrier strips)

T型14.8mm隔热条 thermal barrier strips T14.8

I型14.8mm隔热条 thermal barrier strips I14.8

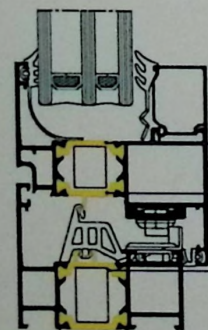

发展型隔热设计  $U_f=2.6W/m^2K$   
(Developmental thermal barrier strips)

C型25.3mm隔热条 thermal barrier strips C25.3

CT型25.3mm隔热条 thermal barrier strips CT25.3

CG型25.3mm隔热条 thermal barrier strips CG25.3

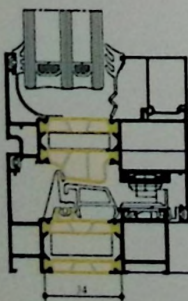

高端型隔热设计  $U_f=2.0W/m^2K$   
(Advanced thermal barrier strips)

HK-T型35.3mm隔热条 thermal barrier strips HK-T35.3

HK-G型35.3mm隔热条 thermal barrier strips HK-G35.3

HK型35.3mm隔热条 thermal barrier strips HK35.3

# 优化、改进 Optimization



隔热条宽度与Uf关系  
Relation between Uf value and strip width

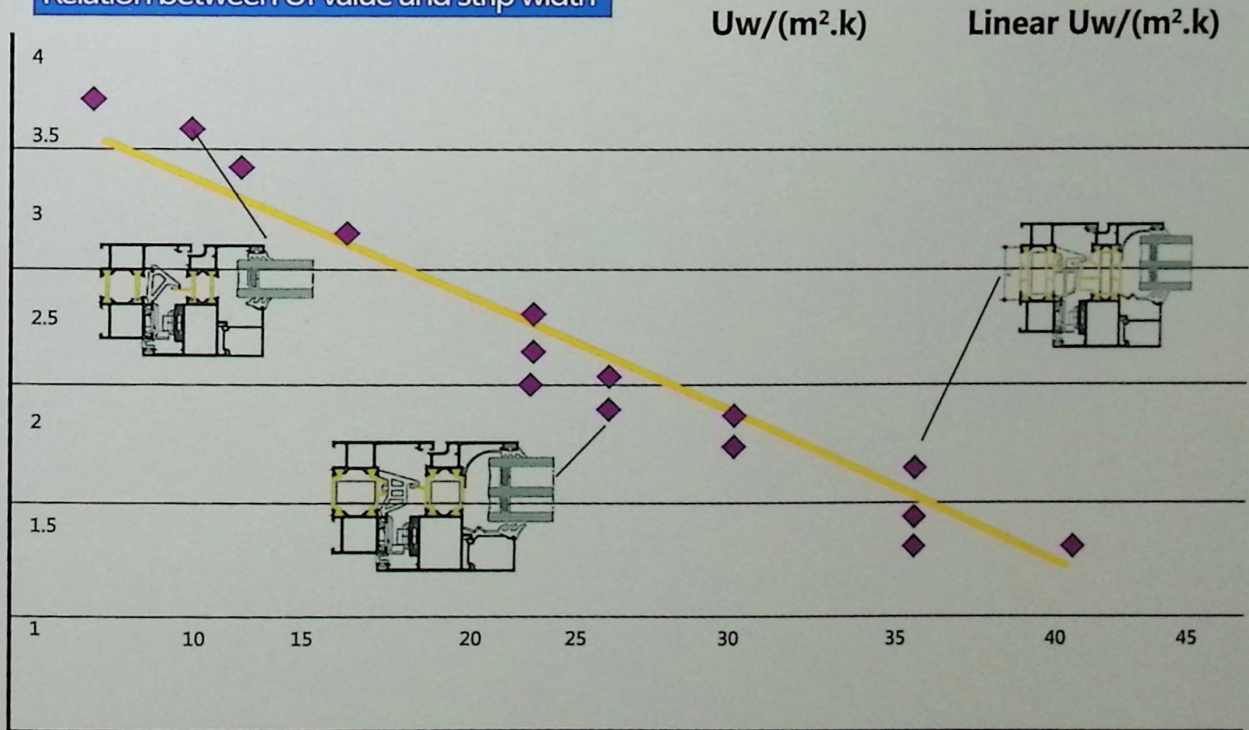

# 产品包装 Product Packaging



6米/支、6 m / branch

直条：产品每支长度为6米，50支或100支包装成一捆，外面用塑料包装带密封，在明显位置贴有产品标签和产品检验合格证。

Straight Strips: The length of every straight strip is 6 meters. Every 50 or 100 strips are bundled together, sealed with plastic packages. Product tags and inspection certificate are obviously presented.

卷装条：隔热条成卷包装每卷500米，外用编织带包装，每卷的明显位置贴有产品标签和产品检验合格证。

Rolled strips: Strips are rolled into reels and the length of each reel is 500 meters. The strip reels are wrapped with woven bags and Product tags and inspection certificate are obviously presented.



500米/盘、500 m / disc

可根据客户的具体要求进行定尺生产、包装、电脑激光喷码。

Products can be customized in terms of producing, packaging and computer laser coding.

## 激光喷码 Laser Coding

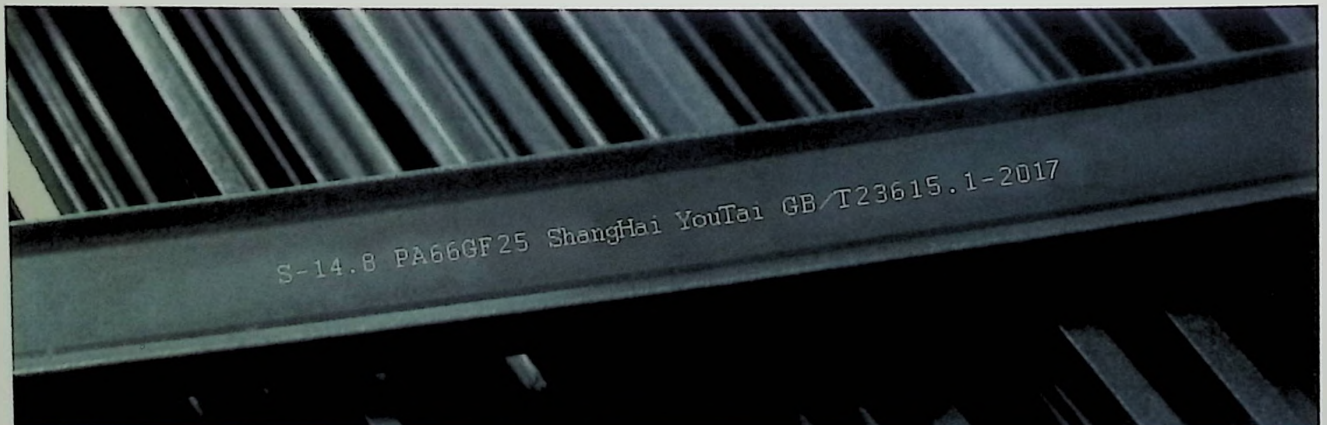

完美的数字激光喷码系统，精确追踪每一个有可能出问题的地方，做到防微杜渐。

# 物流配送 Logistics and distribution

尽心为您赢取优势 便捷顺畅安全安心。

Logistics distribution and delivery: competitively convenient, smoothly and safe delivery.

我们从客户的需求出发，完善自身的企业物流体系，能为价值链上的客户提供仓储、车队运输、船队运输等综合性物流服务，致力在货物流转过程中为客户提供增值服务，使物流成为客户的受益点。

Taking into consideration of customers' demand, we constantly improve our company's logistics system so as to provide integrated logistics services such as storage, land transportation as well as marine transportation for big customers. Meanwhile, we have always committed ourselves to create value for customers during the goods circulation.



## 使用说明 Instructions for usage

储存条件：建议贮存在通风、干燥环境中，水平放置，注意防水防雨，远离热源，避免重压，弯曲程度最小化，同时避免与酸、碱及有机溶剂接触。由于PA66是亲水性的物质，它会逐渐从周围环境中吸收水分。吸水的速度与吸水量，取决于下列因素：

Storage conditions: they are suggested to be placed levelly in a ventilated and moistureless location. Attention should be paid to protecting them from water or rain, heat producer, high pressure, excessive bending, acidic and alkaline liquidity as well as organic solvent, because PA66 is hydrophilic and tends to absorb moisture from its surroundings. The absorbing rate and volume are determined by the following factors

— 环境湿度 ---环境温度 ---储存时间

—Dampness ---temperature ---Storage time

夏季，天气的温度和相对湿度比较高，即使短期存放，隔热条吸收的水分也会比其他季节多。过高的含水率（超过2%）会影响穿条的质量。

In summer, the temperature is higher and the air is damper. Therefore, thermal barrier strips can absorb more water during a shorter period of storage time.Excessive moisture (over 2%) will exert influence on the quality of the strips.

单捆的隔热条被搬离货架时，有可能会扭曲变形，如果不及时校直，将会造成永久扭曲变形。

Single-bundled thermal barrier strips may be bended while moved away from the storage racks. It is necessary to straighten them, or the bend will be permanent.

如有任何具体问题，请与我们联系，我们很高兴为您提供相关服务。

Please contact us if you have specific questions. We will be happy to offer you relevant services.

# 工程案例 Project Cases



- ① 上海世博中国馆
- ② 北京国家开发银行
- ③ 北京中青旅大厦
- ④ 上海虹桥机场
- ⑤ 上海中心
- ⑥ 上海环球金融中心
- ⑦ 上海金茂大厦
- ⑧ 苏州中润广场
- ⑨ 大连城市广场
- ⑩ 上海港务大厦
- ⑪ 无锡集智广场
- ⑫ 上海虹桥机场西航站楼
- ⑬ 上海世博村B地块公寓酒店
- ⑭ 北京太平洋国际大厦
- ⑮ 迪拜劳力士写字楼

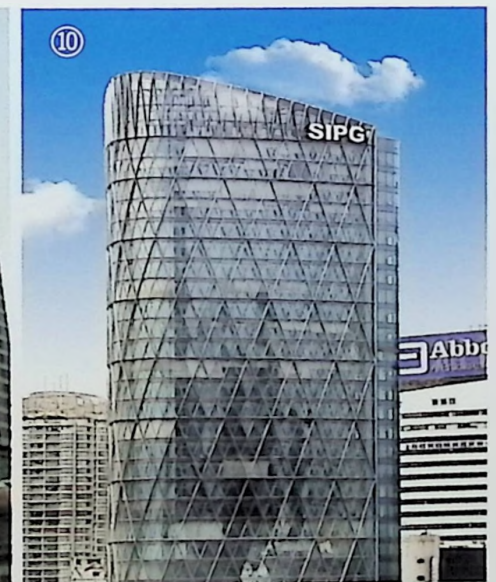

# 部分合作伙伴 Some of Our Business Partners

凤铝 	华建 	兴发  <b>兴发铝材</b> XINGFA ALUMINIUM PROFILES	坚美  坚美
博奥  <b>博奥铝业</b> BOAO ALUMINUM	栋梁 	鸿昌  <b>HCKJ</b>	科蓝特  <b>科蓝特铝材</b> 400-167-0563 www.kolangte-china.com
奋安  <b>奋安</b>	伟业  伟业	南平  闽铝	华昌  <b>WACANG</b> 华昌铝业
南山  NANSHAN	东城  华一	凯米特  凯米特	新河 
铭帝  铭帝	豪美  <b>HAOMEI</b> 豪美新材	西飞  AVIC	米皇 
亚铝  <b>AAG 亞鋁</b> GUANGYIN ASIALUM 亞鋁	山东伟业  <b>SHANYI</b> 山一铝材	闽发  <b>闽发铝业</b>	宣铝  宣铝铝业
三星  三星铝业 SANYING	浙东  <b>ZDOON</b>	富丽华  <b>富丽华铝业</b> FULLYWOW ALUMINIUM	和顺  <b>和顺铝业</b> HARMONIOUS
龙图 	生信  生信 SHENGXIN	广亚  <b>广亚铝材</b> 中国铝名商标 中国铝型材十强企业	天津金鹏  <b>金鹏</b> Kinbon



<http://www.shyoutai.com>

**上海总部/Headquarters in Shanghai:**

地址/Add : 上海市奉贤区金汇工业路1390号  
No.1390 Gongye Road, jinhui Town, Fengxian  
District, Shanghai  
电话/Tel : 021-54313217  
传真/Fax : 021-54313317  
手机/Mb: 13621833253  
邮编/Pc : 201404  
Web:www.shyoutai.com  
Email:shytlxy@163.com

**华北区/ North China:**

地址/Add : 北京市石景山区西黄村888号  
No.888 Xihuang Village,shijingshan Area,beijing  
手机 /Mb : 13621263256

**华南区/Southern China District:**

地址/Add : 广东省佛山市南海区大沥镇太平石步村  
Dali Town, Nanhai District, Guangdong Province  
Foshan Ping Shi Bu Cun  
电话/Tel : 0757-85512701  
手机/Mb : 15813695058

**华东区/East China:**

地址/Add : 上海市奉贤区金汇工业路1390号  
No.1390 Gongye Road, jinhui Town, Fengxian  
District, Shanghai  
手机/Mb: 13636693620

